

**Listino prezzi / Price-list / Liste des prix / Preisliste / Lista de precios
05.2026**

VELA	4
LOOK	27
LIKE	52
ALA / QUADRO / NOVO / UPRIGHT	66
MOVINGTRAY	78
MOVING ARM	80
PURA / PURAStudio	81
STERIL K	117
CART	135
ARMADI Cabinets / Armoires / Schränke / Armarios	139
BACINELLE Trays / Intérieurs de tiroir / Einsätze / Bandejas	141
PIANI Tops / Plans / Arbeitsplatten / Encimeras	145
ALZATINE Splashbacks / Dossierets / Aufkantungen / Alzadas	151
LAVELLI Sinks / Eviers / Waschbecken / Lavabos	153
RUBINETTI Mixers / Robinets / Wasserhähne / Grifos	157
LAVORAZIONI Customization	159
ACCESSORI Accessories / Accessoires / Zubehör / Accesorios	161
OPEN BOX	165
SEGGIOLINI Seats / Tabourets / Stühle / Sillas	166
PROF	169
MAESTRO	216
IMPIANTISTICA Plant construction / détails d'installation / anlagentechnik / plantas tecnicas	259
CONDIZIONI GENERALI DI VENDITA General terms of sale / Conditions générales de vente Allgemeine Verkaufsbedingungen / Condiciones generales de venta	277

MODULI

Aggiungere ad ogni elemento il prezzo del supporto a pavimento o a muro, del piano, dell'alzatina, del lavello e del rubinetto.

I moduli su misura possono essere realizzati solo con anta: applicare il prezzo dell'articolo di misura superiore con un supplemento del **25%**.

PENSILI E VETRINE

Pensili e vetrine su misura: applicare il prezzo dell'articolo di misura superiore con un supplemento del **25%**.

ATTENZIONE

Indicare sempre le misure delle apparecchiature che devono essere inserite nei moduli.

Le composizioni si intendono sempre a partire da sinistra verso destra. Specificare i colori di fusto, frontali e maniglie dei moduli.

Specificare dimensioni e tipo di piano, alzatina, lavello e rubinetto.

Composizioni lineari con canalina tecnica e lavello: utilizzare piani con profondità minima 520 mm.

Per composizioni con elementi ad angolo verificare la perpendicolarità delle pareti (90°): considerando la distanza di 80 cm su una parete e 60 cm sull'altra, la diagonale deve corrispondere a 100 cm.

Dimensioni: L = Larghezza P = Profondità H = Altezza

MANIGLIE ALLUMINIO

N.B.: solo in alluminio, **NO** verniciate.

SUPPORTI A PAVIMENTO

N.B.: In alluminio e verniciati.

CORIAN® e STRATIFICATO: solo di colore bianco.

MAGGIORAZIONI DI PREZZO PER COLORAZIONI SPECIALI

Colori RAL metallizzati/perlati e brillanti e in altri colori diversi dalla cartella RAL:

- **Supporto a pavimento/muro** (Vela pag. 16-17): supplemento + € 230,00
- **Kit di trasformazione in servomobile** (Vela pag. 15): supplemento + € 230,00
- **Serie frontali/anta**: supplemento per ogni mobile + € 130,00
- **Pannelli colorati Luna**: supplemento per ogni carrello + € 130,00.

SPESE IMBALLO: ogni collo € 20,00 prezzo netto.

UNITS

Add the floor support or wall support price, the top, splashback, sink and mixer prices to each unit.

Made-to-measure units: apply the price of the article with the next greater size and add a **25%** extra charge.

WALL UNITS AND DISPLAY CABINETS

Made-to-measure wall units and display cabinets: apply the price of the article with the next greater size and add a **25%** extra charge.

ATTENTION

Always provide the dimensions of the appliances that will be built into the units. The compositions are always understood as starting from the left to the right. Specify the colours of the unit, front panels and handles.

Specify the dimensions and type of top, splashback, sink and mixer.

Straight compositions with technical raceway and sink: use tops with minimum depth 520 mm.

For compositions with corner elements check that the walls are perfectly perpendicular (90°): considering the distance of 80 cm on the right and 60 cm left hand sides of the corner, the diagonal line must be 100 cm.

Dimensions: L = Width P = Depth
H = Height

ALUMINIUM HANDLE

Attention: only aluminium, **NOT** painted.

FLOOR SUPPORT

Attention: aluminium and painted.

CORIAN® and STRATIFIED: only in white color.

UPCHARGES FOR SPECIAL COLORS

Metallized/pearl and luminous RAL colors and other different colors from the RAL colors:

- **Floor/wall support** (Vela page 16-17): upcharge + € 230,00
- **Sides for movable unit** (Vela page 15) : upcharge + € 230,00
- **Fronts/door**: upcharge for each unit + € 130,00
- **Painted panels Luna**: upcharge for each trolley + € 130,00

PACKING COSTS:

each package € 20,00 net price

MODULES

À chaque module il faut ajouter le prix de support au sol au support ou mur, plan, dossier, évier et robinet. Les modules sur mesure peuvent être réalisés uniquement avec une porte: appliquer le prix de l'article de mesure supérieure et ajouter un supplément de 25%.

ÉLÉMENTS MURAUX ET VITRINES

Éléments suspendus et vitrines sur mesure: appliquer le prix de l'article de mesure supérieure et ajouter un supplément de 25%.

ATTENTION

Indiquer obligatoirement les mesures exactes des appareils destinés à être introduits dans les meubles. Les compositions s'entendent toujours en partant de gauche vers la droite. Spécifier les couleurs du corps, des façades et des poignées des modules. Spécifier les dimensions et le type du plan, du dossier, du lavabo et du robinet. Compositions linéaires avec canalisation technique et évier: utiliser des plans ayant une profondeur minimale de 520 mm. Pour les compositions avec des éléments d'angle, contrôler soigneusement la perpendicularité des murs (90°): si on prend la distance exacte de 80 cm à droite et 60 cm à gauche de l'angle, la diagonale devra mesurer 100 cm.

Dimensions: L = Largeur P = Profondeur
H = Hauteur

POIGNÉE EN ALUMINIUM

Attention: en aluminium, PAS peint.

SUPPORTS AU SOL

Attention: en aluminium et peint.

CORIAN® et STRATIFIE': en couleur blanc seulement.

SUPPLÉMENTS DE PRIX POUR COULEURS SPÉCIALES

Couleurs RAL métallisés/pearl et lumineux et d'autres couleurs différentes des couleurs RAL:
- Support au sol/au mur (Vela page 16-17): supplément de prix + € 230,00
- Côtés pour module mobile (Vela page 15): supplément de prix + € 230,00
- Façades/porte: supplément de prix pour chaque module + € 130,00
- Panneaux peints Luna: supplément de prix pour chaque chariot + € 130,00

FRAIS D'EMBALLAGE:

prix net de chaque colis € 20,00

SCHRÄNKE

Bei jedem Element muss der Preis der Bodengestell oder der Wandbefestigung, der Arbeitsplatte, der Aufkantung, der Spüle und der Wasserhahn separat berechnet werden.

Maßgefertigte Schränke können nur mit Tür hergestellt werden: auf den Preis des nächst größeren Artikels einen Mehrpreis von 25% berechnen.

HÄNGESCHRÄNKE UND VITRINEN

Maßgefertigte Hängeschränke und Vitrinen: auf den Preis des nächst größeren Artikels einen Mehrpreis von 25% berechnen.

VORSICHT

Immer die Maße der Geräte angeben, die in die Schränke eingebaut werden. Die Anbaulösungen sind immer von links nach rechts angegeben. Die Farben des Korpus, der Fronten und der Griffe der Schränke angeben. Abmessungen und Art der Arbeitsplatte, Aufkantung, Spüle und Wasserhahn angeben. Lineare Anbaulösungen mit Technikkanal und Spüle: Arbeitsplatten mit einer Mindesttiefe von 520 mm verwenden. Bei Anbaulösungen mit ECKELEMEN- TEN auf lotrechte (90°) Wände achten: bei einem Abstand von 80 cm rechts und 60 cm links von der Ecke muss die Diagonale 100 cm betragen.

Abmessungen: L = Breite P = Tief
H = Höhe

ALUMINIUMGRIFF

Bitte beachten: Aluminium, NICHT lackiert.

BODENGESTELL

Bitte beachten: Aluminium und lackiert.

CORIAN® und SCHICHTSTOFF: nur weiß.

AUFPREIS FÜR SONDERFARBEN

Metallic/Perl und leuchtende RAL-Farben und anderen verschiedenen Farben der RAL-Farben:
- Bodengestell/Wandbefestigung (Vela Seite 16-17): Aufpreis + € 230,00
- Seiten für Rollenschrank (Vela Seite 15): Aufpreis + € 230,00
- Fronten/Tür: Aufpreis für jede Schrank + € 130,00
- Lackierte Paneel Luna: Aufpreis für jede Wagen + € 130,00

VERPACKUNGSKOSTEN:

jedes Paket € 20,00 Nettopreis

MÓDULOS

Añadir a cada elemento el precio del soporte de pie o del soporte en pared, de la encimera, de la alzada, del lavabo y del grifo.

Los muebles a la medida pueden realizarse sólo con la puerta: aplicar el precio del artículo de medida superior con un recargo del 25%.

MUEBLES COLGANTES Y VITRINAS

Muebles colgantes y vitrinas a la medida: aplicar el precio del artículo de medida superior con un recargo del 25%.

ATENCIÓN

Indicar siempre las medidas de los equipos que deben introducirse en los módulos. Las composiciones se consideran siempre a partir de la izquierda hacia la derecha. Especificar los colores del módulo, de los frentes y de los tiradores. Especificar las dimensiones y el tipo de encimera, de alzada, de lavabo y de grifo. Composiciones lineales con canal técnico y lavabo: utilizar encimeras con 520 mm de profundidad mínima. Para composiciones con elementos en ángulo controlar la perpendicularidad de las paredes (90°): considerando la distancia de 80 cm a la dcha. y 60 cm a la izq., del ángulo, la diagonal debe corresponder a 100 cm.

Dimensiones: L = Ancho P = Profundidad
H = Alto

TIRADOR DE ALUMINIUM

Atención: en aluminio, no pinta.

SOPORTE DE PIE

Atención: en aluminio y pinta.

CORIAN® y ESTRATIFICADO: de color blanco.

CARGOS ADICIONAL PARA COLORACIONES ESPECIALES

Colores RAL metalizados/perla y brillantes y otros colores diferentes de colores RAL:
- Soporte de pie/en pared (Vela página 16-17): cargo adicional + € 230,00
- Laterales para modulo móvil (Vela página 15): cargo adicional + € 230,00
- Frentes/puerta: cargo adicional por cada módulo + € 130,00
- Paneles pintados Luna: cargo adicional por cada carro + € 130,00

EMBALAJE:

cada paquete € 20,00 precio neto

Finiture verniciate / Painted finishes / Finitions peintes / Lackierten Ausführungen / Acabados pintados

*Nuovi colori Loran / New Loran colors / Nouvelles couleurs Loran/ Neue Loran-Farben / Nuevos colores Loran

RAL 7045	RAL 8019	RAL 9001	RAL 9002	RAL 9005	SILBER
RAL 6000	RAL 6019	RAL 6027	RAL 7016	RAL 7022	RAL 7038
RAL 5002	RAL 5010	RAL 5012	RAL 5014	RAL 5022	RAL 5024
RAL3000	RAL 3004	RAL 3016	RAL 4002	RAL 4006	RAL 5000
BIANCO	RAL 1015	RAL 1018	RAL 1023	RAL 2001	RAL 2012
NEVE	CIELO	AGAVE	EUCALIPTO		
LINO	CUOIO				

*Colorazioni speciali con maggiorazione di prezzo / Special colors with upcharge
Couleurs spéciales avec supplément de prix / Sonderfarben gegen einem Aufpreis
Coloraciones especiales disponibles por un cargo adicional

COLORI PIANI IN VETRO / Colors of the glass tops / Couleurs des plans en verre / Farben der Glasarbeitsplatten / Colores de las encimeras de vidrio

TURCHESE	LIMONE	VERDE ACQUA	VERDE
CELESTE	BLU CINA	ROSSO GRANATA	ROSSO VENEZIANO

Vetro extra-chiaro / Extra clear glass / Verre transparent / Transparen Glas / Vidrio transparente

GIALLO	AZZURRO MEDITERRANEO	GLICINE
SALMONE	GIALLO NEVADA	BIANCO

Disponibile in tutti i colori RAL / Available in all RAL colors

Questo campionario deve essere considerato solo come guida indicativa del colore e non può essere utilizzato come riferimento originale per la produzione e la valutazione di superfici colorate.

This sample should only be considered as an indicative colour guide and cannot be used as an original reference for the production and assessment of colored surfaces.

Ce nuancier ne sert qu'à donner une idée des différents coloris et ne doit en aucun cas être utilisé comme référence originale pour la production et l'évaluation des surfaces colorées.

Diese Farbmuster sind unverbindlich und können vom Original Farbton der hergestellten Oberflächen abweichen.

Esta muestra de colores debe considerarse sólo como una guía indicativa del color, y no puede utilizarse como referencia original para la producción y evaluación de las superficies pintadas.

VELA
LOOK
LIKE
ALA/QUADRO NOVO/UPRIGHT
MOVINGTRAY MOVING ARM
PURAS PURASTUDIO
STERIL K
CART
ARMADI
BACINELLE
PIANI ALZATINE
LAVELLI RUBINETTI
LAVORAZIONI ACCESSORI
OPEN BOX SEGGIOLINI
PROF
MAESTRO
IMPIANTISTICA

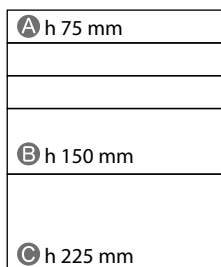
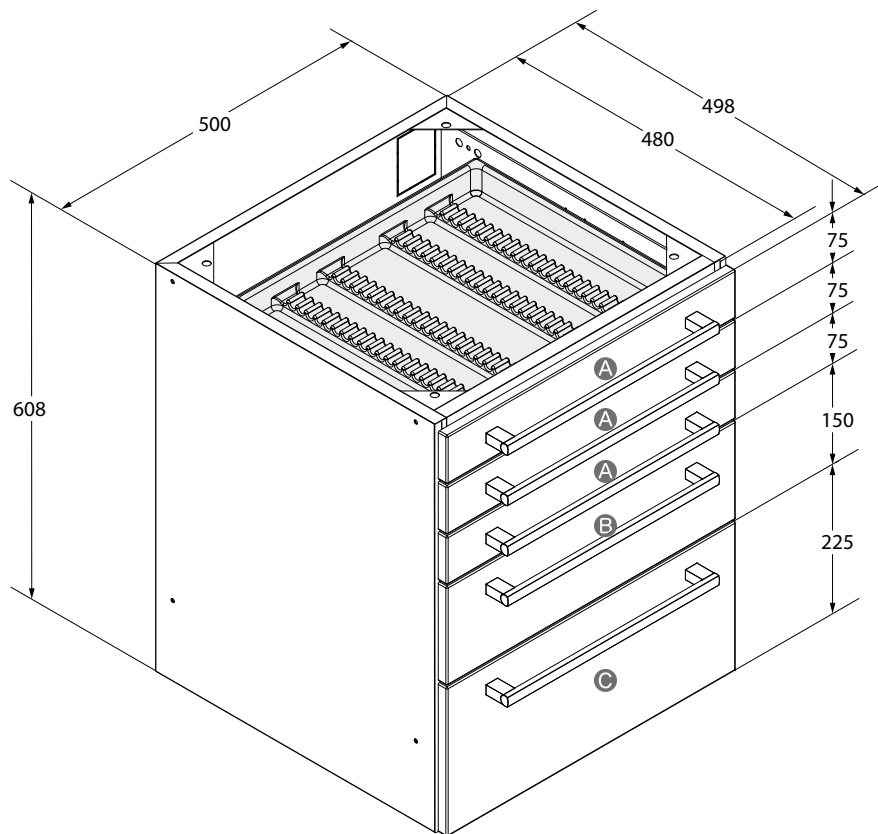

Cassetti
Drawers / Tiroirs
Schubladen / Cajones

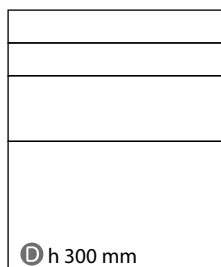

Cassetti
Drawers / Tiroirs
Schubladen / Cajones

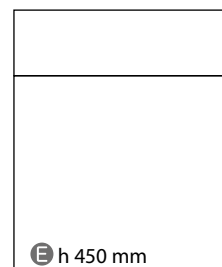

Modulo sottolavello
Sink unit / Module lavabo
Waschbeckenschrank
Módulo bajo lavabo

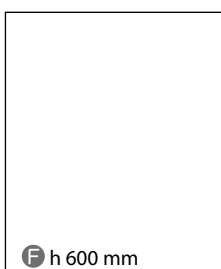

Anta
Door / Porte
Tür / Puerta

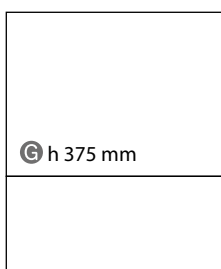

Anta a ribalta
Hide-away door
Porte basculante
Versenkbare Tür
Puerta escamoteable

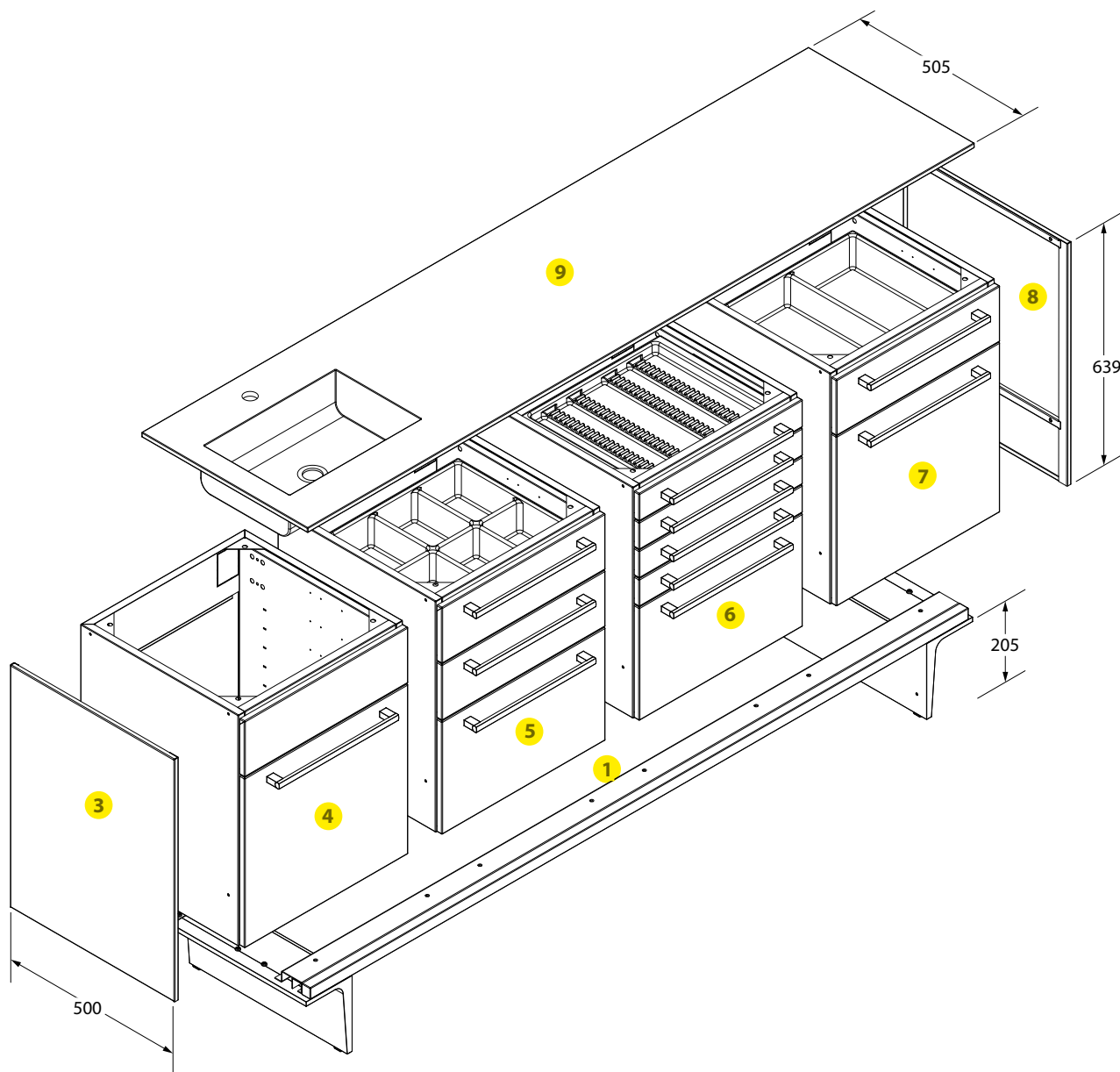

MOBILE VELA

- 1 Supporto a pavimento
- 2 Bordo di finitura per versione a muro
- 3 Fianco laterale
- 4 Mobile lavello
- 5 Mobile con 2 cassetti B + 1D
- 6 Mobile con 4 cassetti A + 1D
- 7 Mobile con 1 cassetto B + anta
- 8 Fianco terminale dx
- 9 Piano con lavello sx
- 10 Sistema di aggancio per versione a muro

H Sottopiano 846 mm

UNIT VELA

- 1 Floor support
- 2 Finish profile for wall support
- 3 Lateral side LH
- 4 Sink unit
- 5 Unit with 2 drawers B + 1 D
- 6 Unit with 4 drawers A + 1 D
- 7 Unit with 1 drawer B + door
- 8 Lateral side RH
- 9 Top with sink on the left side
- 10 Coupling system for wall support

H Under the top 846 mm

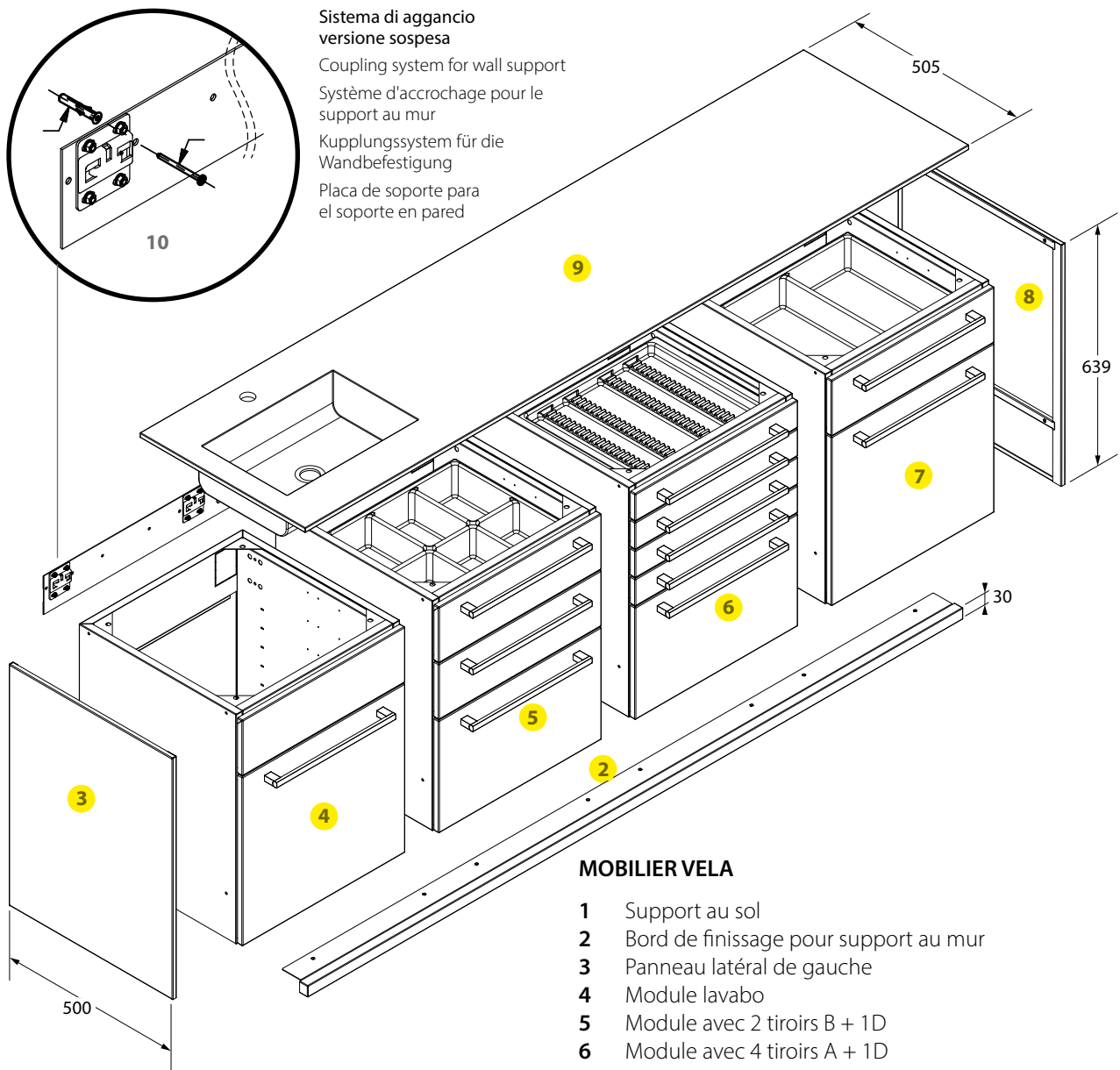

Sistema di aggancio versione sospesa
Coupling system for wall support
Système d'accrochage pour le support au mur
Kuplungssystem für die Wandbefestigung
Placa de soporte para el soporte en pared

MOBILIER VELA

- 1 Support au sol
- 2 Bord de finissage pour support au mur
- 3 Panneau latéral de gauche
- 4 Module lavabo
- 5 Module avec 2 tiroirs B + 1D
- 6 Module avec 4 tiroirs A + 1D
- 7 Module avec 1 tiroir B et porte
- 8 Panneau latéral de droite
- 9 Plan avec évier à gauche
- 10 Système d'accrochage pour le support au mur

H Sous plan de travail 846 mm

VELA-MÖBEL

- 1 Bodengestell
- 2 Abschlussleiste für die Wandbefestigung
- 3 Seitenwand links
- 4 Waschbeckenschrank
- 5 Schrank mit 2 Schubladen B und 1 D
- 6 Schrank mit 4 Schubladen A und 1 D
- 7 Schrank mit 1 Schublade B und Tür
- 8 Seitenwand rechts
- 9 Arbeitsplatte mit Waschbecken links
- 10 Kupplungssystem für die Wandbefestigung

H Unter der Arbeitsplatte 846 mm

MUEBLE VELA

- 1 Soporte de pie
- 2 Borde de acabado para soporte en pared
- 3 Panel lateral izq.
- 4 Módulo bajo lavabo
- 5 Módulo con 2 cajones B + 1D
- 6 Módulo con 4 cajones A + 1D
- 7 Módulo con 1 cajón B + puerta
- 8 Panel lateral dcho.
- 9 Encimera con lavabo izq.
- 10 Placa de soporte para el soporte en pared

A Bajo encimera 846 mm

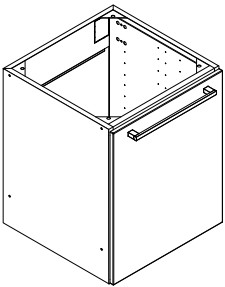
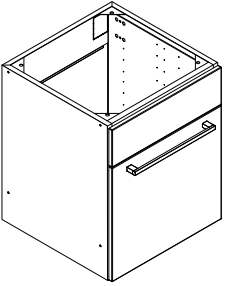
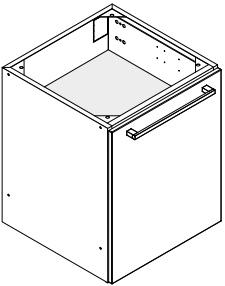
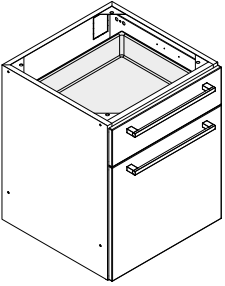
	Descrizione / Description Description / Beschreibung / Descripción	Apertura Opening / Ouverture Öffnung / Apertura	M³ Kg	Articolo Item / Article Artikel / Artículo	Prezzo Price / Prix Preis / Precio
 <p>MODULO sottolavello con anta e portarifiuti interno Sink unit with door and rubbish bin Module lavabo avec porte et poubelle Waschbeckenschrank mit Tür und Abfalleimer Módulo lavabo con puerta y cubo de basura</p> <p>L 500 x P 498 x H 608 mm</p>		Maniglia Handle Poignée Griff Tirador	0,25 ----- 20,5	VLAM	€ 580,00
		Push-Pull	0,25 ----- 20,3	VLAP	€ 558,00
 <p>MODULO sottolavello con frontale fisso e anta "VLB" o con cassetto estraibile "VLC", con portarifiuti interno Sink unit with fixed front and door "VLB" or pullout drawer "VLC", with rubbish bin Module lavabo avec façade fixe et porte "VLB" ou grand tiroir extractible "VLC", avec poubelle Waschbeckenschrank mit fest Frontplatte und Tür "VLB" oder Schublade "VLC", mit Abfalleimer Módulo lavabo con frente fijo y puerta "VLB" o cajon "VLC", con cubo de basura</p> <p>L 500 x P 498 x H 608 mm</p>		Maniglia Handle Poignée Griff Tirador	0,25 ----- 21	VLBM	€ 632,00
		Maniglia Handle Poignée Griff Tirador	0,25 ----- 25,5	VLCM	€ 749,00
		Maniglia Handle Poignée Griff Tirador	0,25 ----- 20,8	VLBP	€ 597,00
		Push-Pull	0,25 ----- 25,3	VLCP	€ 714,00
 <p>MODULO con anta e due ripiani interni Unit with door and 2 interior shelves Module avec porte et 2 étagères internes Schrank mit Tür und 2 Einlegeböden Módulo con puerta y dos estantes interiores</p> <p>L 500 x P 498 x H 608 mm</p>		Maniglia Handle Poignée Griff Tirador	0,25 ----- 20,5	VPAM	€ 553,00
		Push-Pull	0,25 ----- 20,3	VPAP	€ 534,00
 <p>MODULO con cassetto B e anta con 1 ripiano interno Unit with drawer B and door with an interior shelf Module avec 1 tiroir B et porte avec 1 étagère à l'intérieur Schrank mit 1 Schublade B und Tür mit 1 Einlegeboden Módulo con cajón B y puerta con 1 estante interior</p> <p>L 500 x P 498 x H 608 mm</p>		Maniglia Handle Poignée Griff Tirador	0,25 ----- 25	VPBM	€ 690,00
		Push-Pull	0,25 ----- 24,6	VPBP	€ 722,00

VELA

LOOK

LIKE

ALA / QUADRO
NOVO / UPRIGHTMOVINGTRAY
MOVING ARMPURA
PURASTUDIO

STERIL K

CART

ARMADI

BACINELLE

PIANI
ALZATINELAVELLI
RUBINETTILAVORAZIONI
ACCESSORIOPEN BOX
SEGGIOLINI

PROF

MAESTRO

IMPIANTISTICA

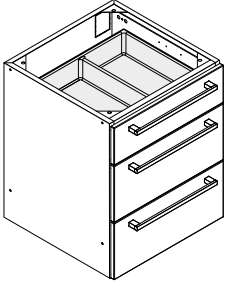
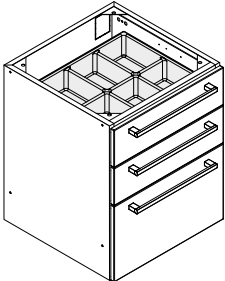
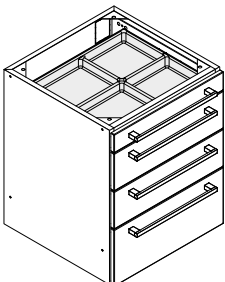
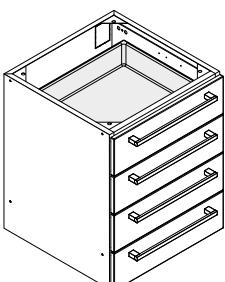
	Descrizione / Description Description / Beschreibung / Descripción	Apertura Opening / Ouverture Öffnung / Apertura	M ³ Kg	Articolo Item / Article Artikel / Artículo	Prezzo Price / Prix Preis / Precio
 <p>MODULO con 3 cassetti: 1 B e 2 C Unit with 3 drawers: 1 B and 2 C Module avec 3 tiroirs: 1 B et 2 C Schrank mit 3 Schubladen: 1 B und 2 C Módulo con 3 cajones: 1 B y 2 C</p> <p>Bacinelle / Trays / Intérieurs de tiroir / Einsätze / Bandejas: 1xVBB2, 2xVBC1</p> <p>L 500 x P 498 x H 608 mm</p>		Maniglia Handle Poignée Griff Tirador	0,25 35,2	V3AM	€ 960,00
		Push-Pull	0,25 34,6	V3AP	€ 1.058,00
 <p>MODULO con 3 cassetti: 2 B e 1 D Unit with 3 drawers: 2 B and 1 D Module avec 3 tiroirs: 2 B et 1 D Schrank mit 3 Schubladen: 2 B und 1 D Módulo con 3 cajones: 2 B y 1 D</p> <p>Bacinelle / Trays / Intérieurs de tiroir / Einsätze / Bandejas: 1xVBB2, 1xVBB4, 1xVBC1</p> <p>L 500 x P 498 x H 608 mm</p>		Maniglia Handle Poignée Griff Tirador	0,25 35	V3BM	€ 967,00
		Push-Pull	0,25 34,4	V3BP	€ 1.064,00
 <p>MODULO con 4 cassetti: 1 A, 2 B e 1 C Unit with 4 drawers: 1 A, 2 B and 1 C Module avec 4 tiroirs: 1 A, 2 B et 1 C Schrank mit 4 Schubladen: 1 A, 2 B und 1 C Módulo con 4 cajones: 1 A, 2B y 1 C</p> <p>Bacinelle / Trays / Intérieurs de tiroir / Einsätze / Bandejas: 1xVBA3, 1xVBB1, 1xVBB2, 1xVBC1</p> <p>L 500 x P 498 x H 608 mm</p>		Maniglia Handle Poignée Griff Tirador	0,25 40,2	V4AM	€ 1.088,00
		Push-Pull	0,25 39,4	V4AP	€ 1.218,00
 <p>MODULO con 4 cassetti: 4 B Unit with 4 drawers: 4 B Module avec 4 tiroirs: 4 B Schrank mit 4 Schubladen: 4 B Módulo con 4 cajones: 4 B</p> <p>Bacinelle / Trays / Intérieurs de tiroir / Einsätze / Bandejas: 1xVBB1, 1xVBB2, 1xVBB3, 1xVBB4</p> <p>L 500 x P 498 x H 608 mm</p>		Maniglia Handle Poignée Griff Tirador	0,25 40,4	V4BM	€ 1.074,00
		Push-Pull	0,25 39,6	V4BP	€ 1.203,00

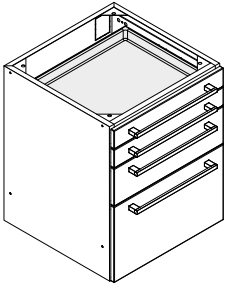
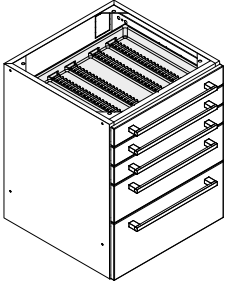
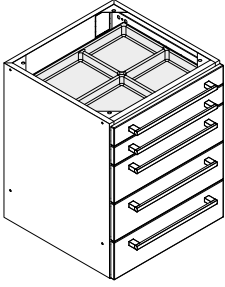
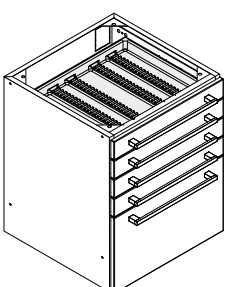
	Descrizione / Description Description / Beschreibung / Descripción	Apertura Opening / Ouverture Öffnung / Apertura	M³ Kg	Articolo Item / Article Artikel / Artículo	Prezzo Price / Prix Preis / Precio
 <p>MODULO con 4 cassetti: 2 A, 1 B e 1 D Unit with 4 drawers: 2 A, 1 B and 1 D Module avec 4 tiroirs: 2 A, 1 B et 1 D Schrank mit 4 Schubladen: 2 A, 1 B und 1 D Módulo con 4 cajones: 2 A, 1 B y 1 D</p> <p>Bacinelle / Trays / Intérieurs de tiroir / Einsätze / Bandejas: 1xVBA2, 1xVBA4, 1xVBB4, 1xVBC1</p> <p>L 500 x P 498 x H 608 mm</p>	<p>Maniglia Handle Poignée Griff Tirador</p> <p>0,25 39,8</p> <p>V4CM</p> <p>€ 1.086,00</p>				
	<p>Push-Pull</p> <p>0,25 39</p> <p>V4CP</p> <p>€ 1.215,00</p>				
 <p>MODULO con 5 cassetti: 3 A, 1 B e 1 C Unit with 5 drawers: 3 A, 1 B and 1 C Module avec 5 tiroirs: 3 A, 1 B et 1 C Schrank mit 5 Schubladen: 3 A, 1 B und 1 C Módulo con 5 cajones: 3 A, 1 B y 1 C</p> <p>Bacinelle / Trays / Intérieurs de tiroir Einsätze / Bandejas: 1xVBA1, 1xVBA3, 1xVBA4, 1xVBB1, 1xVBC1</p> <p>L 500 x P 498 x H 608 mm</p>	<p>Maniglia Handle Poignée Griff Tirador</p> <p>0,25 45</p> <p>V5AM</p> <p>€ 1.228,00</p>				
	<p>Push-Pull</p> <p>0,25 44</p> <p>V5AP</p> <p>€ 1.390,00</p>				
 <p>MODULO con 5 cassetti: 2 A e 3 B Unit with 5 drawers: 2 A and 3 B Module avec 5 tiroirs: 2 A et 3 B Schrank mit 5 Schubladen: 2 A und 3 B Módulo con 5 cajones: 2 A y 3 B</p> <p>Bacinelle / Trays / Intérieurs de tiroir Einsätze / Bandejas: 1xVBA3, 1xVBA4, 1xVBB1, 1xVBB2, 1xVBB4</p> <p>L 500 x P 498 x H 608 mm</p>	<p>Maniglia Handle Poignée Griff Tirador</p> <p>0,25 45,2</p> <p>V5BM</p> <p>€ 1.213,00</p>				
	<p>Push-Pull</p> <p>0,25 44,2</p> <p>V5BP</p> <p>€ 1.376,00</p>				
 <p>MODULO con 5 cassetti: 4 A e 1 D Unit with 5 drawers: 4 A and 1 D Module avec 5 tiroirs: 4 A et 1 D Schrank mit 5 Schubladen: 4 A und 1 D Módulo con 5 cajones: 4 A y 1 D</p> <p>Bacinelle / Trays / Intérieurs de tiroir Einsätze / Bandejas: 1xVBA1, 1xVBA2, 1xVBA3, 1xVBA4, 1xVBC1</p> <p>L 500 x P 498 x H 608 mm</p>	<p>Maniglia Handle Poignée Griff Tirador</p> <p>0,25 44,6</p> <p>V5CM</p> <p>€ 1.223,00</p>				
	<p>Push-Pull</p> <p>0,25 43,6</p> <p>V5CP</p> <p>€ 1.387,00</p>				

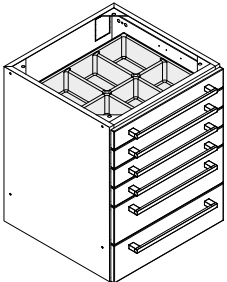
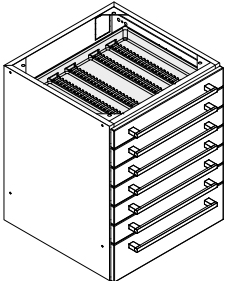
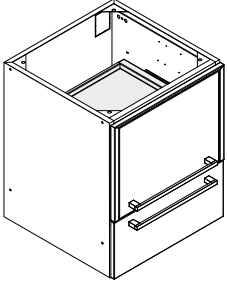
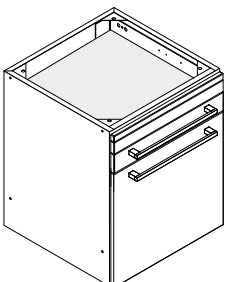
	Descrizione / Description Description / Beschreibung / Descripción	Apertura Opening / Ouverture Öffnung / Apertura	M ³ Kg	Articolo Item / Article Artikel / Artículo	Prezzo Price / Prix Preis / Precio
 <p>MODULO con 6 cassetti: 4 A e 2 B Unit with 6 drawers: 4 A and 2 B Module avec 6 tiroirs: 4 A et 2 B Schrank mit 6 Schubladen: 4 A und 2 B Módulo con 6 cajones: 4 A y 2 B</p> <p>Bacinelle / Trays / Intérieurs de tiroir / Einsätze / Bandejas: 1xVBA1, 1xVBA2, 1xVBA3, 1xVBA4, 1xVBB1, 1xVBB4</p> <p>L 500 x P 498 x H 608 mm</p>	<p>Maniglia Handle Poignée Griff Tirador</p>	0,25 50	V6AM	€ 1.354,00	
	<p>Push-Pull</p>	0,25 48,8	V6AP	€ 1.549,00	
 <p>MODULO con 7 cassetti: 6 A e 1 B Unit with 7 drawers: 6 A and 1 B Module avec 7 tiroirs: 6 A et 1 B Schrank mit 7 Schubladen: 6 A et 1 B Módulo con 7 cajones: 6 A y 1 B</p> <p>Bacinelle / Trays / Intérieurs de tiroir / Einsätze / Bandejas: 1xVBA1, 2xVBA2, 2xVBA3, 1xVBA4, 1xVBB3</p> <p>L 500 x P 498 x H 608 mm</p>	<p>Maniglia Handle Poignée Griff Tirador</p>	0,25 54,8	V7AM	€ 1.495,00	
	<p>Push-Pull</p>	0,25 53,4	V7AP	€ 1.723,00	
 <p>MODULO con anta a ribalta con 2 ripiani estraibili per apparecchiature + ciabatta con 3 prese di corrente e cassetto C Unit with hide-away door equipped with 2 apparatus storage shelves + 3 Schuko sockets and 1 drawer C Module avec porte basculante avec 2 tiroirs pour appareils + 3 prises de courant Schuko et 1 tiroir C Schrank mit versenkbarer Tür mit 2 Geräteeinlagen + 3 Schuko-Steckdosen und 1 Schublade C Módulo con puerta plegable con 2 estantes extraíbles para equipos + regleta con 3 tomas de corriente Schuko y cajón C</p> <p>L 500 x P 498 x H 608 mm</p>	<p>Maniglia Handle Poignée Griff Tirador</p>	0,25 33	VRAM	€ 1.183,00	
	<p>Push-Pull</p>	0,25 32,6	VRAP	€ 1.280,00	
 <p>MODULO PC con cassetto A per tastiera (L 385 - H 25 mm max), 1 cassetto A e anta, con schiena aperta Unit for PC with 1 drawer A for keyboard (L - H), 1 drawer A and door, open back Module pour PC avec 1 tiroir A pour clavier (L - H), 1 tiroir A et porte, ouvert derrière Schrank für PC mit 1 Schublade A für Tastatür (L - H), 1 Schublade A und Tür, Rückwand geöffnet Módulo PC con 1 cajón A porta teclado (L - H), 1 cajón A y puerta, con panel trasero abierto</p> <p>L 500 x P 498 x H 608 mm</p>	<p>Maniglia Handle Poignée Griff Tirador</p>	0,25 25	VPCM	€ 717,00	
	<p>Push-Pull</p>	0,25 24,8	VPCP	€ 748,00	

VELA

LOOK

LIKE

ALA / QUADRO
NOVO / UPRIGHTMOVINGTRAY
MOVING ARMPURA
PURASTUDIO

STERIL K

CART

ARMADI

BACINELLE

PIANI
ALZATINELAVELLI
RUBINETTILAVORAZIONI
ACCESSORIOPEN BOX
SEGGIOLINI

PROF

MAESTRO

IMPIANTISTICA

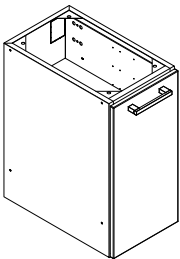
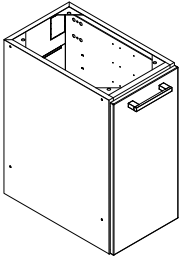
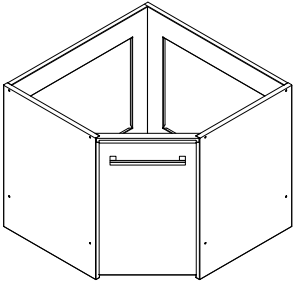
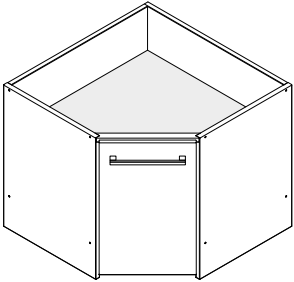
	Descrizione / Description Description / Beschreibung / Descripción	Apertura Opening / Ouverture Öffnung / Apertura	M ³ Kg	Articolo Item / Article Artikel / Artículo	Prezzo Price / Prix Preis / Precio
 <p>MODULO con anta e due ripiani interni</p> <p>Unit with door and 2 interior shelves</p> <p>Module avec porte et 2 étagères internes</p> <p>Schrank mit Tür und 2 Einlegeböden</p> <p>Módulo con puerta y dos estantes interiores</p> <p>L 300/400 x P 498 x H 608 mm</p>		Maniglia Handle Poignée Griff Tirador	0,25 16	VPDM (L. 300 mm)	€ 553,00
			0,25 17	VPGM (L. 400 mm)	€ 553,00
			0,25 15,9	VPDP (L. 300 mm)	€ 534,00
		Push-Pull	0,25 16,9	VPGP (L. 400 mm)	€ 534,00
 <p>MODULO con anta e due ripiani interni, con schiena aperta</p> <p>Unit with door and 2 interior shelves, open back</p> <p>Module avec porte et 2 étagères internes, ouvert derrière</p> <p>Schrank mit Tür und 2 Einlegeböden, Rückwand geöffnet</p> <p>Módulo con puerta y dos estantes interiores, con panel trasero abierto</p> <p>L 300 x P 498 x H 608 mm</p>		Maniglia Handle Poignée Griff Tirador	0,25 15,5	VPEM	€ 580,00
		Push-Pull	0,23 15,4	VPEP	€ 558,00
 <p>MODULO angolare sottolavello con anta e portarifiuti interno</p> <p>Corner sink unit with door and rubbish bin</p> <p>Module lavabo d'angle avec porte et poubelle</p> <p>Eckwaschbeckenschrank mit Tür und Abfalleimer</p> <p>Módulo angular lavabo con puerta y cubo de basura</p> <p>L 750 x P 750 x H 608 mm</p>		Maniglia Handle Poignée Griff Tirador	0,70 17,5	VAAM	€ 699,00
		Push-Pull	0,70 17,4	VAAP	€ 678,00
 <p>MODULO angolare con anta e 1 ripiano interno</p> <p>Corner unit with door and 1 interior shelf</p> <p>Module d'angle avec porte et 1 étagère interne</p> <p>Eckschrank mit Tür und 1 Einlegeboden</p> <p>Módulo angular con puerta y estante interior</p> <p>L 750 x P 750 x H 608 mm</p>		Maniglia Handle Poignée Griff Tirador	0,70 22	VACM	€ 699,00
		Push-Pull	0,70 21,9	VACP	€ 678,00

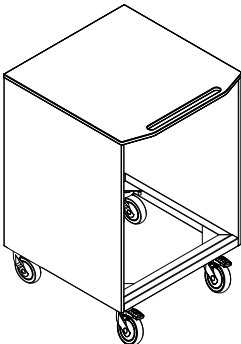
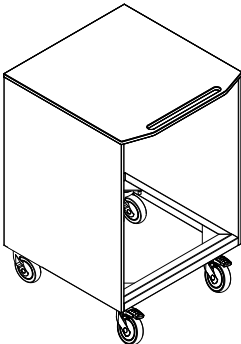
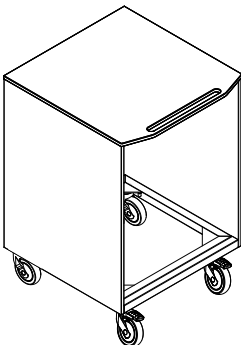
	Descrizione / Description Description / Beschreibung / Descripción	Fianchi Sides / Côtés Seiten / Laterales	M ³ Kg	Articolo Item / Article Artikel / Artículo	Prezzo Price / Prix Preis / Precio
 <p>Kit ruote + piano sagomato in Corian® bianco</p> <p>Castor set + shaped white Corian® top Kit roues + plan façonné en Corian® blanc Rollenset + Arbeitsplatte aus geformtem weißem Corian® Kit de ruedas + encimera perfilada de Corian® blanco</p> <p>L 528 x P 555 x H 787 mm</p>	<p>Verniciato Painted / Verni Lackiert Pintado</p>	0,08 21	KRCV	€ 613,00	
	<p>Stratificato Stratified / Stratifié Schichtstoff Estratificado</p>	0,08 26,4	KRCS	€ 1.081,00	
	<p>Corian®</p>	0,08 28	KRCC	€ 1.334,00	
 <p>Kit ruote + piano sagomato in stratificato bianco</p> <p>Castor set + shaped white stratified top Kit roues + plan façonné en stratifié blanc Rollenset + Arbeitsplatte aus geformtem weißem Schichtstoff Kit de ruedas + encimera perfilada de estratificado blanco</p> <p>L 528 x P 555 x H 787 mm</p>	<p>Verniciato Painted / Verni Lackiert Pintado</p>	0,08 20,3	KRSV	€ 578,00	
	<p>Stratificato Stratified / Stratifié Schichtstoff Estratificado</p>	0,08 25,7	KRSS	€ 1.043,00	
	<p>Corian®</p>	0,08 27,3	KRSC	€ 1.297,00	
 <p>Kit ruote + piano sagomato in vetro</p> <p>Castor set + shaped glass top Kit roues + plan façonné en verre Rollenset + geformte Glasarbeitsplatte Kit de ruedas + encimera perfilada de vidrio</p> <p>L 528 x P 555 x H 790 mm</p>	<p>Verniciato Painted / Verni Lackiert Pintado</p>	0,08 25,6	KRVV	€ 728,00	
	<p>Stratificato Stratified / Stratifié Schichtstoff Estratificado</p>	0,08 31	KRVS	€ 1.176,00	
	<p>Corian®</p>	0,08 32,6	KRVC	€ 1.428,00	
	<p>MAGGIORAZIONI per piano in vetro</p> <p>Additional charge for glass top Supplément de prix pour plan en verre Aufpreis für Glasarbeitsplatte Cargo adicional para encimera de vidrio</p>	<p>Extra-chiaro Extra clear Transparent Transparent Trasparente</p>			€ + 82,00
		<p>Satinato Satin / Dépoli Satinert Satinado</p>			€ + 88,00

VELA | Supporti a pavimento

Floor supports / Supports au sol / Bodengestelle / Soportes de pie

LORAN

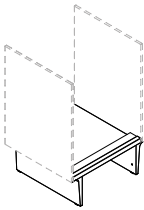
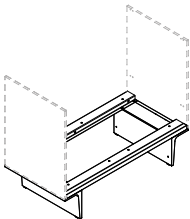
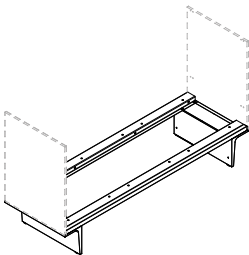
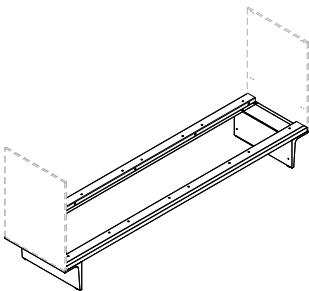
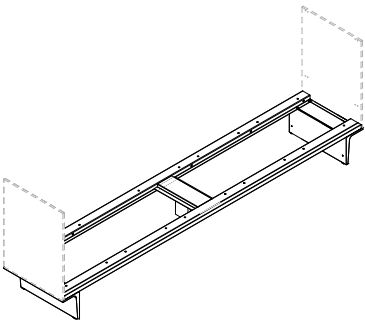
	Descrizione / Description Description / Beschreibung / Descripción	M ³ Kg	Articolo Item / Article Artikel / Artículo	Prezzo Price / Prix Preis / Precio
 <p>L 500 mm</p>	SUPPORTO a pavimento per 1 modulo Floor support for 1 unit Support au sol pour 1 module Bodengestell für 1 Schrank Soporte de pie para 1 módulo	0,14 19	VS1V	€ 769,00
		0,14 19	VS1S	€ 1.264,00
		0,14 19	VS1C	€ 1.550,00
 <p>L 1000 mm</p>	SUPPORTO a pavimento per 2 moduli Floor support for 2 units Support au sol pour 2 modules Bodengestell für 2 Schränke Soporte de pie para 2 módulos	0,26 27	VS2V	€ 769,00
		0,26 27	VS2S	€ 1.264,00
		0,26 27	VS2C	€ 1.550,00
 <p>L 1500 mm</p>	SUPPORTO a pavimento per 3 moduli Floor support for 3 units Support au sol pour 3 modules Bodengestell für 3 Schränke Soporte de pie para 3 módulos	0,35 31	VS3V	€ 800,00
		0,35 31	VS3S	€ 1.382,00
		0,35 31	VS3C	€ 1.667,00
 <p>L 2000 mm</p>	SUPPORTO a pavimento per 4 moduli Floor support for 4 units Support au sol pour 4 modules Bodengestell für 4 Schränke Soporte de pie para 4 módulos	0,40 35	VS4V	€ 833,00
		0,40 35	VS4S	€ 1.496,00
		0,40 35	VS4C	€ 1.782,00
 <p>L 2500 mm</p>	SUPPORTO a pavimento per 5 moduli Floor support for 5 units Support au sol pour 5 modules Bodengestell für 5 Schränke Soporte de pie para 5 módulos	0,54 51,5	VS5V	€ 940,00
		0,54 51,5	VS5S	€ 1.684,00
		0,54 51,5	VS5C	€ 1.970,00

VELA

LOOK

LIKE

ALA/QUADRO
NOVO/UPRIGHTMOVINGTRAY
MOVING ARMPURA
PURASTUDIO

STERIL K

CART

ARMADI

BACINELLE

PIANI
ALZATINELAVELLI
RUBINETTILAVORAZIONI
ACCESSORIOPEN BOX
SEGGIOLINI

PROF

MAESTRO

IMPIANTISTICA

VELA | Supporti a muro

LORAN

Wall supports / Supports au mur / Wandbefestigungen / Soportes de pared

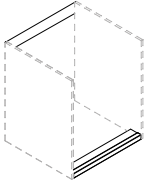
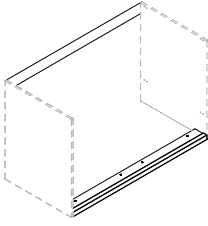
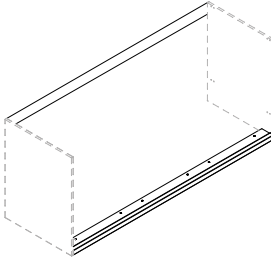
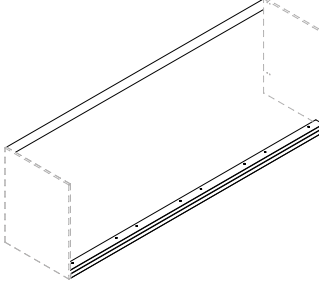
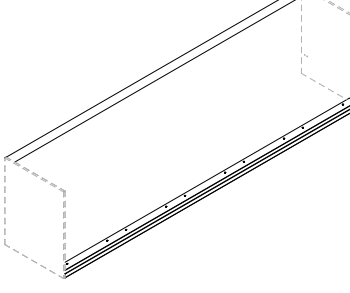
	Descrizione / Description Description / Beschreibung / Descripción	M ³ Kg	Articolo Item / Article Artikel / Artículo	Prezzo Price / Prix Preis / Precio
 <p>L 500 mm</p>	SUPPORTO a muro per 1 modulo Wall support for 1 unit Support au mur pour 1 module Wandbefestigung für 1 Schrank Soporte de pared para 1 módulo	0,01 4,5	VM1V	€ 162,00
		0,01 4,5	VM1S	€ 548,00
		0,01 4,5	VM1C	€ 873,00
 <p>L 1000 mm</p>	SUPPORTO a muro per 2 moduli Wall support for 2 units Support au mur pour 2 modules Wandbefestigung für 2 Schränke Soporte de pared para 2 módulos	0,02 7	VM2V	€ 175,00
		0,02 7	VM2S	€ 673,00
		0,02 7	VM2C	€ 957,00
 <p>L 1500 mm</p>	SUPPORTO a muro per 3 moduli Wall support for 3 units Support au mur pour 3 modules Wandbefestigung für 3 Schränke Soporte de pared para 3 módulos	0,03 8,5	VM3V	€ 199,00
		0,03 8,5	VM3S	€ 779,00
		0,03 8,5	VM3C	€ 1.065,00
 <p>L 2000 mm</p>	SUPPORTO a muro per 4 moduli Wall support for 4 units Support au mur pour 4 modules Wandbefestigung für 4 Schränke Soporte de pared para 4 módulos	0,04 10,5	VM4V	€ 223,00
		0,04 10,5	VM4S	€ 886,00
		0,04 10,5	VM4C	€ 1.172,00
 <p>L 2500 mm</p>	SUPPORTO a muro per 5 moduli Wall support for 5 units Support au mur pour 5 modules Wandbefestigung für 5 Schränke Soporte de pared para 5 módulos	0,05 12,5	VM5V	€ 248,00
		0,05 12,5	VM5S	€ 992,00
		0,05 12,5	VM5C	€ 1.279,00

VELA

LOOK

LIKE

ALA/QUADRO
NOVO/UPRIGHT

MOVINGTRAY
MOVING ARM

PURA
PURASTUDIO

STERIL K

CART

ARMADI

BACINELLE

PIANI
ALZATINE

LAVELLI
RUBINETTI

LAVORAZIONI
ACCESSORI

OPEN BOX
SEGGIOLINI

PROF

MAESTRO

IMPIANTISTICA

VELA | Basamenti

Base units / Bases / Sockel / Bases

LORAN

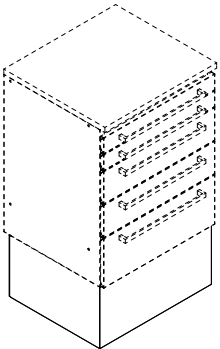
	Descrizione / Description Description / Beschreibung / Descripción	M ³ Kg	Articolo Item / Article Artikel / Artículo	Prezzo Price / Prix Preis / Precio
	Basamento angolare Corner base unit - Base d'angle Ecksockel - Base angular	- 6,5	VB01	€ 232,00
	Basamento / Base unit / Base Sockel / Base: L 300	- 3	VB02	€ 112,00
	Basamento / Base unit / Base Sockel / Base: L 400	- 4	VB06	€ 112,00
	Basamento / Base unit / Base Sockel / Base: L 500	- 5	VB03	€ 140,00

VELA | Fianchi Sides / Côtés / Seiten / Laterales

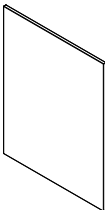
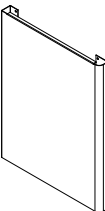
	Descrizione / Description Description / Beschreibung / Descripción	Fianchi Sides / Côtés Seiten / Laterales	M ³ Kg	Articolo Item / Article Artikel / Artículo	Prezzo Price / Prix Preis / Precio	
	P 500 x H 639 mm SP 14 mm	Verniciato Painted / Verni Lackiert / Pintado	- 3,5	VFV	€ 69,00	
	P 500 x H 639 mm SP 12 mm	FIANCO laterale Lateral side Panneau latéral Seitenwand Panel lateral	Stratificato Stratified / Stratifié Schichtstoff Estratificado	- 6,1	VFS	€ 279,00
	P 500 x H 639 mm SP 12 mm		Corian®	- 6,9	VFC	€ 394,00
	P 595 x H 639 mm SP 14 mm		Verniciato Painted / Verni Lackiert / Pintado	- 4	VFV60	€ 184,00
	P 500 x H 639/650 mm SP 46 mm	Fianco laterale Round Round lateral side Panneau latéral Round Round Seitenwand Panel lateral Round	Verniciato Painted / Verni Lackiert / Pintado	- 5,2	VFVR	€ 184,00
	P 595 x H 639/650 mm SP 12 mm	Verniciato Painted / Verni Lackiert / Pintado	- 6,2	VFV60R	€ 184,00	

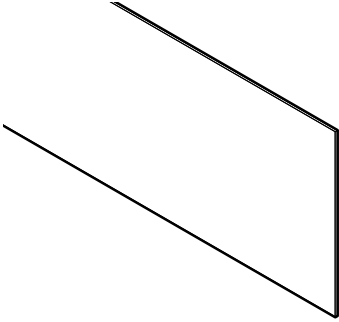
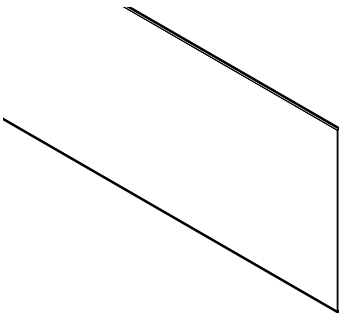
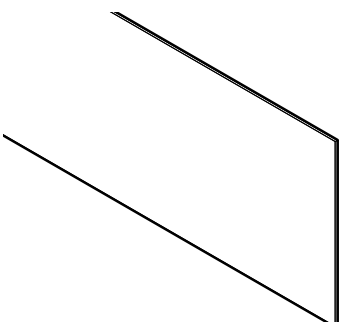
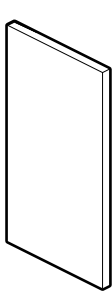
	Descrizione / Description Description / Beschreibung / Descripción	M ³ Kg	Articolo Item / Article Artikel / Artículo	Prezzo Price / Prix Preis / Precio
 <p>P 12 x H 638 mm</p>	<p>Tamponamento posteriore verniciato: al metro lineare</p> <p>Painted closing back panel: per meter Cache de fermeture à l'arrière, verni: au mètre Lackierte Verschlussverkleidung: je Meter Panel trasero, pintado: al m.</p>	- 5	VTV	€ 183,00
 <p>P 12 x H 638 mm</p>	<p>Tamponamento posteriore in stratificato: al metro lineare</p> <p>Stratified closing back panel: per meter Cache de fermeture à l'arrière, en stratifié: au mètre Verschlussverkleidung aus Schichtstoff: je Meter Panel trasero, de estratificado: al m.</p>	- 8	VTS	€ 543,00
 <p>P 12 x H 638 mm</p>	<p>Tamponamento posteriore in Corian®: al metro lineare</p> <p>Corian® closing back panel: per meter Cache de fermeture à l'arrière, en Corian®: au mètre Verschlussverkleidung aus Corian®: je Meter Panel trasero, de Corian®: al m.</p>	- 10	WTVC	€ 718,00
 <p>L 30 x P 480 x H 843 mm</p>	<p>Pannello laterale verniciato di sostegno piano</p> <p>Painted top-support side panel Panneau latéral verni, de support pour le plan Lackierte Abschlussverkleidung Panel lateral pintado para el soporte de la encimera</p>	- 8	VSLs	€ 184,00

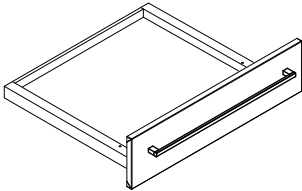
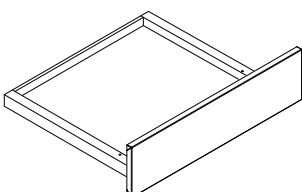
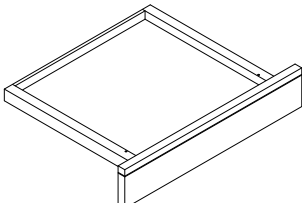
	Descrizione / Description Description / Beschreibung / Descripción	M³ Kg	Articolo Item / Article Artikel / Artículo	Prezzo Price / Prix Preis / Precio	
	CASSETTO con maniglia Drawer with handle Tiroir avec poignée Schublade mit Griff Cajón con tirador	-			
		A) H 75	5,7	VCAAM	€ 158,00
		B) H 150	6,6	VCABM	€ 176,00
		C) H 225	7,3	VCACM	€ 206,00
		-			
		D) H 300	7,8	VCADM	€ 218,00
	CASSETTO Push-Pull Drawer Push-Pull Tiroir Push-Pull Schublade Push-Pull Cajón Push-Pull	-			
		A) H 75	5,5	VCAAP	€ 188,00
		B) H 150	6,4	VCABP	€ 208,00
		C) H 225	7,1	VCACP	€ 238,00
		-			
		D) H 300	7,6	VCADP	€ 251,00
	CASSETTO per tastiera (L 385 - H 25 mm max) Drawer for keyboard (L 385 - H 30 mm) Tiroir pour clavier (L 385 - H 30 mm) Schublade für Tastatur (L 385 - H 30 mm) Cajón porta teclado (L 385 - H 30 mm)	-			
		A) H 75	5,5	VCAAPK	€ 250,00

VELA

LOOK

LIKE

ALA / QUADRO
NOVO / UPRIGHTMOVINGTRAY
MOVING ARMPURA
PURASTUDIO

STERIL K

CART

ARMADI

BACINELLE



PIANI
ALZATINELAVELLI
RUBINETTILAVORAZIONI
ACCESSORIOPEN BOX
SEGGIOLINI

PROF

MAESTRO

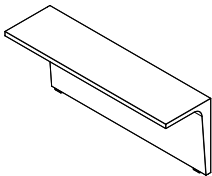
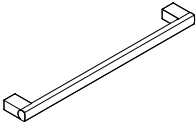
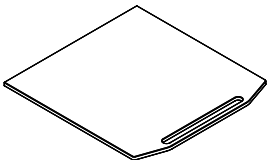
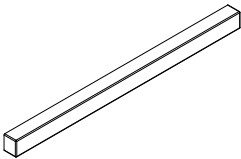
IMPIANTISTICA

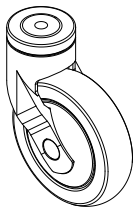
	Descrizione / Description Description / Beschreibung / Descripción		M³ Kg	Articolo Item / Article Artikel / Artículo	Prezzo Price / Prix Preis / Precio
	PIEDE in alluminio Aluminium foot Pied en aluminium Aluminiumfuß Pata de aluminio	DX / RH Droite / Rechts Dcho	- ----- 8	VPAD	€ 335,00
		SX / LH Gauche / Links Izq	- ----- 8	VPAS	€ 335,00
	MANIGLIA in alluminio per "Vela" Aluminium handle for "Vela" Poignée en aluminium pour "Vela" Griff aus Aluminium für "Vela" Tirador de aluminio para "Vela"	Interasse / Wheelbase Entraxe / Abstand Distancia entre ejes 352	- ----- 0,4	MA010	€ 31,00
	PIANO sagomato per servomobile Shaped top for movable unit Plan façonné pour module mobile Geformte Arbeitsplatte für Rollenschrank Encimera perfilada para módulo móvil	Stratificato Stratifié / Stratifié Schichtstoff Estratificado	- ----- 5,5	VPSS	€ 203,00
		Corian®	- ----- 6,2	VPSC	€ 238,00
		Vetro / Glass Verre / Glas / Vidrio	- ----- 10,8	VPSV	€ 334,00
		Extra-chiaro Extra clear Transparent Transparent Extra-claro			€ + 82,00
		Satinato / Satin Dépoli / Satiniert Satinado			€ + 88,00
	BORDO di finitura (ogni modulo) Finish profile (each unit) Bord de finissage (chaque module) Abschlussleiste (jedes Schrank) Borde de acabado (cada módulo)	Verniciato Painted / Verni Lackiert / Pintado	- ----- 0,7	BPV05	€ 25,00
		Stratificato Stratifié / Stratifié Schichtstoff Estratificado	- ----- -	BPS05	€ 112,00
		Corian®	- ----- -	BPC05	€ 154,00

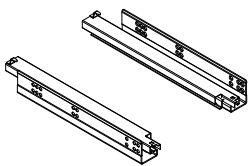
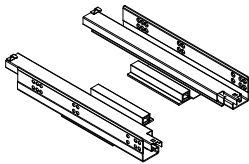
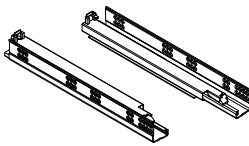
	Descrizione / Description Description / Beschreibung / Descripción	M³ Kg	Articolo Item / Article Artikel / Artículo	Prezzo Price / Prix Preis / Precio
	RUOTA senza freno (Tente) Castor without brake Roue sans frein Rad ohne Bremse Rueda sin freno	- 0,6	RUO32	€ 29,00
	RUOTA con freno (Tente) Castor with brake Roue avec frein Rad mit Bremse Rueda con freno	- 0,7	RUO33	€ 37,00
	COPPIA DI GUIDE con rientro ammortizzato per cassetto con maniglia Pair of guides with soft closing for drawer provided with handle Couple de glissières avec amortisseur pour tiroir avec poignée EIN PAAR Führungen mit Softeinzug für Schublade mit Griff Par de guías con cierre suave para cajón con tirador	- 1,7	GUI33	€ 60,00
	COPPIA DI GUIDE per cassetto Push-Pull Pair of guides for Push-Pull drawer Couple de glissières pour tiroir Push-Pull Eine Paar Führungen für Push-Pull Schublade Par de guías para cajón Push-Pull	- 1,9	GUI102	€ 77,00
	COPPIA DI GUIDE con rientro ammortizzato per cassetto Push-Pull Pair of guides with soft-close mechanism for Push-Pull drawer Paire de glissières avec retour amorti pour tiroir Push-Pull Paar Führungen mit gedämpfter Rückstellung für Push-Pull-Schubladen Par de guías con retorno amortiguado para cajón Push-Pull	- 1,9	GUI101	€ 152,00

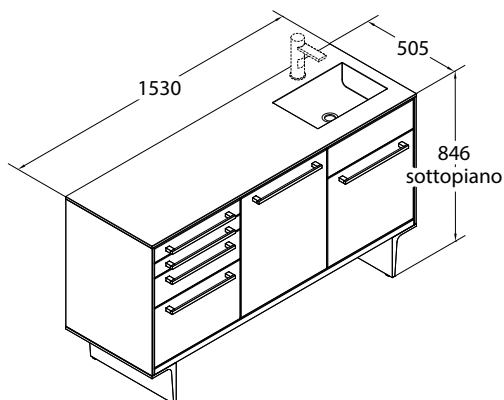

A

COMPOSIZIONE / COMPOSITION / COMPOSITION
ZUSAMMENSTELLUNG / COMPOSICIÓN

V4C + VPA + VLB

La composizione è comprensiva di bacinelle standard. Rubinetto escluso.

Trays included. Mixer excluded.
Intérieurs de tiroirs inclus. Robinet pas compris.
Standard Schubladeneinsätze sind enthalten. Armatur ist ausgeschlossen.
La composición incluye bandejas estándar.
Grifo excluido.

		Con piedi / On feet Sur pieds / Mit Füßen / Con patas		Sospesa / Suspended / Suspendue Wandhängend / Suspendida		
		Maniglia Handle / Poignée Griff / Tirador	Push-Pull	Maniglia Handle / Poignée Griff / Tirador	Push-Pull	
1	Piano in stratificato e fianchi verniciati Stratified top and painted sides / Plan stratifié et panneaux latéraux vernis / Arbeitsplatte aus Schichtstoff und lackierte Seitenwände / Encimera de estratificado y laterales pintados	+VFA	€ 4.607,00	€ 4.682,00	€ 4.006,00	€ 4.081,00
2	Piano in vetro e fianchi verniciati Glass top and painted sides / Plan en verre et côtés peints / Arbeitsplatte aus Glas und lackierte Seitenwände / Encimera de vidrio y laterales pintados	+VIV	€ 5.140,00	€ 5.214,00	€ 4.539,00	€ 4.614,00
3	Piano in Corian® e fianchi verniciati Corian® top and painted sides / Plan en Corian® et panneaux latéraux vernis / Arbeitsplatte aus Corian® und lackierte Seitenwände / Encimera de Corian® y laterales pintados	+VIC	€ 5.166,00	€ 5.241,00	€ 4.565,00	€ 4.640,00
4	Piano e fianchi in Corian® Corian® top and Corian® sides / Plan et panneau latéraux en Corian® / Arbeitsplatte und Seitenwände aus Corian® / Encimera y laterales de Corian®	+VIC	€ 7.070,00	€ 7.145,00	€ 6.467,00	€ 6.543,00

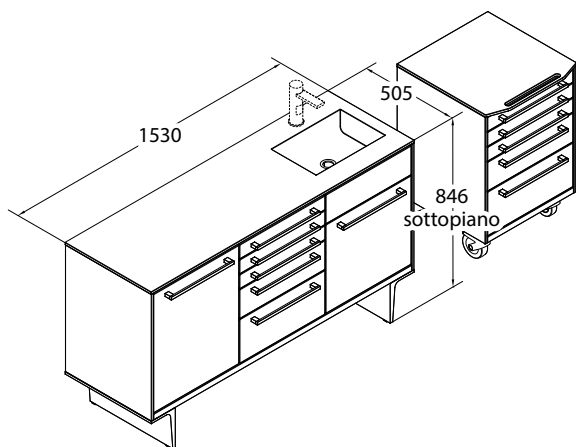

B

COMPOSIZIONE / COMPOSITION / COMPOSITION
ZUSAMMENSTELLUNG / COMPOSICIÓN

VPA + V5A + VLB + V5A + KR

La composizione è comprensiva di bacinelle standard. Rubinetto escluso.

Trays included. Mixer excluded.
Intérieurs de tiroirs inclus. Robinet pas compris.
Standard Schubladeneinsätze sind enthalten. Armatur ist ausgeschlossen.
La composición incluye bandejas estándar.
Grifo excluido.

		Con piedi / On feet Sur pieds / Mit Füßen / Con patas		Sospesa / Suspended / Suspendue Wandhängend / Suspendida		
		Maniglia Handle / Poignée Griff / Tirador	Push-Pull	Maniglia Handle / Poignée Griff / Tirador	Push-Pull	
1	Piano in stratificato e fianchi verniciati Stratified top and painted sides / Plan stratifié et panneaux latéraux vernis / Arbeitsplatte aus Schichtstoff und lackierte Seitenwände / Encimera de estratificado y laterales pintados	+VFA	€ 6.555,00	€ 6.825,00	€ 5.954,00	€ 6.224,00
2	Piano in vetro e fianchi verniciati Glass top and painted sides / Plan en verre et côtés peints / Arbeitsplatte aus Glas und lackierte Seitenwände / Encimera de vidrio y laterales pintados	+VIV	€ 7.237,00	€ 7.506,00	€ 6.636,00	€ 6.905,00
3	Piano in Corian® e fianchi verniciati Corian® top and painted sides / Plan en Corian® et panneaux latéraux vernis / Arbeitsplatte aus Corian® und lackierte Seitenwände / Encimera de Corian® y laterales pintados	+VIC	€ 7.149,00	€ 7.419,00	€ 6.548,00	€ 6.818,00
4	Piano e fianchi in Corian® Corian® top and Corian® sides / Plan et panneau latéraux en Corian® / Arbeitsplatte und Seitenwände aus Corian® / Encimera y laterales de Corian®	+VIC	€ 9.774,00	€ 10.043,00	€ 9.172,00	€ 9.441,00

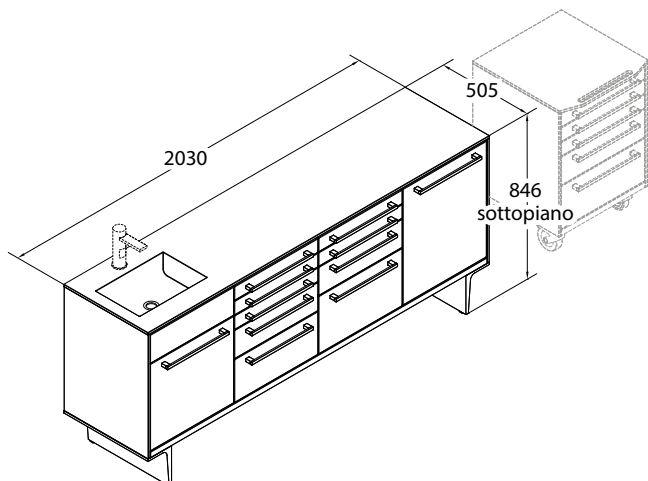

COMPOSIZIONE / COMPOSITION / COMPOSITION
ZUSAMMENSTELLUNG / COMPOSICIÓN

VLB + V5A + V4C + VPA

La composizione è comprensiva di bacinelle standard. Rubinetto escluso.

Trays included. Mixer excluded.
Intérieurs de tiroirs inclus. Robinet pas compris.
Standard Schubladeneinsätze sind enthalten. Armatur ist ausgeschlossen.
La composición incluye bandejas estándar. Grifo excluido.

		Con piedi / On feet Sur pieds / Mit Füßen / Con patas		Sospesa / Suspended / Suspendue Wandhängend / Suspendida		
		Maniglia Handle / Poignée Griff / Tirador	Push-Pull	Maniglia Handle / Poignée Griff / Tirador	Push-Pull	
1	Piano in stratificato e fianchi verniciati Stratified top and painted sides / Plan stratifié et panneaux latéraux vernis / Arbeitsplatte aus Schichtstoff und lackierte Seitenwände / Encimera de estratificado y laterales pintados	+VFA	€ 6.094,00	€ 6.331,00	€ 5.484,00	€ 5.721,00
2	Piano in vetro e fianchi verniciati Glass top and painted sides / Plan en verre et côtés peints / Arbeitsplatte aus Glas und lackierte Seitenwände / Encimera de vidrio y laterales pintados	+VIV	€ 6.640,00	€ 6.877,00	€ 6.030,00	€ 6.267,00
3	Piano in Corian® e fianchi verniciati Corian® top and painted sides / Plan en Corian® et panneaux latéraux vernis / Arbeitsplatte aus Corian® und lackierte Seitenwände / Encimera de Corian® y laterales pintados	+VIC	€ 6.718,00	€ 6.954,00	€ 6.108,00	€ 6.344,00
4	Piano e fianchi in Corian® Corian® top and Corian® sides / Plan et panneau latéraux en Corian® / Arbeitsplatte und Seitenwände aus Corian® / Encimera y laterales de Corian®	+VIC	€ 8.833,00	€ 9.069,00	€ 8.223,00	€ 8.459,00

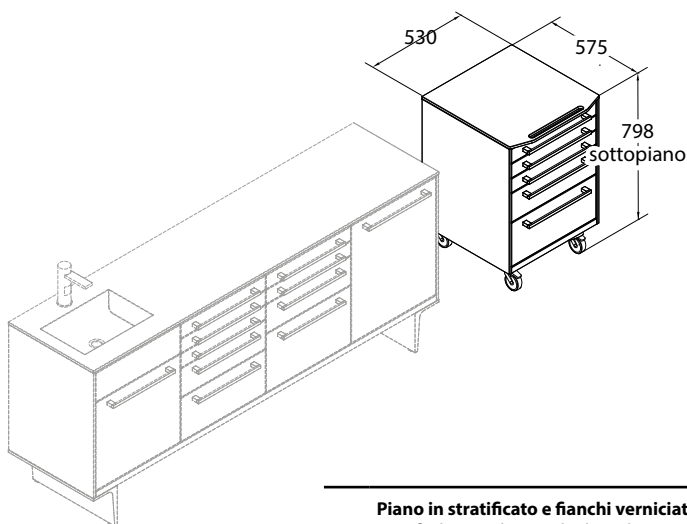

COMPOSIZIONE / COMPOSITION / COMPOSITION
ZUSAMMENSTELLUNG / COMPOSICIÓN

V5A + KR

La composizione è comprensiva di bacinelle standard.

Trays included.
Intérieurs de tiroirs inclus.
Standard Schubladeneinsätze sind enthalten.
La composición incluye bandejas estándar.

		Maniglia Handle / Poignée Griff / Tirador	Push-Pull
1	Piano in stratificato e fianchi verniciati Stratified top and painted sides / Plan stratifié et panneaux latéraux vernis / Arbeitsplatte aus Schichtstoff und lackierte Seitenwände / Encimera de estratificado y laterales pintados	€ 1.806,00	€ 1.968,00
2	Piano in vetro e fianchi verniciati Glass top and painted sides / Plan en verre et côtés peints / Arbeitsplatte aus Glas und lackierte Seitenwände / Encimera de vidrio y laterales pintados	€ 1.956,00	€ 2.118,00
3	Piano in Corian® e fianchi verniciati Corian® top and painted sides / Plan en Corian® et panneaux latéraux vernis / Arbeitsplatte aus Corian® und lackierte Seitenwände / Encimera de Corian® y laterales pintados	€ 1.841,00	€ 2.003,00
4	Piano e fianchi in Corian® Corian® top and Corian® sides / Plan et panneau latéraux en Corian® / Arbeitsplatte und Seitenwände aus Corian® / Encimera y laterales de Corian®	€ 2.562,00	€ 2.724,00

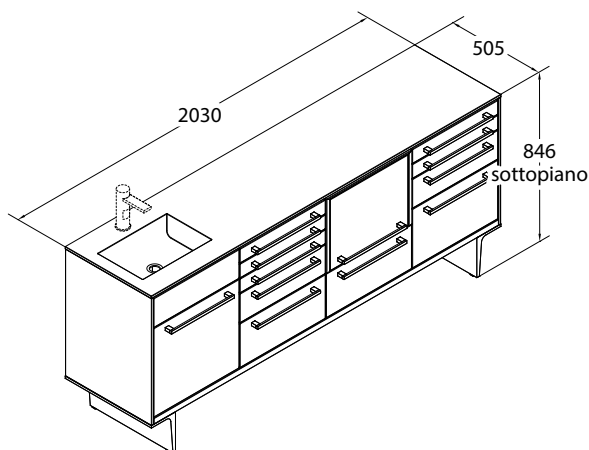

D

COMPOSIZIONE / COMPOSITION / COMPOSITION
ZUSAMMENSTELLUNG / COMPOSICIÓN

VLB + V5A + VRA + V4C

La composizione è comprensiva di bacinelle standard. Rubinetto escluso.

Trays included. Mixer excluded.
Intérieurs de tiroirs inclus. Robinet pas compris.
Standard Schubladeneinsätze sind enthalten. Armatur ist ausgeschlossen.
La composición incluye bandejas estándar.
Grifo excluido.

		Con piedi / On feet Sur pieds / Mit Füßen / Con patas		Sospesa / Suspended / Suspendue Wandhängend / Suspendida		
		Maniglia Handle / Poignée Griff / Tirador	Push-Pull	Maniglia Handle / Poignée Griff / Tirador	Push-Pull	
1	Piano in stratificato e fianchi verniciati Stratified top and painted sides / Plan stratifié et panneaux latéraux vernis / Arbeitsplatte aus Schichtstoff und lackierte Seitenwände / Encimera de estratificado y laterales pintados	+ VFA	€ 6.724,00	€ 7.077,00	€ 6.114,00	€ 6.467,00
2	Piano in vetro e fianchi verniciati Glass top and painted sides / Plan en verre et côtés peints / Arbeitsplatte aus Glas und lackierte Seitenwände / Encimera de vidrio y laterales pintados	+ VIV	€ 7.270,00	€ 7.622,00	€ 6.660,00	€ 7.012,00
3	Piano in Corian® e fianchi verniciati Corian® top and painted sides / Plan en Corian® et panneaux latéraux vernis / Arbeitsplatte aus Corian® und lackierte Seitenwände / Encimera de Corian® y laterales pintados	+ VIC	€ 7.347,00	€ 7.700,00	€ 6.737,00	€ 7.090,00
4	Piano e fianchi in Corian® Corian® top and Corian® sides / Plan et panneau latéraux en Corian® / Arbeitsplatte und Seitenwände aus Corian® / Encimera y laterales de Corian®	+ VIC	€ 9.462,00	€ 9.814,00	€ 8.852,00	€ 9.204,00

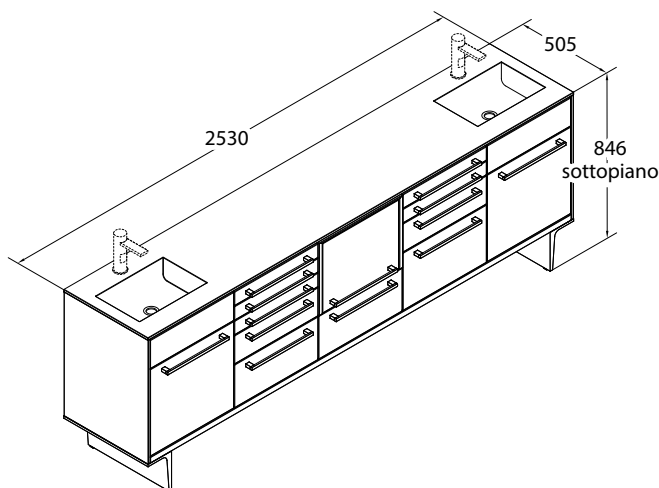

E

COMPOSIZIONE / COMPOSITION / COMPOSITION
ZUSAMMENSTELLUNG / COMPOSICIÓN

VLB + V5A + VRA + V4C + VLB

La composizione è comprensiva di bacinelle standard. Rubinetto escluso.

Trays included. Mixer excluded.
Intérieurs de tiroirs inclus. Robinet pas compris.
Standard Schubladeneinsätze sind enthalten. Armatur ist ausgeschlossen.
La composición incluye bandejas estándar.
Grifo excluido.

		Con piedi / On feet Sur pieds / Mit Füßen / Con patas		Sospesa / Suspended / Suspendue Wandhängend / Suspendida		
		Maniglia Handle / Poignée Griff / Tirador	Push-Pull	Maniglia Handle / Poignée Griff / Tirador	Push-Pull	
1	Piano in stratificato e fianchi verniciati Stratified top and painted sides / Plan stratifié et panneaux latéraux vernis / Arbeitsplatte aus Schichtstoff und lackierte Seitenwände / Encimera de estratificado y laterales pintados	+ VFA	€ 8.398,00	€ 8.716,00	€ 7.706,00	€ 8.024,00
2	Piano in vetro e fianchi verniciati Glass top and painted sides / Plan en verre et côtés peints / Arbeitsplatte aus Glas und lackierte Seitenwände / Encimera de vidrio y laterales pintados	+ VIV	€ 9.443,00	€ 9.760,00	€ 8.751,00	€ 9.068,00
3	Piano in Corian® e fianchi verniciati Corian® top and painted sides / Plan en Corian® et panneaux latéraux vernis / Arbeitsplatte aus Corian® und lackierte Seitenwände / Encimera de Corian® y laterales pintados	+ VIC	€ 9.445,00	€ 9.762,00	€ 8.753,00	€ 9.070,00
4	Piano e fianchi in Corian® Corian® top and Corian® sides / Plan et panneau latéraux en Corian® / Arbeitsplatte und Seitenwände aus Corian® / Encimera y laterales de Corian®	+ VIC	€ 11.769,00	€ 12.086,00	€ 11.079,00	€ 11.396,00

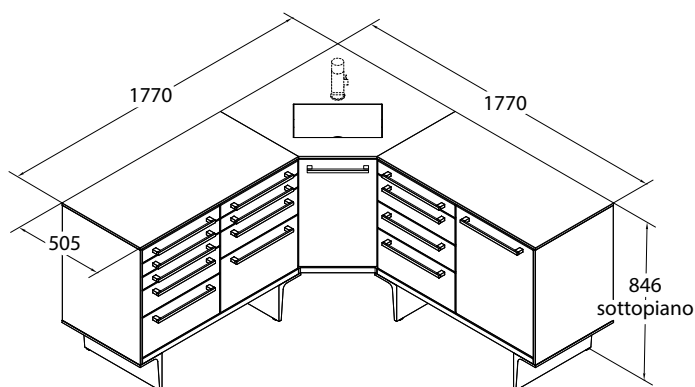

F

COMPOSIZIONE / COMPOSITION / COMPOSITION
ZUSAMMENSTELLUNG / COMPOSICIÓN

V5A + V4C + VAA + V4A + VPA

La composizione è comprensiva di bacinelle standard. Rubinetto escluso.

Trays included. Mixer excluded.
Intérieurs de tiroirs inclus. Robinet pas compris.
Standard Schubladeneinsätze sind enthalten. Armatur ist ausgeschlossen.
La composición incluye bandejas estándar.
Grifo excluido.

		Con piedi / On feet Sur pieds / Mit Füßen / Con patas		Sospesa / Suspended / Suspendue Wandhängend / Suspendida		
		Maniglia Handle / Poignée Griff / Tirador	Push-Pull	Maniglia Handle / Poignée Griff / Tirador	Push-Pull	
1	Piano in stratificato e fianchi verniciati Stratified top and painted sides / Plan stratifié et panneaux latéraux vernis / Arbeitsplatte aus Schichtstoff und lackierte Seitenwände / Encimera de estratificado y laterales pintados	+VFA	€ 8.562,00	€ 8.943,00	€ 7.446,00	€ 7.827,00
2	Piano in vetro e fianchi verniciati Glass top and painted sides / Plan en verre et côtés peints / Arbeitsplatte aus Glas und lackierte Seitenwände / Encimera de vidrio y laterales pintados	+VIV	€ 9.124,00	€ 9.505,00	€ 8.008,00	€ 8.389,00
3	Piano in Corian® e fianchi verniciati Corian® top and painted sides / Plan en Corian® et panneaux latéraux vernis / Arbeitsplatte aus Corian® und lackierte Seitenwände / Encimera de Corian® y laterales pintados	+VIC	€ 9.299,00	€ 9.679,00	€ 8.183,00	€ 8.563,00
4	Piano e fianchi in Corian® Corian® top and Corian® sides / Plan et panneau latéraux en Corian® / Arbeitsplatte und Seitenwände aus Corian® / Encimera y laterales de Corian®	+VIC	€ 12.403,00	€ 12.783,00	€ 11.145,00	€ 11.526,00

MODULI

Aggiungere ad ogni elemento il prezzo del supporto a pavimento o a muro, o del basamento e relativi fianchi laterali dove necessari, del piano, dell'alzatina, del lavello e del rubinetto.

(Il sottopiano è già incluso nei moduli).

I moduli su misura possono essere realizzati solo con anta: applicare il prezzo dell'articolo di misura superiore con un supplemento del 25%.

ATTENZIONE

Indicare sempre le misure delle apparecchiature che devono essere inserite nei moduli.

Le composizioni si intendono sempre a partire da sinistra verso destra. Specificare i colori di fianchi, frontali e sottopiano.

PER COLORI STANDARD SI INTENDE:

- Bianco Loran per i frontali, i fianchi di finitura e i basamenti
- Colori RAL per il sottopiano, ad eccezione dei Colori RAL metallizzati/perlati e brillanti

Specificare dimensioni e tipo di piano, alzatina, lavello e rubinetto.

Per composizioni con elementi ad angolo verificare la perpendicolarità delle pareti (90°): considerando la distanza di 80 cm su una parete e 60 cm sull'altra, la diagonale deve corrispondere a 100 cm.

Dimensioni: L = Larghezza P = Profondità H = Altezza

MANIGLIE ALLUMINIO

N.B.: solo in alluminio, **NO** verniciate.

SUPPORTI A PAVIMENTO

N.B.: In alluminio e verniciati.

CORIAN®, STRATIFICATO E LAMINATO FENIX®: solo di colore bianco.

MAGGIORAZIONI DI PREZZO PER COLORAZIONI SPECIALI

- RAL standard:

Supplemento coppia fianchi di finitura	+ 110,00 €
Supplemento serie frontali/anta (ogni mobile)	+ 110,00 €
Basamento (ogni mobile)	+ 40,00 €
- RAL metallizzati/perlati e brillanti e in altri colori diversi dalla cartella RAL:

Supplemento coppia fianchi di finitura	+ 220,00 €
Supplemento serie frontali/anta (ogni mobile)	+ 220,00 €
Basamento (ogni mobile)	+ 80,00 €
Sottopiano (ogni mobile)	+ 80,00 €

SPESE IMBALLO: ogni collo € 20,00 prezzo netto.

UNITS

Add the floor support, wall support or base and sides price, the top, splashback, sink and mixer prices to each unit.

(Undercounter included).

Made-to-measure units: apply the price of the article with the next greater size and add a 25% extra charge.

ATTENTION

Always provide the dimensions of the appliances that will be built into the units. The compositions are always understood as starting from the left to the right. Specify the colors of the lateral sides, fronts and undercounter.

STANDARD COLORS:

- Bianco Loran / White Loran for sides and fronts, sides and bases.
- RAL colors for the undercounter (NOT metallized/pearl and luminous RAL colors)

Specify the dimensions and type of top, splashback, sink and mixer.

Straight compositions with technical raceway and sink: use tops with minimum depth 520 mm.

For compositions with corner elements check that the walls are perfectly perpendicular (90°): considering the distance of 80 cm on the right and 60 cm left hand sides of the corner, the diagonal line must be 100 cm.

Dimensions: L = Width P = Depth H = Height

ALUMINIUM HANDLE

Attention: only aluminium, NOT painted.

FLOOR SUPPORT

Attention: Aluminium and painted.

CORIAN®, STRATIFIED and LAMINATE FENIX®: only in white color.

UPCHARGES FOR SPECIAL COLORS

- Standard RAL:

Sides (2x): upcharge	+ 110,00 €
Fronts/door: upcharge for each unit	+ 110,00 €
Base: upcharge for each unit	+40,00 €
- Metallized/pearl and luminous RAL colors and other different colors from the RAL colors:

Sides (2x): upcharge	+ 220,00 €
Fronts/door: upcharge for each unit	+ 220,00 €
Base: upcharge for each unit	+ 80,00 €
Undercounter: upcharge for each unit	+ 80,00 €

PACKING COSTS:

each package € 20,00 net price

MODULES

À chaque module il faut ajouter le prix de: support au sol, support au mur, base et cotés, plan, dossier, évier et robinet.

(Sous plan inclus).

Les modules sur mesure peuvent être réalisés uniquement avec une porte: appliquer le prix de l'article de mesure supérieure et ajouter un supplément de 25%.

ATTENTION

Indiquer obligatoirement les mesures exactes des appareils destinés à être introduits dans les meubles.

Les compositions s'entendent toujours en partant de gauche vers la droite.

Spécifier les couleurs des panneaux latéraux, façades et partie sous plan.

COULEURS STANDARD:

- Blanc Loran pour les côtés, les façades et les bases.
- Couleurs RAL pour le sous plan, sauf que les couleurs RAL métallisés/pearl et lumineux

Spécifier les dimensions et le type du plan, du dossier, du lavabo et du robinet.

Pour les compositions avec des éléments d'angle, contrôler soigneusement la perpendicularité des murs (90°): si on prend la distance exacte de 80 cm à droite et 60 cm à gauche de l'angle, la diagonale devra mesurer 100 cm.

Dimensions: L = Largeur P = Profondeur H = Hauteur

POIGNÉE EN ALUMINIUM

Attention: en aluminium, PAS peint.

SUPPORTS AU SOL

Attention: en aluminium et peint.

CORIAN®, STRATIFIE' et LAMINE' FENIX®: en couleur blanc seulement.

SUPPLÉMENTS DE PRIX POUR COULEURS SPÉCIALES

- **RAL standard:**
 - Côtés (2x): supplément de prix + 110,00 €
 - Façades/porte: supplément de prix pour chaque module + 110,00 €
 - Base: supplément de prix pour chaque module + 40,00 €
- **Couleurs RAL métallisés/pearl et lumineux et d'autres couleurs différentes des couleurs RAL:**
 - Côtés (2x): supplément de prix + 220,00 €
 - Façades/porte: supplément de prix pour chaque module + 220,00 €
 - Base: supplément de prix pour chaque module + 80,00 €
 - Sous plan: supplément de prix pour chaque module + 80,00 €

FRAIS D'EMBALLAGE:

prix net de chaque colis € 20,00

SCHRÄNKE

Bei jedem Element muss der Preis der Bodengestell, Wandbefestigung, Sockel und Seiten der Arbeitsplatte, der Aufkantung, der Spüle und der Wasserhahn separat berechnet werden.

(Unterbaus enthalten).

Maßgefertigte Schränke können nur mit Tür hergestellt werden: auf den Preis des nächst größeren Artikels einen Mehrpreis von 25% berechnen.

VORSICHT

Immer die Maße der Geräte angeben, die in die Schränke eingebaut werden.

Die Anbaulösungen sind immer von links nach rechts angegeben.

Die Farben der Seiten, der Fronten und des Unterbaus angeben.

STANDARD FARBEN:

- Loran Weiss für Seiten, Fronten und Sockel.
- RAL Farben für Unterbaus (keine Metallic/Perl und leuchtende RAL-Farben)

Abmessungen und Art der Arbeitsplatte, Aufkantung, Spüle und Wasserhahn angeben.

Bei Anbaulösungen mit Eckelementen auf lotrechte (90°) Wände achten: bei einem Abstand von 80 cm rechts und 60 cm links von der Ecke muss die Diagonale 100 cm betragen.

Abmessungen: L = Breite P = Tief H = Höhe

ALUMINIUMGRIFF

Bitte beachten: Aluminium, NICHT lackiert.

BODENGESTELL

Bitte beachten: Aluminium un lackiert.

CORIAN®, SCHICHTSTOFF und LAMINAT FENIX®: nur weiß.

AUFPREIS FÜR SONDERFARBEN

- **Standard RAL:**
 - Seiten (2x): Aufpreis + 110,00 €
 - Fronten/Tür: Aufpreis für jede Schrank + 110,00 €
 - Sockel: Aufpreis für jede Schrank + 40,00 €
- **Metallic/Perl und leuchtende RAL-Farben und anderen verschiedenen Farben der RAL-Farben:**
 - Seiten (2x): Aufpreis + 220,00 €
 - Fronten/Tür: Aufpreis für jede Schrank + 220,00 €
 - Sockel: Aufpreis für jede Schrank + 80,00 €
 - Unterbaus: Aufpreis für jede Schrank + 80,00 €

VERPACKUNGSKOSTEN:

jedes Paket € 20,00 Nettopreis

MÓDULOS

Añadir a cada elemento el precio del soporte de pie, del soporte en pared, de la base y de los paneles laterales, de la encimera, de la alzada, del lavabo y del grifo.

(Pieza debajo de la encimera incluida).

Los muebles a la medida pueden realizarse sólo con la puerta: aplicar el precio del artículo de medida superior con un recargo del 25%.

ATENCIÓN

Indicar siempre las medidas de los equipos que deben introducirse en los módulos.

Las composiciones se consideran siempre a partir de la izquierda hacia la derecha.

Especificar los colores de los paneles laterales, de los frentes y de la pieza debajo de la encimera.

COLORES ESTANDAR:

- Blanco Loran para los paneles laterales, los frentes y las bases.
- Colores RAL por la pieza debajo de la encimera, con la excepción de los colores RAL metalizados/perla y brillantes

Especificar las dimensiones y el tipo de encimera, de alzada, de lavabo y de grifo. Para composiciones con elementos en ángulo controlar la perpendicularidad de las paredes (90°): considerando la distancia de 80 cm a la dcha. y 60 cm a la izq.. del ángulo, la diagonal debe corresponder a 100 cm.

Dimensiones: L = Ancho P = Profundidad H = Alto

TIRADOR DE ALUMINIO

Atención: en aluminio, no pinta.

SOPORTE DE PIE

Atención: en aluminio y pinta.

CORIAN®, ESTRATIFICADO y LAMINADO FENIX®: de color blanco.

CARGOS ADICIONAL PARA COLORACIONES ESPECIALES

- **RAL estandar:**
 - Laterales (2x): cargo adicional + € 110,00
 - Frentes/puerta: cargo adicional por cada módulo + € 110,00
 - Base: cargo adicional por cada módulo + € 40,00
- **RAL metalizados/perla y brillantes y otros colores diferentes de colores RAL:**
 - Laterales (2x): cargo adicional + € 220,00
 - Frentes/puerta: cargo adicional por cada módulo + € 220,00
 - Base: cargo adicional por cada módulo + € 80,00
 - Pieza debajo de la encimera por cada módulo + € 80,00

EMBALAJE:

cada paquete € 20,00 precio neto

COLORI PER FRONTALI, FIANCHI E BASAMENTI A RICHIESTA / Colours for fronts, sides and bases on request / Couleurs pour façades, panneaux latéraux et bases sur demande / Farben für Fronten, Seiten und Sockel auf Anfrage / Colores de los frentes, los paneles laterales y las bases de pedido

Finiture verniciate / Painted finishes / Finitions peintes / Lackierten Ausführungen / Acabados pintados

***Nuovi colori Loran** / New Loran colors / Nouvelles couleurs Loran/ Neue Loran-Farben / Nuevos colores Loran

					
LINO	CUOIO	NEVE	CIELO	AGAVE	EUCALIPTO
					
BIANCO	RAL 1015	RAL 1018	RAL 1023	RAL 2001	RAL 2012
					
RAL3000	RAL 3004	RAL 3016	RAL 4002	RAL 4006	RAL 5000
					
RAL 5002	RAL 5010	RAL 5012	RAL 5014	RAL 5022	RAL 5024
					
RAL 6000	RAL 6019	RAL 6027	RAL 7016	RAL 7022	RAL 7038
					
RAL 7045	RAL 8019	RAL 9001	RAL 9002	RAL 9005	SILBER

***Colorazioni speciali con maggiorazione di prezzo** / Special colors with upcharge
Couleurs spéciales avec supplément de prix / Sonderfarben gegen einem Aufpreis
Coloraciones especiales disponibles por un cargo adicional

Questo campionario deve essere considerato solo come guida indicativa del colore e non può essere utilizzato come riferimento originale per la produzione e la valutazione di superfici colorate.

This sample should only be considered as an indicative colour guide and cannot be used as an original reference for the production and assessment of colored surfaces.























Ce nuancier ne sert qu'à donner une idée des différents coloris et ne doit en aucun cas être utilisé comme référence originale pour la production et l'évaluation des surfaces colorées.

Diese Farbmuster sind unverbindlich und können vom Original Farbton der hergestellten Oberflächen abweichen.

Esta muestra de colores debe considerarse sólo como una guía indicativa del color, y no puede utilizarse como referencia original para la producción y evaluación de las superficies pintadas.





COLORE SOTTOPIANO / Undercounter colors / Couleur sous plan / Farbe Unterbau / Color debajo de la encimera

Finiture verniciate / Painted finishes / Finitions peintes / Lackierten Ausführungen / Acabados pintados

			
BIANCO Loran	RAL 1018	RAL 1023	RAL 3016
			
RAL 4002	RAL 5000	RAL 5002	RAL 5010
			
RAL 5012	RAL 5014	RAL 5022	RAL 6000
			
RAL 6019	RAL 6027	RAL 7045	RAL 9005
			
SILVER Loran	RAL 9007	RAL 7006	
<hr/>			
			
APRICOT	602 PLA	C3526	

Colorazioni speciali con maggiorazione di prezzo / Special colors with upcharge / Couleurs spéciales avec supplément de prix / Sonderfarben gegen einem Aufpreis / Coloraciones especiales disponibles por un cargo adicional

COLORI PIANI IN VETRO / Colors of the glass tops / Couleurs des plans en verre / Farben der Glasarbeitsplatten / Colores de las encimeras de vidrio

			
TURCHESE	LIMONE	VERDE ACQUA	VERDE
			
CELESTE	BLU CINA	ROSSO GRANATA	ROSSO VENEZIANO

Vetro extra-chiaro / Extra clear glass / Verre transparent / Transparent Glas / Vidrio transparente

		
GIALLO	AZZURRO MEDITERRANEO	GLICINE
		
SALMONE	GIALLO NEVADA	BIANCO

Disponibile in tutti i colori RAL / Available in all RAL colors

Questo campionario deve essere considerato solo come guida indicativa del colore e non può essere utilizzato come riferimento originale per la produzione e la valutazione di superfici colorate.

This sample should only be considered as an indicative colour guide and cannot be used as an original reference for the production and assessment of colored surfaces.

Ce nuancier ne sert qu'à donner une idée des différents coloris et ne doit en aucun cas être utilisé comme référence originale pour la production et l'évaluation des surfaces colorées.

Diese Farbmuster sind unverbindlich und können vom Original Farbtönen der hergestellten Oberflächen abweichen.

Esta muestra de colores debe considerarse sólo como una guía indicativa del color, y no puede utilizarse como referencia original para la producción y evaluación de las superficies pintadas.

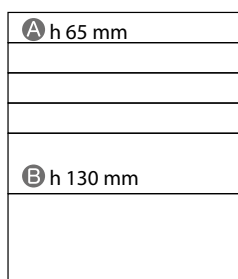
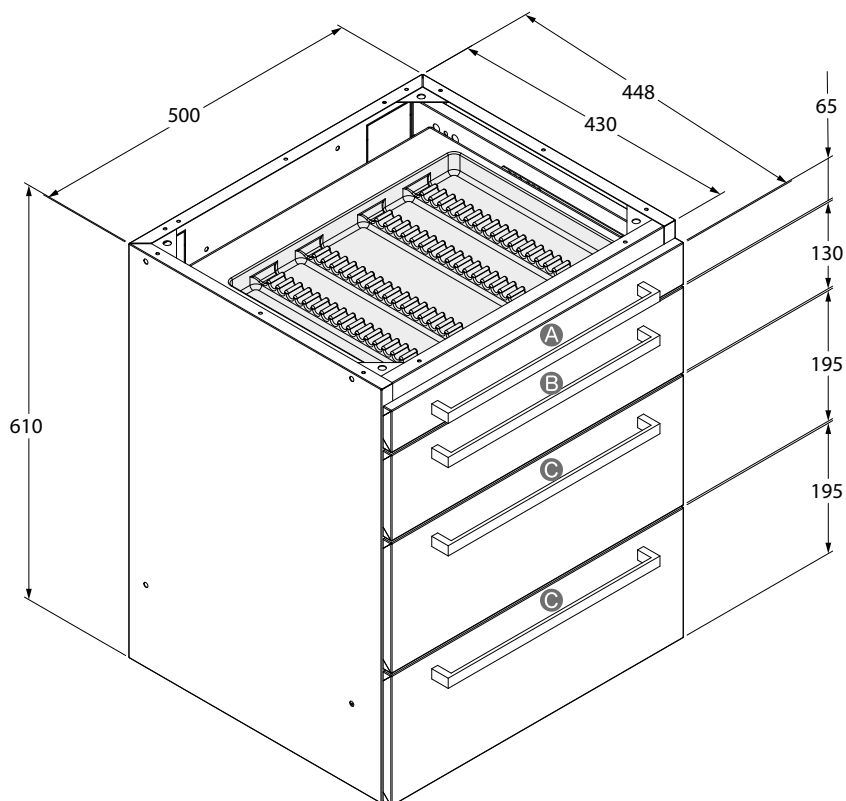

Cassetti
Drawers / Tiroirs
Schubladen / Cajones

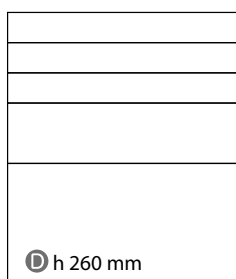

Cassetti
Drawers / Tiroirs
Schubladen / Cajones

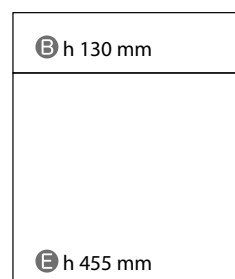

Cassetto + anta
Drawer + door / Tiroir +
porte / Schublade + Tür
Cajon + puerta

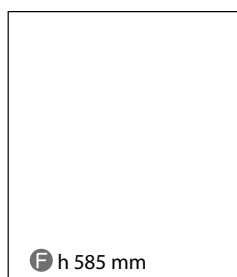

Anta / Sottolavello
Door / Sink unit
Porte / Module lavabo
Tür / Waschbeckenschrank
Puerta / Modulo bajo lavabo

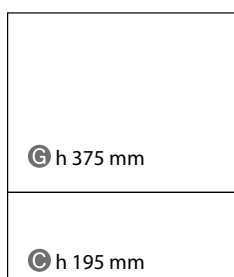

Anta a ribalta
Hide-away door
Porte basculante
Versenkbare Tür
Puerta escamoteable

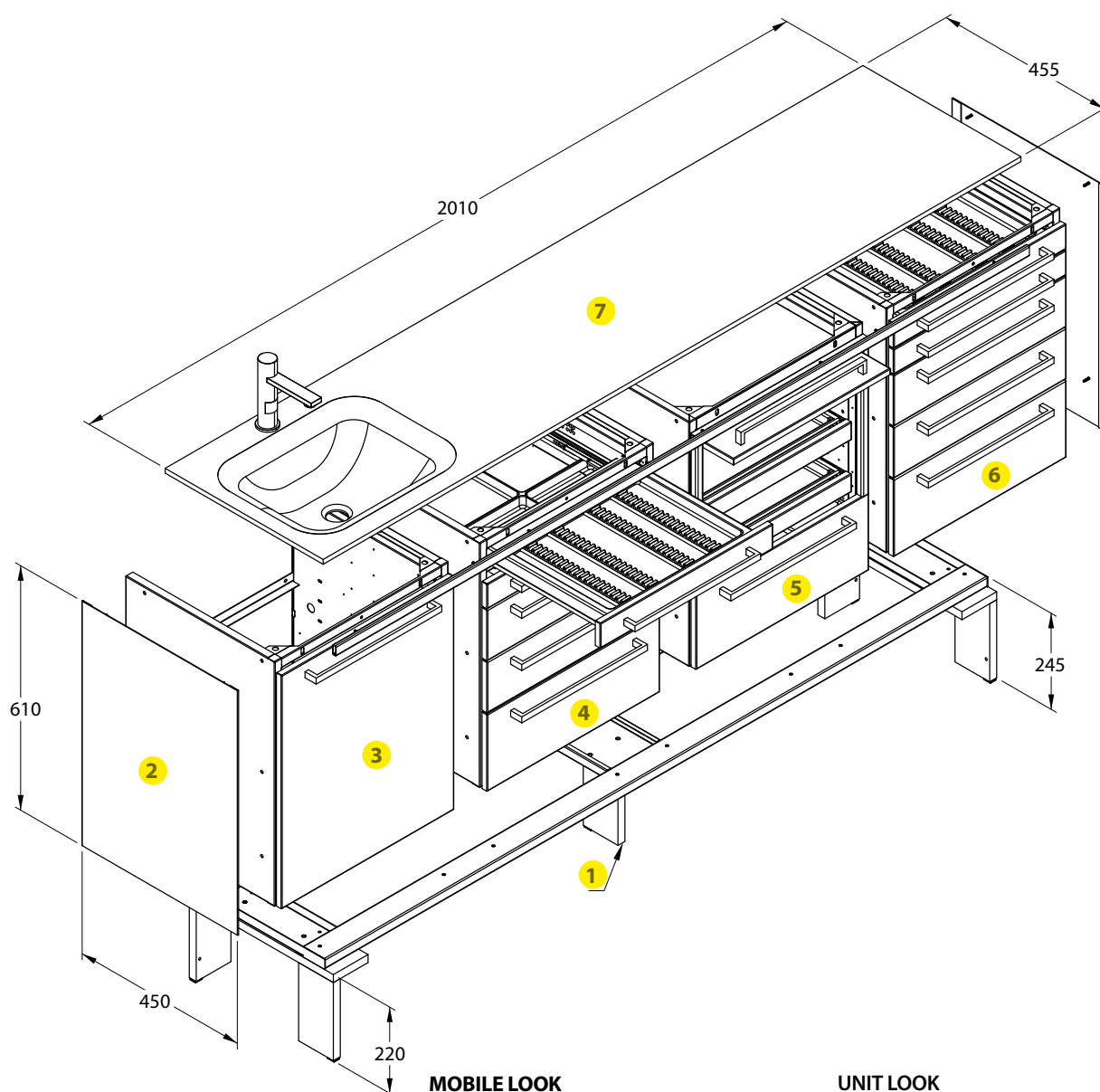

MOBILE LOOK

- 1 Supporto a pavimento
- 2 Fianco laterale
- 3 Mobile lavello
- 4 Mobile con 5 cassetti: 2 A, 2 B e 1 C
- 5 Mobile con anta a ribalta e due ripiani estraibili per apparecchiature
- 6 Mobile con 5 cassetti: 2 A, 2 B e 1 C
- 7 Piano con lavello sx

H Sottopiano 860 mm

MOBILIER LOOK

- 1 Support au sol
- 2 Panneau latéral
- 3 Module lavabo
- 4 Module avec 5 tiroirs: 2 A + 2 B + 1 C
- 5 Module avec porte basculante avec 2 tirettes pour appareils
- 6 Module avec 5 tiroirs: 2 A + 2 B + 1 C
- 7 Plan avec évier à gauche

H Sous plan de travail 860 mm

LOOK-MÖBEL

- 1 Bodengestell
- 2 Seitenwand
- 3 Waschbeckenschrank
- 4 Schrank mit 5 Schubladen: 2 A + 2 B + 1 C
- 5 Schrank mit versenkbarer Tür mit 2 Geräteeinlagen
- 6 Schrank mit 5 Schubladen: 2 A + 2 B + 1 C
- 7 Arbeitsplatte mit Waschbecken links

H Unter der Arbeitsplatte 860 mm

UNIT LOOK

- 1 Floor support
- 2 Lateral side
- 3 Sink unit
- 4 Unit with 5 drawers: 2 A, 2 B and 1 C
- 5 Unit with hide-away door equipped with 2 apparatus storage shelves
- 6 Unit with 5 drawers: 2 A, 2 B and 1 C
- 7 Top with sink on the left side

H Under the top 860 mm

MUEBLE LOOK

- 1 Soporte de pie
- 2 Panel lateral
- 3 Módulo bajo lavabo
- 4 Módulo con 5 cajones: 2 A + 2 B + 1 C
- 5 Módulo con puerta plegable con 2 estantes extraíbles para equipos y dos estantes interiores
- 6 Módulo con 5 cajones: 2 A + 2 B + 1 C
- 7 Encimera con lavabo izq.

A Bajo encimera 860 mm

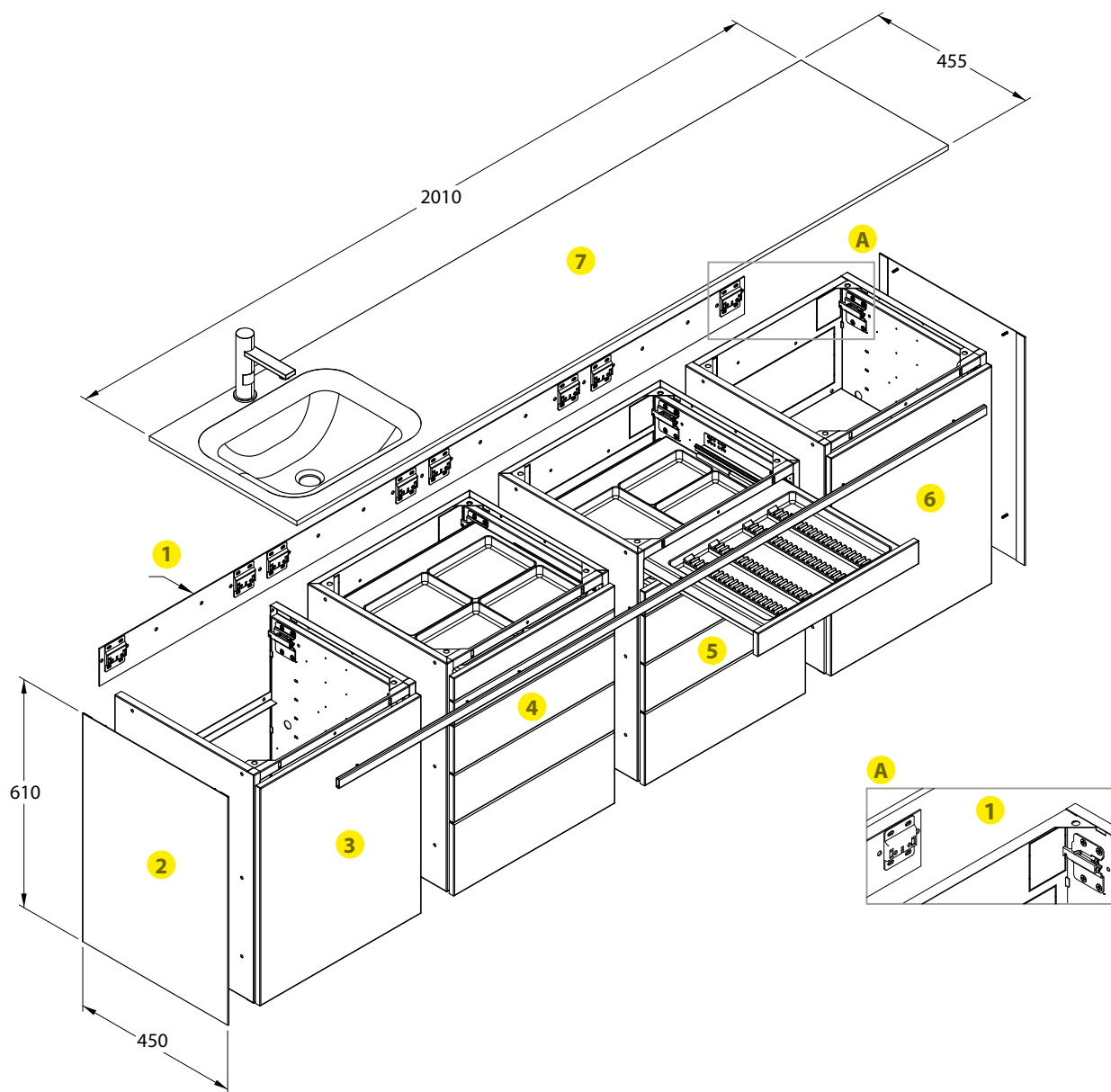

MOBILE LOOK

- 1 Sistema di aggancio per versione a muro
- 2 Fianco laterale
- 3 Mobile lavello
- 4 Mobile con 5 cassetti: 2 A, 2 B e 1 C
- 5 Mobile con 5 cassetti: 2 A, 2 B e 1 C
- 6 Mobile con anta e due ripiani interni
- 7 Piano con lavello sx

H Sottopiano 860 mm

MOBILIER LOOK

- 1 Système d'accrochage pour le support au mur
- 2 Panneau latéral
- 3 Module lavabo
- 4 Module avec 5 tiroirs: 2 A + 2 B + 1 C
- 5 Module avec 5 tiroirs: 2 A + 2 B + 1 C
- 6 Module avec porte et 2 étagères internes
- 7 Plan avec évier à gauche

H Sous plan de travail 860 mm

LOOK-MÖBEL

- 1 Kupplungssystem für die Wandbefestigung
- 2 Seitenwand
- 3 Waschbeckenschrank
- 4 Schrank mit 5 Schubladen: 2 A + 2 B + 1 C
- 5 Schrank mit 5 Schubladen: 2 A + 2 B + 1 C
- 6 Schrank mit Tür und 2 Einlegeböden
- 7 Arbeitsplatte mit Waschbecken links

H Unter der Arbeitsplatte 860 mm

UNIT LOOK

- 1 Coupling system for wall support
- 2 Lateral side
- 3 Sink unit
- 4 Unit with 5 drawers: 2 A, 2 B and 1 C
- 5 Unit with 5 drawers: 2 A, 2 B and 1 C
- 6 Unit with door and 2 interior shelves
- 7 Top with sink on the left side

H Under the top 860 mm

MUEBLE LOOK

- 1 Placa de soporte para el soporte en pared
- 2 Panel lateral
- 3 Módulo bajo lavabo
- 4 Módulo con 5 cajones: 2 A + 2 B + 1 C
- 5 Módulo con 5 cajones: 2 A + 2 B + 1 C
- 6 Módulo con puerta y dos estantes interiores
- 7 Encimera con lavabo izq.

A Bajo encimera 860 mm

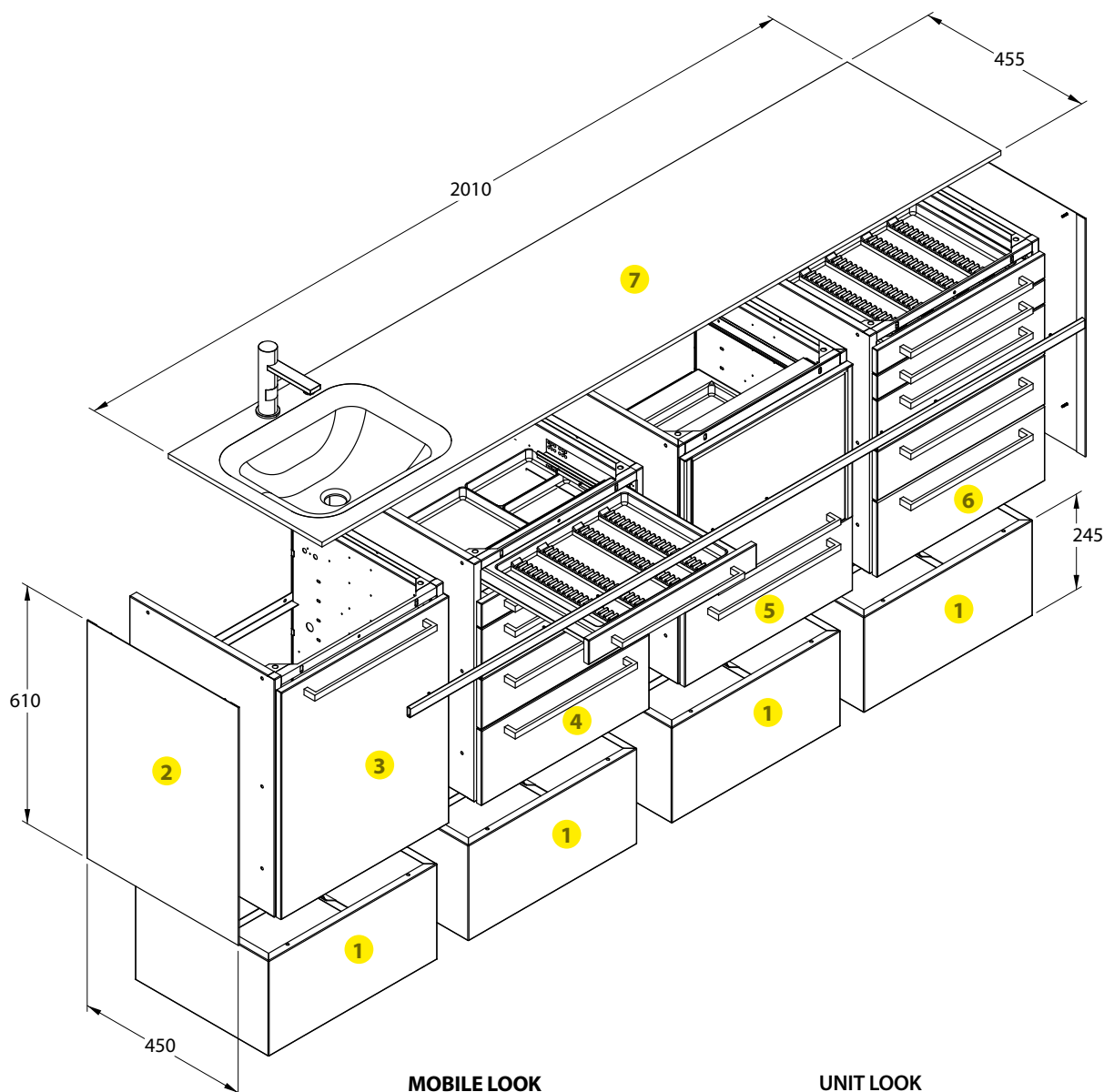

MOBILE LOOK

- 1 Basamento
- 2 Fianco laterale
- 3 Mobile lavello
- 4 Mobile con 5 cassetti: 2 A, 2 B e 1 C
- 5 Mobile con anta a ribalta e due ripiani estraibili per apparecchiature
- 6 Mobile con 5 cassetti: 2 A, 2 B e 1 C
- 7 Piano con lavello sx

H Sottopiano 860 mm

MOBILIER LOOK

- 1 Base
- 2 Panneau latéral
- 3 Module lavabo
- 4 Module avec 5 tiroirs: 2 A + 2 B + 1 C
- 5 Module avec porte basculante avec 2 tirettes pour appareils
- 6 Module avec 5 tiroirs: 2 A + 2 B + 1 C
- 7 Plan avec évier à gauche

H Sous plan de travail 860 mm

LOOK-MÖBEL

- 1 Sockel
- 2 Seitenwand
- 3 Waschbeckenschrank
- 4 Schrank mit 5 Schubladen: 2 A + 2 B + 1 C
- 5 Schrank mit versenkbarer Tür mit 2 Geräteeinlagen
- 6 Schrank mit 5 Schubladen: 2 A + 2 B + 1 C
- 7 Arbeitsplatte mit Waschbecken links

H Unter der Arbeitsplatte 860 mm

UNIT LOOK

- 1 Base unit
- 2 Lateral side
- 3 Sink unit
- 4 Unit with 5 drawers: 2 A, 2 B and 1 C
- 5 Unit with hide-away door equipped with 2 apparatus storage shelves
- 6 Unit with 5 drawers: 2 A, 2 B and 1 C
- 7 Top with sink on the left side

H Under the top 860 mm

MUEBLE LOOK

- 1 Base
- 2 Panel lateral
- 3 Módulo bajo lavabo
- 4 Módulo con 5 cajones: 2 A + 2 B + 1 C
- 5 Módulo con puerta plegable con 2 estantes extraíbles para equipos y dos estantes interiores
- 6 Módulo con 5 cajones: 2 A + 2 B + 1 C
- 7 Encimera con lavabo izq.

A Bajo encimera 860 mm

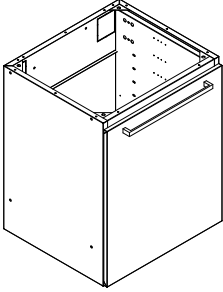
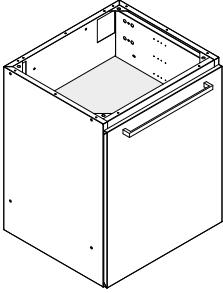
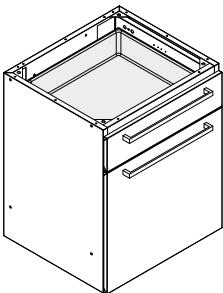
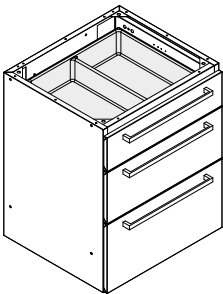
	Descrizione / Description Description / Beschreibung / Descripción	Apertura Opening / Ouverture Öffnung / Apertura	M ³ Kg	Articolo Item / Article Artikel / Artículo	Prezzo Price / Prix Preis / Precio
 <p>MODULO sottolavello con anta "LLA" o con cassettoni estraibile "LLC", con portarifiuti interno Sink unit with door "LLA" or pullout drawer "LLC", with rubbish bin Module lavabo avec porte "LLA" ou grand tiroir extractible "LLC", avec poubelle Waschbeckenschrank mit Tür "LLA" oder Schublade "LLC", mit Abfalleimer Módulo lavabo con puerta "LLA" o cajon "LLC", con cubo de basura</p> <p>L 500 x P 448 x H 610 mm</p>		Maniglia Handle Poignée Griff Tirador	0,25 24,2	LLAM	€ 488,00
		Push-Pull	0,25 24	LLAP	€ 513,00
			0,25 28,5	LLCP	€ 622,00
		 <p>MODULO con anta e due ripiani interni Unit with door and 2 interior shelves Module avec porte et 2 étagères internes Schrank mit Tür und 2 Einlegeböden Módulo con puerta y dos estantes interiores</p> <p>L 500 x P 448 x H 610 mm</p>		Maniglia Handle Poignée Griff Tirador	0,25 23
Push-Pull	0,25 22,8			LPAP	€ 480,00
 <p>MODULO con cassetto B e anta con 1 ripiano interno Unit with drawer B and door with an interior shelf Module avec 1 tiroir B et porte avec 1 étagère à l'intérieur Schrank mit 1 Schublade B und Tür mit 1 Einlegeboden Módulo con cajón B y puerta con 1 estante interior</p> <p>L 500 x P 448 x H 610 mm</p>		Maniglia Handle Poignée Griff Tirador	0,25 27,5	LPBM	€ 647,00
		Push-Pull	0,25 27,1	LPBP	€ 684,00
 <p>MODULO con 3 cassetti: 1 B, 1 C e 1 D Unit with 3 drawers: 1 B, 1 C and 1 D Module avec 3 tiroirs: 1 B, 1 C et 1 D Schrank mit 3 Schubladen: 1 B, 1 C und 1 D Módulo con 3 cajones: 1 B, 1 C y 1 D</p> <p>L 500 x P 448 x H 610 mm</p>		Maniglia Handle Poignée Griff Tirador	0,25 30,4	L3AM	€ 702,00
		Push-Pull	0,25 29,8	L3AP	€ 738,00

VELA
LOOK
LIKE
ALA/QUADRO NOVO/UPRIGHT
MOVINGTRAY MOVING ARM
PURA PURAstudio
STERIL K
CART
ARMADI
BACINELLE
PIANI ALZATINE
LAVELLI RUBINETTI
LAVORAZIONI ACCESSORI
OPEN BOX SEGGIOLINI
PROF
MAESTRO
IMPIANTISTICA

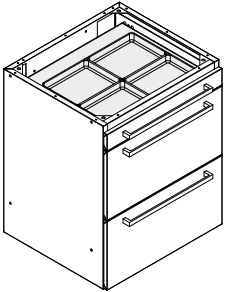
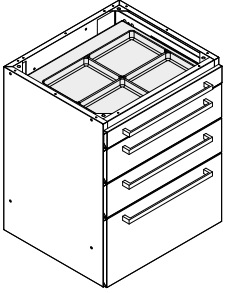
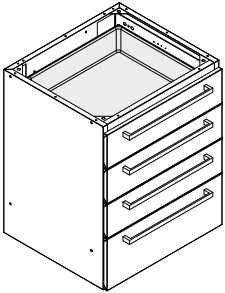
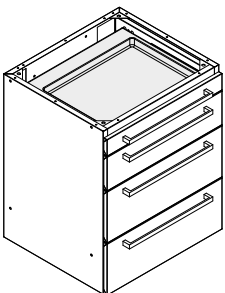
	Descrizione / Description Description / Beschreibung / Descripción	Apertura Opening / Ouverture Öffnung / Apertura	M ³ Kg	Articolo Item / Article Artikel / Artículo	Prezzo Price / Prix Preis / Precio
 <p>MODULO con 3 cassetti: 1 A e 2 D Unit with 3 drawers: 1 B and 2 D Module avec 3 tiroirs: 1 B et 2 D Schrank mit 3 Schubladen: 1 B und 2 D Módulo con 3 cajones: 1 B y 2 D</p> <p>Bacinelle / Trays / Intérieurs de tiroir / Einsätze / Bandejas: 1xLBA3, 2xLBC1</p> <p>L 500 x P 448 x H 610 mm</p>		Maniglia Handle Poignée Griff Tirador	0,25 30,2	L3BM	€ 726,00
		Push-Pull	0,25 29,6	L3BP	€ 763,00
 <p>MODULO con 4 cassetti: 1 A, 2 B e 1 D Unit with 4 drawers: 1 A, 2 B and 1 D Module avec 4 tiroirs: 1 A, 2 B et 1 D Schrank mit 4 Schubladen: 1 A, 2 B und 1 D Módulo con 4 cajones: 1 A, 2B y 1 D</p> <p>Bacinelle / Trays / Intérieurs de tiroir / Einsätze / Bandejas: 1xLBA3, 1xLBB1, 1xLBB2, 1xLBC1</p> <p>L 500 x P 448 x H 610 mm</p>		Maniglia Handle Poignée Griff Tirador	0,25 33,2	L4AM	€ 778,00
		Push-Pull	0,25 32,4	L4AP	€ 826,00
 <p>MODULO con 4 cassetti: 3 B e 1 C Unit with 4 drawers: 3 B and 1 C Module avec 4 tiroirs: 3 B et 1 C Schrank mit 4 Schubladen: 3 B und 1 C Módulo con 4 cajones: 3 B y 1 C</p> <p>Bacinelle / Trays / Intérieurs de tiroir / Einsätze / Bandejas: 1xLBB1, 1xLBB2, 1xLBB3, 1xLBC1</p> <p>L 500 x P 448 x H 610 mm</p>		Maniglia Handle Poignée Griff Tirador	0,25 33,4	L4BM	€ 778,00
		Push-Pull	0,25 32,6	L4BP	€ 826,00
 <p>MODULO con 4 cassetti: 1 A, 1 B e 2 C Unit with 4 drawers: 1 A, 1 B and 2 C Module avec 4 tiroirs: 1 A, 1 B et 2C Schrank mit 4 Schubladen: 1 A, 1 B und 2 C Módulo con 4 cajones: 1 A, 1 B y 2 C</p> <p>Bacinelle / Trays / Intérieurs de tiroir / Einsätze / Bandejas: 1xLBA2, 1xLBB3, 2xLBC1</p> <p>L 500 x P 448 x H 610 mm</p>		Maniglia Handle Poignée Griff Tirador	0,25 37,8	L4CM	€ 787,00
		Push-Pull	0,25 36,8	L4CP	€ 835,00

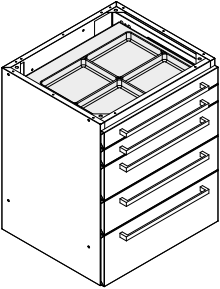
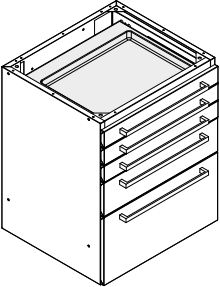
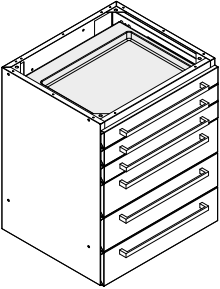
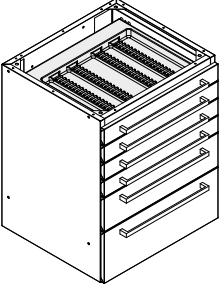
	Descrizione / Description Description / Beschreibung / Descripción	Apertura Opening / Ouverture Öffnung / Apertura	M ³ Kg	Articolo Item / Article Artikel / Artículo	Prezzo Price / Prix Preis / Precio
 <p>MODULO con 5 cassetti: 2 A, 2 B e 1 C Unit with 5 drawers: 2 A, 2 B and 1 C Module avec 5 tiroirs: 2 A, 2 B et 1 C Schrank mit 5 Schubladen: 2 A, 2 B und 1 C Módulo con 5 cajones: 2 A, 2 B y 1 C</p> <p>Bacinelle / Trays / Intérieurs de tiroir Einsätze / Bandejas: 1xLBA3, 1xLBA4, 1xLBB1, 1xLBB2, 1xLBC1</p> <p>L 500 x P 448 x H 610 mm</p>	<p>Maniglia Handle Poignée Griff Tirador</p>	<p>0,25 36</p>	<p>L5AM</p>	<p>€ 863,00</p>	
					<p>Push-Pull</p>
 <p>MODULO con 5 cassetti: 3 A, 1 B e 1 D Unit with 5 drawers: 3 A, 1 B and 1 D Module avec 5 tiroirs: 3 A, 1 B et 1 D Schrank mit 5 Schubladen: 3 A, 1 B und 1 D Módulo con 5 cajones: 3 A, 1 B y 1 D</p> <p>Bacinelle / Trays / Intérieurs de tiroir Einsätze / Bandejas: 1xLBA2, 1xLBA3, 1xLBA4, 1xLBB3, 1xLBC1</p> <p>L 500 x P 448 x H 610 mm</p>	<p>Maniglia Handle Poignée Griff Tirador</p>	<p>0,25 35,8</p>	<p>L5BM</p>	<p>€ 863,00</p>	
					<p>Push-Pull</p>
 <p>MODULO con 6 cassetti: 3 A e 3 B Unit with 6 drawers: 3 A and 3 B Module avec 6 tiroirs: 3 A et 3 B Schrank mit 6 Schubladen: 3 A und 3 B Módulo con 6 cajones: 3 A y 3 B</p> <p>Bacinelle / Trays / Intérieurs de tiroir / Einsätze / Bandejas: 1xLBA2, 1xLBA3, 1xLBA4, 1xLBB1, 1xLBB2, 1xLBB4</p> <p>L 500 x P 448 x H 610 mm</p>	<p>Maniglia Handle Poignée Griff Tirador</p>	<p>0,25 38,8</p>	<p>L6AM</p>	<p>€ 940,00</p>	
					<p>Push-Pull</p>
 <p>MODULO con 6 cassetti: 4 A, 1 B e 1 C Unit with 6 drawers: 4 A, 1 B and 1 C Module avec 6 tiroirs: 4 A, 1 B et 1 C Schrank mit 6 Schubladen: 4 A, 1 B und 1 C Módulo con 6 cajones: 4 A, 1 B y 1 C</p> <p>Bacinelle / Trays / Intérieurs de tiroir / Einsätze / Bandejas: 1xLBA1, 1xLBA2, 1xLBA3, 1xLBA4, 1xLBB4, 1xLBC1</p> <p>L 500 x P 448 x H 610 mm</p>	<p>Maniglia Handle Poignée Griff Tirador</p>	<p>0,25 38,6</p>	<p>L6BM</p>	<p>€ 948,00</p>	
					<p>Push-Pull</p>

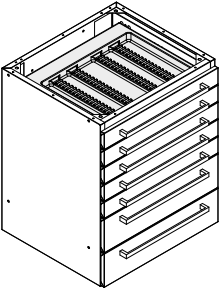
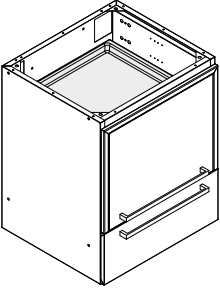
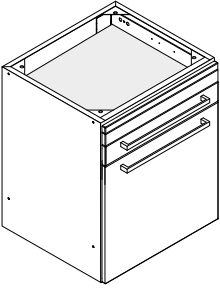
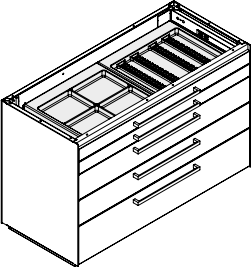
	Descrizione / Description Description / Beschreibung / Descripción	Apertura Opening / Ouverture Öffnung / Apertura	M ³ Kg	Articolo Item / Article Artikel / Artículo	Prezzo Price / Prix Preis / Precio
 <p>MODULO con 7 cassetti: 5 A e 2 B Unit with 7 drawers: 5 A and 2 B Module avec 7 tiroirs: 5 A et 2 B Schrank mit 7 Schubladen: 5 A et 2 B Módulo con 7 cajones: 5 A y 2 B</p> <p>Bacelle / Trays / Intérieurs de tiroir Einsätze / Bandejas: 1xLBA1, 2xLBA2, 1xLBA3, 1xLBA4, 1xLBB3, 1xLBB4</p> <p>L 500 x P 448 x H 610 mm</p>	<p>Maniglia Handle Poignée Griff Tirador</p>	0,25 41,4	L7AM	€ 1.024,00	
	<p>Push-Pull</p>	0,25 40	L7AP	€ 1.110,00	
 <p>MODULO con anta a ribalta con 2 ripiani estraibili per apparecchiature + ciabatta con 3 prese di corrente e cassetto C Unit with hide-away door equipped with 2 apparatus storage shelves + 3 Schuko sockets and 1 drawer C Module avec porte basculante avec 2 tirettes pour appareils + 3 prises de courant Schuko et 1 tiroir C Schrank mit versenkbarer Tür mit 2 Geräteeinlagen + 3 Schuko-Steckdosen und 1 Schublade C Módulo con puerta plegable con 2 estantes extraíbles para equipos + regleta con 3 tomas de corriente Schuko y cajón C</p> <p>Bacelle / Trays / Intérieurs de tiroir Einsätze / Bandejas: 1xLBC1</p> <p>L 500 x P 448 x H 610 mm</p>	<p>Maniglia Handle Poignée Griff Tirador</p>	0,25 30	LRAM	€ 1.051,00	
	<p>Push-Pull</p>	0,25 29,6	LRAP	€ 1.111,00	
 <p>MODULO PC con cassetto A per tastiera (L 385 - H 25 mm max), 1 cassetto A e anta, con schiena aperta Unit for PC with 1 drawer A for keyboard (L - H), 1 drawer A and door, open back Module pour PC avec 1 tiroir A pour clavier (L - H), 1 tiroir A et porte, ouvert derrière Schrank für PC mit 1 Schublade A für Tastatur (L - H), 1 Schublade A und Tür, Rückwand geöffnet Módulo PC con 1 cajón A porta teclado (L - H), 1 cajón A y puerta, con panel trasero abierto</p> <p>Bacelle / Trays / Intérieurs de tiroir Einsätze / Bandejas: 1xLBA2</p> <p>L 500 x P 448 x H 610 mm</p>	<p>Maniglia Handle Poignée Griff Tirador</p>	0,25 24	LPCM	€ 645,00	
	<p>Push-Pull</p>	0,25 23,6	LPCP	€ 682,00	
 <p>MODULO con 5 cassetti: 2 A, 2 B e 1 C Unit with 5 drawers: 2 A, 2 B and 1 C Module avec 5 tiroirs: 2 A, 2 B et 1 C Schrank mit 5 Schubladen: 2 A, 2 B und 1 C Módulo con 5 cajones: 2 A, 2 B y 1 C</p> <p>Bacelle / Trays / Intérieurs de tiroir Einsätze / Bandejas: 2xLBA3, 2xLBA4, 2xLBB1, 2xLBB2, 2xLBC1</p> <p>L 1000 x P 448 x H 610 mm</p>	<p>Maniglia Handle Poignée Griff Tirador</p>	0,55 61	L5AM2	€ 1.402,00	
	<p>Push-Pull</p>	0,55 60	L5AP2	€ 1.526,00	

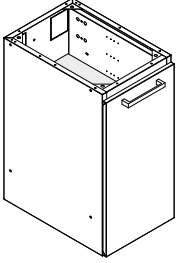
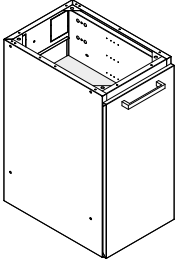
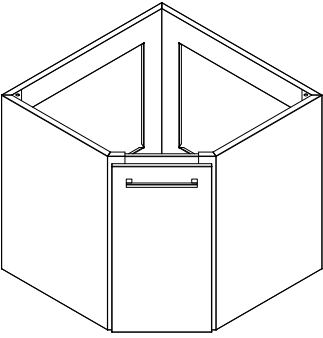
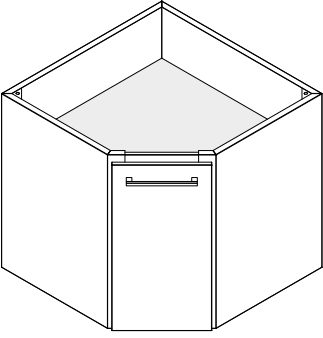
	Descrizione / Description Description / Beschreibung / Descripción	Apertura Opening / Ouverture Öffnung / Apertura	M ³ Kg	Articolo Item / Article Artikel / Artículo	Prezzo Price / Prix Preis / Precio
 <p>L 300/400 x P 448 x H 610 mm</p>	<p>MODULO con anta e due ripiani interni</p> <p>Unit with door and 2 interior shelves</p> <p>Module avec porte et 2 étagères internes</p> <p>Schrank mit Tür und 2 Einlegeböden</p> <p>Módulo con puerta y dos estantes interiores</p>	Maniglia Handle Poignée Griff Tirador	0,25 17	LPDM (L. 300 mm)	€ 456,00
			0,25 18	LPGM (L. 400 mm)	€ 456,00
		Push-Pull	0,25 16,9	LPDP (L. 300 mm)	€ 480,00
			0,25 17,9	LPGP (L. 400 mm)	€ 480,00
 <p>L 300 x P 448 x H 610 mm</p>	<p>MODULO con anta e due ripiani interni, con schiena aperta</p> <p>Unit with door and 2 interior shelves, open back</p> <p>Module avec porte et 2 étagères internes, ouvert derrière</p> <p>Schrank mit Tür und 2 Einlegeböden, Rückwand geöffnet</p> <p>Módulo con puerta y dos estantes interiores, con panel trasero abierto</p>	Maniglia Handle Poignée Griff Tirador	0,25 16,5	LPEM	€ 480,00
		Push-Pull	0,25 16,4	LPEP	€ 503,00
 <p>L 700 x P 700 x H 610 mm</p>	<p>MODULO angolare sottolavello con anta e portarifiuti interno</p> <p>Corner sink unit with door and rubbish bin</p> <p>Module lavabo d'angle avec porte et poubelle</p> <p>Eckwaschbeckenschrank mit Tür und Abfalleimer</p> <p>Módulo angular lavabo con puerta y cubo de basura</p>	Maniglia Handle Poignée Griff Tirador	0,50 19	LAAM	€ 653,00
		Push-Pull	0,50 18,8	LAAP	€ 678,00
 <p>L 700 x P 700 x H 610 mm</p>	<p>MODULO angolare con anta e 1 ripiano interno</p> <p>Corner unit with door and 1 interior shelf</p> <p>Module d'angle avec porte et 1 étagère interne</p> <p>Eckschrank mit Tür und 1 Einlegeboden</p> <p>Módulo angular con puerta y estante interior</p>	Maniglia Handle Poignée Griff Tirador	0,50 23,5	LACM	€ 653,00
		Push-Pull	0,50 23,3	LACP	€ 678,00

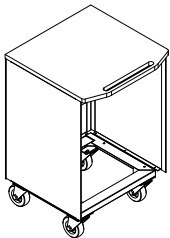
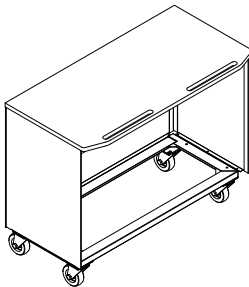
	Descrizione / Description Description / Beschreibung / Descripción	Piano Top / Plan Arbeitsplatte / Encimera	M ³ Kg	Articolo Item / Article Artikel / Artículo	Prezzo Price / Prix Preis / Precio
 <p>L 508 x P 500 x H 740 mm</p>	<p>Kit ruote + piano sagomato bianco Castor set + shaped top Kit roues + plan façonné Rollenset + geformtem Arbeitsplatte Kit de ruedas + encimera perfilada</p>	Corian®	0,08 24	KRLC	€ 516,00
		Stratificato Stratified / Stratifié Schichtstoff Estratificado	0,08 23,3	KRLS	€ 453,00
		Vetro Glass / Verre Glas / Vidrio	0,08 28,6	KRLV	€ 605,00
 <p>L 1008 x P 500 x H 740 mm</p>	<p>Kit ruote + piano sagomato bianco Castor set + shaped top Kit roues + plan façonné Rollenset + geformtem Arbeitsplatte Kit de ruedas + encimera perfilada</p>	Corian®	0,16 41	KRLC2	€ 834,00
		Stratificato Stratified / Stratifié Schichtstoff Estratificado	0,16 40	KRLS2	€ 770,00
		Vetro Glass / Verre Glas / Vidrio	0,16 49	KRLV2	€ 856,00
	<p>MAGGIORAZIONI per piano in vetro Additional charge for glass top Supplément de prix pour plan en verre Aufpreis für Glasarbeitsplatte Cargo adicional para encimera de vidrio</p>	Extra-chiaro Extra clear Transparent Transparente			€ + 82,00
		Satinato Satin / Dépoli Satinert Satinado			€ + 88,00

LOOK | Supporti a pavimento

Floor supports / Supports au sol / Bodengestelle / Soportes de pie

LORAN

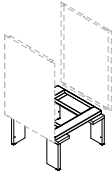
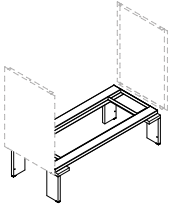
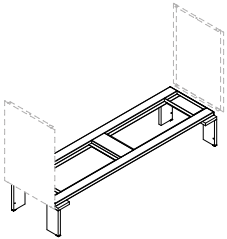
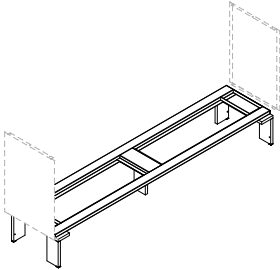
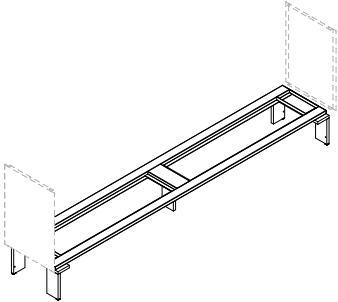
	Descrizione / Description Description / Beschreibung / Descripción	M ³ Kg	Articolo Item / Article Artikel / Artículo	Prezzo Price / Prix Preis / Precio
 <p>SUPPORTO a pavimento per 1 modulo lineare / Modulo angolare Floor support for 1 unit / Corner unit Support au sol pour 1 module / Module d'angle Bodengestell für 1 Schrank / Eckschrank Soporte de pie para 1 módulo / Módulo angular</p> <p>L 500 mm</p>		0,14 20	LS1V	€ 290,00
 <p>SUPPORTO a pavimento per 2 moduli Floor support for 2 units Support au sol pour 2 modules Bodengestell für 2 Schränke Soporte de pie para 2 módulos</p> <p>L 1000 mm</p>		0,26 23	LS2V	€ 339,00
 <p>SUPPORTO a pavimento per 3 moduli Floor support for 3 units Support au sol pour 3 modules Bodengestell für 3 Schränke Soporte de pie para 3 módulos</p> <p>L 1500 mm</p>		0,35 27	LS3V	€ 418,00
 <p>SUPPORTO a pavimento per 4 moduli Floor support for 4 units Support au sol pour 4 modules Bodengestell für 4 Schränke Soporte de pie para 4 módulos</p> <p>L 2000 mm</p>		0,50 32	LS4V	€ 603,00
 <p>SUPPORTO a pavimento per 5 moduli Floor support for 5 units Support au sol pour 5 modules Bodengestell für 5 Schränke Soporte de pie para 5 módulos</p> <p>L 2500 mm</p>		0,54 35	LS5V	€ 700,00

VELA

LOOK

LIKE

ALA / QUADRO
NOVO / UPRIGHTMOVINGTRAY
MOVING ARMPURA
PURASTUDIO

STERIL K

CART

ARMADI

BACINELLE

PIANI
ALZATINELAVELLI
RUBINETTILAVORAZIONI
ACCESSORIOPEN BOX
SEGGIOLINI

PROF

MAESTRO

IMPIANTISTICA

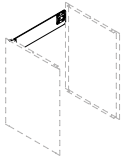
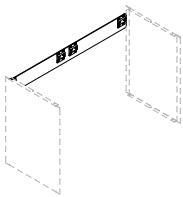
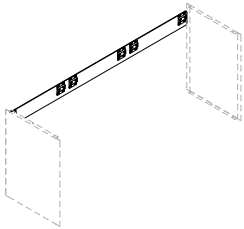
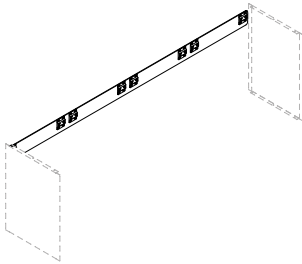
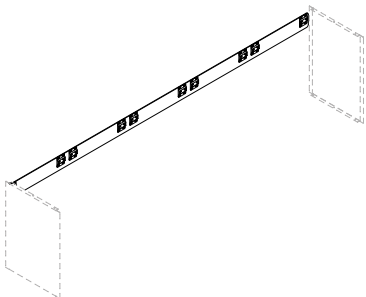
	Descrizione / Description Description / Beschreibung / Descripción	M ³ Kg	Articolo Item / Article Artikel / Artículo	Prezzo Price / Prix Preis / Precio
 L 500 mm	SUPPORTO a muro per 1 modulo / Angolare Wall support for 1 unit / Corner unit Support au mur pour 1 module / Module d'angle Wandbefestigung für 1 Schrank / Eckschrank Soporte de pared para 1 módulo / Módulo angular	0,01 2	LM1V	€ 121,00
 L 1000 mm	SUPPORTO a muro per 2 moduli Wall support for 2 units Support au mur pour 2 modules Wandbefestigung für 2 Schränke Soporte de pared para 2 módulos	0,02 3	LM2V	€ 140,00
 L 1500 mm	SUPPORTO a muro per 3 moduli Wall support for 3 units Support au mur pour 3 modules Wandbefestigung für 3 Schränke Soporte de pared para 3 módulos	0,03 6	LM3V	€ 158,00
 L 2000 mm	SUPPORTO a muro per 4 moduli Wall support for 4 units Support au mur pour 4 modules Wandbefestigung für 4 Schränke Soporte de pared para 4 módulos	0,04 7	LM4V	€ 203,00
 L 2500 mm	SUPPORTO a muro per 5 moduli Wall support for 5 units Support au mur pour 5 modules Wandbefestigung für 5 Schränke Soporte de pared para 5 módulos	0,05 9	LM5V	€ 219,00

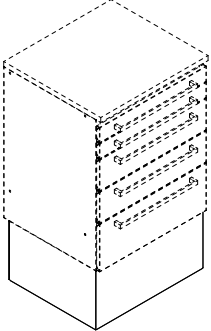
	Descrizione / Description Description / Beschreibung / Descripción	M ³ Kg	Articolo Item / Article Artikel / Artículo	Prezzo Price / Prix Preis / Precio
	L 685 x P 685 x H 245 mm Basamento angolare Corner base unit - Base d'angle Ecksockel - Base angular	- 6,5	LB01	€ 201,00
	L 300 x P 395 x H 245 mm Basamento / Base unit / Base Sockel / Base: L 300	- 3	LB02	€ 111,00
	L 400 x P 395 x H 245 mm Basamento / Base unit / Base Sockel / Base: L 400	- 4	LB06	€ 111,00
	L 500 x P 395 x H 245 mm Basamento / Base unit / Base Sockel / Base: L 500	- 5	LB03	€ 111,00
	L 1000 x P 395 x H 245 mm Basamento / Base unit / Base Sockel / Base: L 1000	- 9	LB05	€ 165,00

LOOK | Fianchi Sides / Côtés / Seiten / Laterales

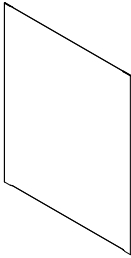
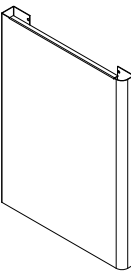
	Descrizione / Description Description / Beschreibung / Descripción	Fianchi Sides / Côtés Seiten / Laterales	M ³ Kg	Articolo Item / Article Artikel / Artículo	Prezzo Price / Prix Preis / Precio
	P 455 x H 610 mm SP 3 mm	FIANCO laterale Lateral side Panneau latéral Seitenwand Panel lateral	Verniciato Painted / Verni Lackiert / Pintado	- 3,8	LFV45 € 53,00
	P 505 x H 610 mm SP 3 mm		Verniciato Painted / Verni Lackiert / Pintado	- 4,2	LFV50 € 66,00
	P 600 x H 610 mm SP 3 mm		Verniciato Painted / Verni Lackiert / Pintado	- 5	LFV60 € 73,00
	P 450 x H 610 mm SP 46 mm	Fianco laterale Round Round lateral side Panneau latéral Round Round Seitenwand Panel lateral Round	Verniciato Painted / Verni Lackiert / Pintado	- 4,7	LFV45R € 184,00
	P 500 x H 610 mm SP 46 mm		Verniciato Painted / Verni Lackiert / Pintado	- 5,2	LFV50R € 184,00
	P 595 x H 610 mm SP 46 mm		Verniciato Painted / Verni Lackiert / Pintado	- 6,2	LFV60R € 184,00

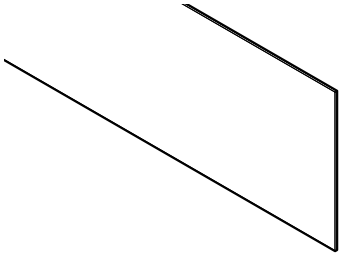
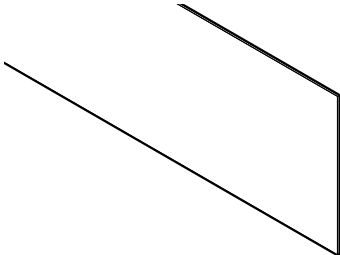
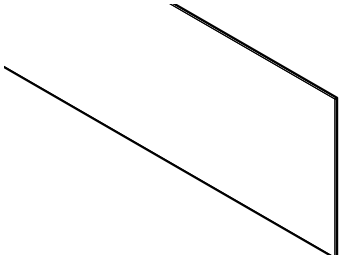
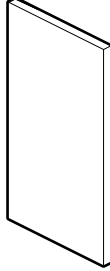
	Descrizione / Description Description / Beschreibung / Descripción	M ³ Kg	Articolo Item / Article Artikel / Artículo	Prezzo Price / Prix Preis / Precio
 <p>P 3 x H 610 mm</p>	<p>Tamponamento posteriore verniciato: al metro lineare</p> <p>Painted closing back panel: per meter Cache de fermeture à l'arrière, verni: au mètre Lackierte Verschlussverkleidung: je Meter Panel trasero, pintado: al m.</p>	- 5	LTV	€ 181,00
 <p>P 12 x H 610 mm</p>	<p>Tamponamento posteriore in stratificato: al metro lineare</p> <p>Stratified closing back panel: per meter Cache de fermeture à l'arrière, en stratifié: au mètre Verschlussverkleidung aus Schichtstoff: je Meter Panel trasero, de estratificado: al m.</p>	- 8	LTS	€ 543,00
 <p>P 12 x H 610 mm</p>	<p>Tamponamento posteriore in Corian®: al metro lineare</p> <p>Corian® closing back panel: per meter Cache de fermeture à l'arrière, en Corian®: au mètre Verschlussverkleidung aus Corian®: je Meter Panel trasero, de Corian®: al m.</p>	- 10	LTC	€ 711,00
 <p>L 25 x P 430 x H 860 mm</p>	<p>Pannello laterale verniciato di sostegno piano</p> <p>Painted top-support side panel Panneau latéral verni, de support pour le plan Lackierte Abschlussverkleidung Panel lateral pintado para el soporte de la encimera</p>	- 8	LSLS	€ 182,00

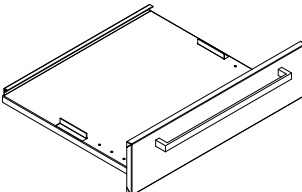
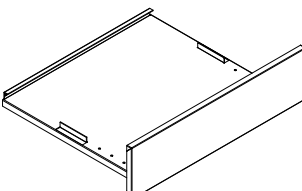
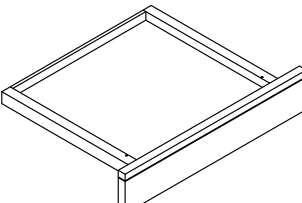
	Descrizione / Description Description / Beschreibung / Descripción	M³ Kg	Articolo Item / Article Artikel / Artículo	Prezzo Price / Prix Preis / Precio
 <p>CASSETTO con maniglia Drawer with handle Tiroir avec poignée Schublade mit Griff Cajón con tirador</p>	A) H 65	- 3,6	LCAAM	€ 141,00
	B) H 130	- 4,6	LCABM	€ 160,00
	C) H 195	- 5,4	LCACM	€ 190,00
	D) H 260	- 6,2	LCADM	€ 203,00
 <p>CASSETTO Push-Pull Drawer Push-Pull Tiroir Push-Pull Schublade Push-Pull Cajón Push-Pull</p>	A) H 65	- 3,4	LCAAP	€ 155,00
	B) H 130	- 4,4	LCABP	€ 173,00
	C) H 195	- 5,2	LCACP	€ 203,00
	D) H 260	- 6	LCADP	€ 215,00
 <p>CASSETTO per tastiera (L 385 - H 25 mm max) Drawer for keyboard (L 385 - H 30 mm) Tiroir pour clavier (L 385 - H 30 mm) Schublade für Tastatur (L 385 - H 30 mm) Cajón porta teclado (L 385 - H 30 mm)</p>	A) H 65	- 3,4	LCAAPK	€ 215,00

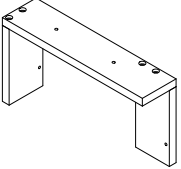
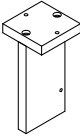
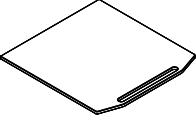
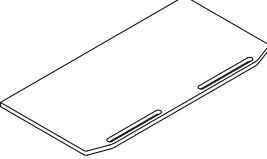
	Descrizione / Description Description / Beschreibung / Descripción		M³ Kg	Articolo Item / Article Artikel / Artículo	Prezzo Price / Prix Preis / Precio
	PIEDE in alluminio Aluminium foot Pied en aluminium Aluminiumfuß Pata de aluminio	DX / RH Droite / Rechts Dcho	- 4	LPAD	€ 137,00
		SX / LH Gauche / Links Izq	- 4	LPAS	€ 137,00
	PIEDE CENTRALE in alluminio Aluminium foot Pied en aluminium Aluminiumfuß Pata de aluminio		- 1,5	LPAC	€ 64,00
	PIANO sagomato per servomobile Shaped top for movable unit Plan façonné pour module mobile Geformte Arbeitsplatte für Rollenschrank Encimera perfilada para módulo móvil	Corian®	- 5,2	LPSC	€ 236,00
		Stratificato Stratified / Stratifié Schichtstoff Estratificado	- 4,5	LPSS	€ 201,00
		Vetro / Glass Verre / Glas / Vidrio	- 9	LPSV	€ 331,00
		Extra-chiaro Extra clear Transparent Transparent Extra-claro			€ +82,00
		Satinato / Satin Dépoli / Satiniert Satinado			€ +88,00
	PIANO sagomato per servomobile Shaped top for movable unit Plan façonné pour module mobile Geformte Arbeitsplatte für Rollenschrank Encimera perfilada para módulo móvil	Corian®	- 10,4	LPSC2	€ 471,00
		Stratificato Stratified / Stratifié Schichtstoff Estratificado	- 9	LPSS2	€ 400,00
		Vetro / Glass Verre / Glas / Vidrio	- 18	LPSV2	€ 518,00
		Extra-chiaro Extra clear Transparent Transparent Extra-claro			€ +82,00
		Satinato / Satin Dépoli / Satiniert Satinado			€ +88,00

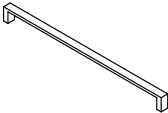
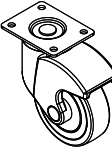
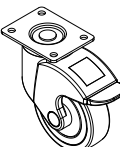
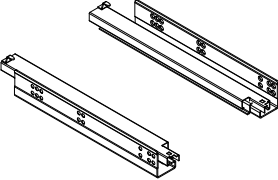
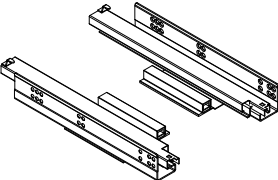
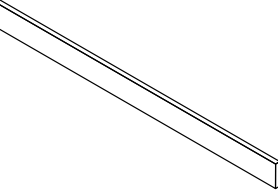
	Descrizione / Description Description / Beschreibung / Descripción	M ³ Kg	Articolo Item / Article Artikel / Artículo	Prezzo Price / Prix Preis / Precio
	MANIGLIA in alluminio per "Look" Aluminium handle for "Look" Poignée en aluminium pour "Look" Griff aus Aluminium für "Look" Tirador de aluminio para "Look"	Interasse / Wheelbase Entraxe / Abstand Distancia entre ejes 352	- 0,4	MA020 € 24,00
	RUOTA senza freno Castor without brake Roue sans frein Rad ohne Bremse Rueda sin freno	- 0,6	RUO26	€ 29,00
	RUOTA con freno Castor with brake Roue avec frein Rad mit Bremse Rueda con freno	- 0,7	RUO27	€ 37,00
	COPPIA DI GUIDE con rientro ammortizzato per cassetto con maniglia Pair of guides with soft closing for drawer provided with handle Couple de glissières avec amortisseur pour tiroir avec poignée EIN PAAR Führungen mit Softeinzug für Schublade mit Griff Par de guías con cierre suave para cajón con tirador	- 1,7	GUI55	€ 23,00
	COPPIA DI GUIDE per cassetto Push-Pull Pair of guides for Push-Pull drawer Couple de glissières pour tiroir Push-Pull Eine Paar Führungen für Push-Pull Schublade Par de guías para cajón Push-Pull	- 1,9	GUI56	€ 39,00
	Sottopiano "Look": al metro lineare Undercounter "Look": per meter Sous plan "Look": au mètre Unterbau "Look": je meter De Baio de la encimera "Look": al m.	- 1	LSPV	€ 27,00

L 1000 x P 10 x H 25 mm

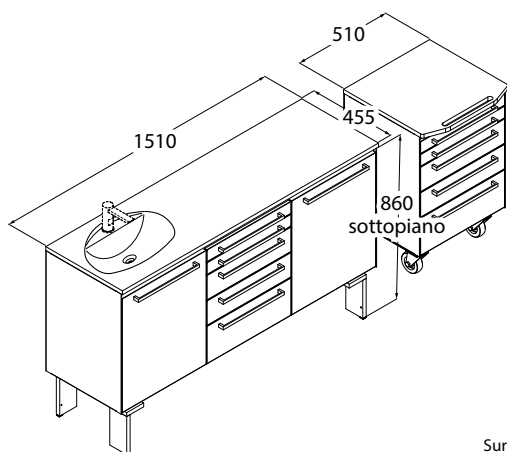

A

COMPOSIZIONE / COMPOSITION / COMPOSITION
ZUSAMMENSTELLUNG / COMPOSICIÓN

LLA + L5A + LPA + L5A + KR

La composizione è comprensiva di bacinelle standard.

Rubinetto escluso.

Trays included. Mixer excluded

Intérieurs de tiroirs inclus. Robinet pas compris.

Standard Schubladeneinsätze sind enthalten. Armatur ist ausgeschlossen.

La composición incluye bandejas estándar.

Grifo excluido.

	Con piedi / On feet Sur pieds / Mit Füßen / Con patas		Sospesa / Suspended / Suspendue Wandhängend / Suspendida		Basamento / Base units / Bases / Sockel / Bases	
	Maniglia Handle / Poignée Griff / Tirador	Push-Pull	Maniglia Handle / Poignée Griff / Tirador	Push-Pull	Maniglia Handle / Poignée Griff / Tirador	Push-Pull
1 Piano in laminato Fenix® "Fenix®" - laminate worktop / Plan de travail en laminé "Fenix®" / Arbeitsplatte aus Laminat "Fenix®" / Encimera de laminado "Fenix®" + VCF	€ 4.360,00	€ 4.532,00	€ 4.099,00	€ 4.272,00	€ 4.274,00	€ 4.446,00
2 Piano in stratificato Stratified top / Plan stratifié / Arbeitsplatte aus Schichtstoff / Encimera de estratificado + VCS	€ 4.851,00	€ 5.022,00	€ 4.591,00	€ 4.762,00	€ 4.766,00	€ 4.937,00
3 Piano in vetro Glass top / Plan en verre Arbeitsplatte aus Glas / Encimera de vidrio + VIV	€ 5.718,00	€ 5.890,00	€ 5.457,00	€ 5.630,00	€ 5.632,00	€ 5.804,00
4 Piano in Corian® Corian® top / Plan en Corian® Arbeitsplatte aus Corian® / Encimera de Corian® + VTC	€ 5.283,00	€ 5.455,00	€ 5.020,00	€ 5.195,00	€ 5.197,00	€ 5.370,00

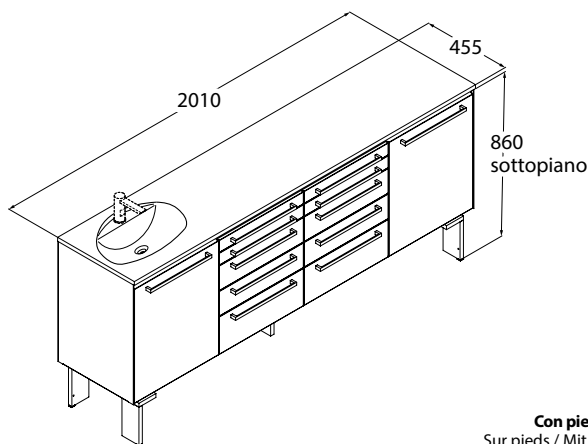

B

COMPOSIZIONE / COMPOSITION / COMPOSITION
ZUSAMMENSTELLUNG / COMPOSICIÓN

LLA + L5A + L5A + LPA

La composizione è comprensiva di bacinelle standard.

Rubinetto escluso.

Trays included. Mixer excluded

Intérieurs de tiroirs inclus. Robinet pas compris.

Standard Schubladeneinsätze sind enthalten. Armatur ist ausgeschlossen.

La composición incluye bandejas estándar.

Grifo excluido.

	Con piedi / On feet Sur pieds / Mit Füßen / Con patas		Sospesa / Suspended / Suspendue Wandhängend / Suspendida		Basamento / Base units / Bases / Sockel / Bases	
	Maniglia Handle / Poignée Griff / Tirador	Push-Pull	Maniglia Handle / Poignée Griff / Tirador	Push-Pull	Maniglia Handle / Poignée Griff / Tirador	Push-Pull
1 Piano in laminato Fenix® "Fenix®" - laminate worktop / Plan de travail en laminé "Fenix®" / Arbeitsplatte aus Laminat "Fenix®" / Encimera de laminado "Fenix®" + VCF	€ 4.193,00	€ 4.365,00	€ 3.793,00	€ 3.965,00	€ 4.033,00	€ 4.206,00
2 Piano in stratificato Stratified top / Plan stratifié / Arbeitsplatte aus Schichtstoff / Encimera de estratificado + VCS	€ 4.806,00	€ 4.977,00	€ 4.406,00	€ 4.577,00	€ 4.647,00	€ 4.818,00
3 Piano in vetro Glass top / Plan en verre Arbeitsplatte aus Glas / Encimera de vidrio + VIV	€ 5.539,00	€ 5.712,00	€ 5.139,00	€ 5.312,00	€ 5.379,00	€ 5.552,00
4 Piano in Corian® Corian® top / Plan en Corian® Arbeitsplatte aus Corian® / Encimera de Corian® + VTC	€ 5.241,00	€ 5.414,00	€ 4.841,00	€ 5.014,00	€ 5.082,00	€ 5.255,00

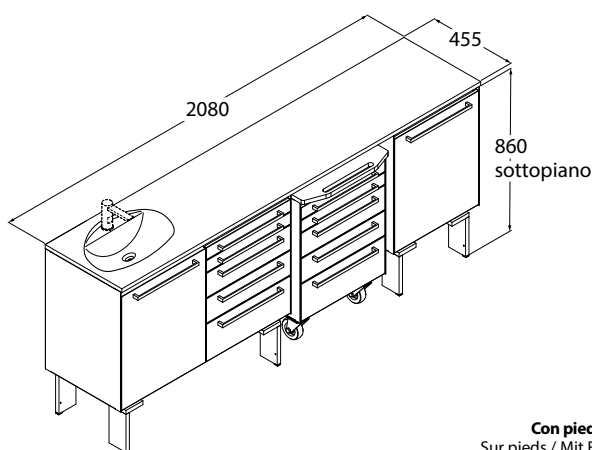

C

COMPOSIZIONE / COMPOSITION / COMPOSITION
ZUSAMMENSTELLUNG / COMPOSICIÓN

LLA + L5A + L5A + KR + LPA

La composizione è comprensiva di bacinelle standard. Rubinetto escluso.

Trays included. Mixer excluded.
Intérieurs de tiroirs inclus. Robinet pas compris.
Standard Schubladeneinsätze sind enthalten. Armatur ist ausgeschlossen.
La composición incluye bandejas estándar. Grifo excluido.

		Con piedi / On feet Sur pieds / Mit Füßen / Con patas		Sospesa / Suspended / Suspendue Wandhängend / Suspendida		Basamento / Base units / Bases / Sockel / Bases	
		Maniglia Handle / Poignée Griff / Tirador	Push-Pull	Maniglia Handle / Poignée Griff / Tirador	Push-Pull	Maniglia Handle / Poignée Griff / Tirador	Push-Pull
1	Piano in laminato Fenix® "Fenix®" - laminate worktop / Plan de travail en laminé "Fenix®" / Arbeitsplatte aus Laminat "Fenix®" / Encimera de laminado "Fenix®" + VCF	€ 4.794,00	€ 4.966,00	€ 4.426,00	€ 4.599,00	€ 4.496,00	€ 4.668,00
2	Piano in stratificato Stratified top / Plan stratifié / Arbeitsplatte aus Schichtstoff / Encimera de estratificado + VCS	€ 5.424,00	€ 5.595,00	€ 5.056,00	€ 5.227,00	€ 5.128,00	€ 5.299,00
3	Piano in vetro Glass top / Plan en verre Arbeitsplatte aus Glas / Encimera de vidrio + VIV	€ 6.309,00	€ 6.482,00	€ 5.942,00	€ 6.114,00	€ 6.012,00	€ 6.184,00
4	Piano in Corian® Corian® top / Plan en Corian® Arbeitsplatte aus Corian® / Encimera de Corian® + VTC	€ 5.932,00	€ 6.104,00	€ 5.563,00	€ 5.736,00	€ 5.633,00	€ 5.806,00

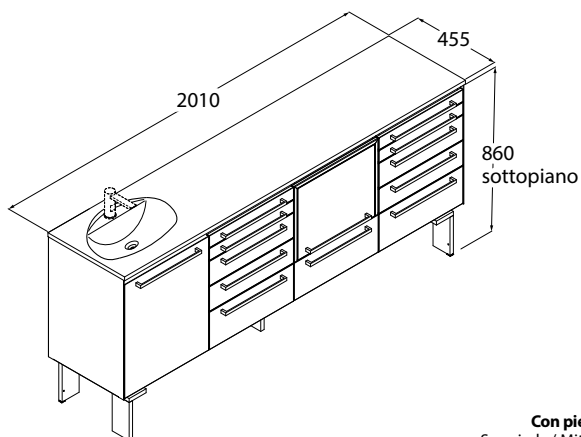

D

COMPOSIZIONE / COMPOSITION / COMPOSITION
ZUSAMMENSTELLUNG / COMPOSICIÓN

LLA + L5A + LRA + L5A

La composizione è comprensiva di bacinelle standard. Rubinetto escluso.

Trays included. Mixer excluded.
Intérieurs de tiroirs inclus. Robinet pas compris.
Standard Schubladeneinsätze sind enthalten. Armatur ist ausgeschlossen.
La composición incluye bandejas estándar. Grifo excluido.

		Con piedi / On feet Sur pieds / Mit Füßen / Con patas		Sospesa / Suspended / Suspendue Wandhängend / Suspendida		Basamento / Base units / Bases / Sockel / Bases	
		Maniglia Handle / Poignée Griff / Tirador	Push-Pull	Maniglia Handle / Poignée Griff / Tirador	Push-Pull	Maniglia Handle / Poignée Griff / Tirador	Push-Pull
1	Piano in laminato Fenix® "Fenix®" - laminate worktop / Plan de travail en laminé "Fenix®" / Arbeitsplatte aus Laminat "Fenix®" / Encimera de laminado "Fenix®" + VCF	€ 4.789,00	€ 4.997,00	€ 4.389,00	€ 4.597,00	€ 4.629,00	€ 4.837,00
2	Piano in stratificato Stratified top / Plan stratifié / Arbeitsplatte aus Schichtstoff / Encimera de estratificado + VCS	€ 5.401,00	€ 5.608,00	€ 5.001,00	€ 5.208,00	€ 5.242,00	€ 5.449,00
3	Piano in vetro Glass top / Plan en verre Arbeitsplatte aus Glas / Encimera de vidrio + VIV	€ 6.134,00	€ 6.342,00	€ 5.734,00	€ 5.942,00	€ 5.974,00	€ 6.182,00
4	Piano in Corian® Corian® top / Plan en Corian® Arbeitsplatte aus Corian® / Encimera de Corian® + VTC	€ 5.837,00	€ 6.045,00	€ 5.437,00	€ 5.645,00	€ 5.678,00	€ 5.886,00

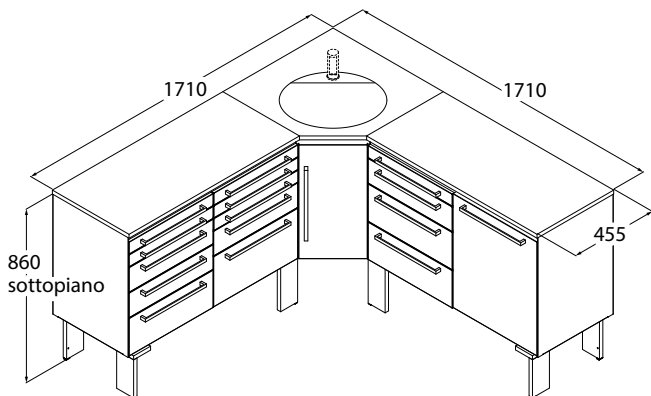

E

COMPOSIZIONE / COMPOSITION / COMPOSITION
ZUSAMMENSTELLUNG / COMPOSICIÓN

L5A + L5B + LAA + L4C + LPA

La composizione è comprensiva di bacinelle standard.

Rubinetto escluso.

Trays included. Mixer excluded.
Intérieurs de tiroirs inclus. Robinet pas compris.
Standard Schubladeneinsätze sind enthalten. Armatur ist ausgeschlossen.
La composición incluye bandejas estándar.
Grifo excluido.

	Con piedi / On feet Sur pieds / Mit Füßen / Con patas		Sospesa / Suspended / Suspendue Wandhängend / Suspendida		Basamento / Base units / Bases / Sockel / Bases	
	Maniglia Handle / Poignée Griff / Tirador	Push-Pull	Maniglia Handle / Poignée Griff / Tirador	Push-Pull	Maniglia Handle / Poignée Griff / Tirador	Push-Pull
1 Piano in laminato Fenix® "Fenix®" - laminate worktop / Plan de travail en laminé "Fenix®" / Arbeitsplatte aus Laminat "Fenix®" / Encimera de laminado "Fenix®" + VCF	€ 6.022,00	€ 6.242,00	€ 5.455,00	€ 5.675,00	€ 5.698,00	€ 5.918,00
2 Piano in stratificato Stratified top / Plan stratifié / Arbeitsplatte aus Schichtstoff / Encimera de estratificado + VCS	€ 6.656,00	€ 6.875,00	€ 6.089,00	€ 6.308,00	€ 6.333,00	€ 6.552,00
3 Piano in vetro Glass top / Plan en verre Arbeitsplatte aus Glas / Encimera de vidrio + VIV	€ 7.455,00	€ 7.675,00	€ 6.888,00	€ 7.108,00	€ 7.131,00	€ 7.351,00
4 Piano in Corian® Corian® top / Plan en Corian® Arbeitsplatte aus Corian® / Encimera de Corian® + VTC	€ 7.190,00	€ 7.410,00	€ 6.623,00	€ 6.843,00	€ 6.865,00	€ 7.086,00

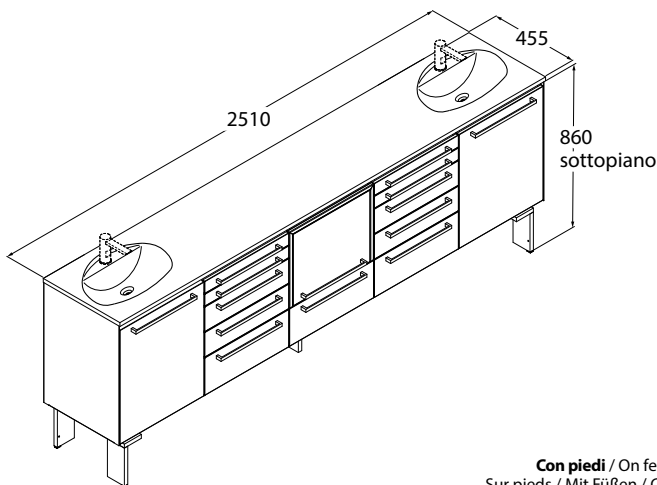

F

COMPOSIZIONE / COMPOSITION / COMPOSITION
ZUSAMMENSTELLUNG / COMPOSICIÓN

LLA + L5A + LRA + L5A + LLA

La composizione è comprensiva di bacinelle standard.

Rubinetto escluso.

Trays included. Mixer excluded.
Intérieurs de tiroirs inclus. Robinet pas compris.
Standard Schubladeneinsätze sind enthalten. Armatur ist ausgeschlossen.
La composición incluye bandejas estándar.
Grifo excluido.

	Con piedi / On feet Sur pieds / Mit Füßen / Con patas		Sospesa / Suspended / Suspendue Wandhängend / Suspendida		Basamento / Base units / Bases / Sockel / Bases	
	Maniglia Handle / Poignée Griff / Tirador	Push-Pull	Maniglia Handle / Poignée Griff / Tirador	Push-Pull	Maniglia Handle / Poignée Griff / Tirador	Push-Pull
1 Piano in laminato Fenix® "Fenix®" - laminate worktop / Plan de travail en laminé "Fenix®" / Arbeitsplatte aus Laminat "Fenix®" / Encimera de laminado "Fenix®" + VCF	€ 5.880,00	€ 6.113,00	€ 5.399,00	€ 5.633,00	€ 5.735,00	€ 5.968,00
2 Piano in stratificato Stratified top / Plan stratifié / Arbeitsplatte aus Schichtstoff / Encimera de estratificado + VCS	€ 6.739,00	€ 6.971,00	€ 6.258,00	€ 6.490,00	€ 6.594,00	€ 6.826,00
3 Piano in vetro Glass top / Plan en verre Arbeitsplatte aus Glas / Encimera de vidrio + VIV	€ 8.155,00	€ 8.388,00	€ 7.674,00	€ 7.907,00	€ 8.009,00	€ 8.243,00
4 Piano in Corian® Corian® top / Plan en Corian® Arbeitsplatte aus Corian® / Encimera de Corian® + VTC	€ 7.407,00	€ 7.641,00	€ 6.927,00	€ 7.160,00	€ 7.262,00	€ 7.495,00

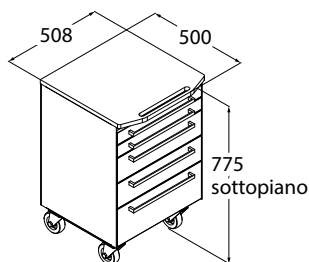

G

COMPOSIZIONE / COMPOSITION / COMPOSITION
ZUSAMMENSTELLUNG / COMPOSICIÓN

L5A + KR

La composizione è comprensiva di bacinelle standard.

Trays included.

Intérieurs de tiroirs inclus.

Standard Schubladeneinsätze sind enthalten.

La composición incluye bandejas estándar.

		Maniglia Handle / Poignée Griff / Tirador	Push-Pull
1	Piano in stratificato Stratified top / Plan stratifié / Arbeitsplatte aus Schichtstoff / Encimera de estratificado	€ 1.316,00	€ 1.378,00
2	Piano in vetro Glass top / Plan en verre Arbeitsplatte aus Glas / Encimera de vidrio	€ 1.468,00	€ 1.529,00
3	Piano in Corian® Corian® top / Plan en Corian® Arbeitsplatte aus Corian® / Encimera de Corian®	€ 1.379,00	€ 1.440,00

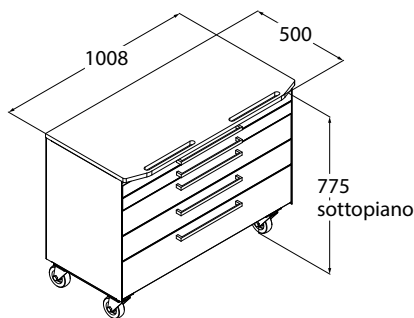

H

COMPOSIZIONE / COMPOSITION / COMPOSITION
ZUSAMMENSTELLUNG / COMPOSICIÓN

L5A_2 + KR

La composizione è comprensiva di bacinelle standard.

Trays included.

Intérieurs de tiroirs inclus.

Standard Schubladeneinsätze sind enthalten.

La composición incluye bandejas estándar.

		Maniglia Handle / Poignée Griff / Tirador	Push-Pull
1	Piano in stratificato Stratified top / Plan stratifié / Arbeitsplatte aus Schichtstoff / Encimera de estratificado	€ 2.172,00	€ 2.296,00
2	Piano in vetro Glass top / Plan en verre Arbeitsplatte aus Glas / Encimera de vidrio	€ 2.258,00	€ 2.383,00
3	Piano in Corian® Corian® top / Plan en Corian® Arbeitsplatte aus Corian® / Encimera de Corian®	€ 2.236,00	€ 2.360,00

MODULI

Aggiungere ad ogni elemento il prezzo del supporto a pavimento o del basamento e relativi fianchi laterali dove necessari, del piano, dell'alzatina, del lavello e del rubinetto.

(Il sottopiano è già incluso nei moduli).

I moduli su misura possono essere realizzati solo con anta: applicare il prezzo dell'articolo di misura superiore con un supplemento del 35%.

ATTENZIONE

Indicare sempre le misure delle apparecchiature che devono essere inserite nei moduli.

Le composizioni si intendono sempre a partire da sinistra verso destra.

Dimensioni: L = Larghezza P = Profondità H = Altezza

COLORI

Bianco Loran per i frontali, i fianchi di finitura, sottopiani e i basamenti.

Specificare dimensioni e tipo di piano, alzatina, lavello e rubinetto.

Per composizioni con elementi ad angolo verificare la perpendicolarità delle pareti (90°): considerando la distanza di 80 cm su una parete e 60 cm sull'altra, la diagonale deve corrispondere a 100 cm.

MANIGLIE ALLUMINIO

N.B.: solo in alluminio, **NO** verniciate.

SUPPORTI A PAVIMENTO

N.B.: solo verniciati Bianco Loran.

STRATIFICATO E LAMINATO

Solo di colore bianco.

SPESE IMBALLO

Ogni collo € 20,00 prezzo netto.

UNITS

Add the floor support or base and sides price, the top, splashback, sink and mixer prices to each unit.

(Undercounter included).

Made-to-measure units: apply the price of the article with the next greater size and add a 35% extra charge.

ATTENTION

Always provide the dimensions of the appliances that will be built into the units. The compositions are always understood as starting from the left to the right.

Dimensions:

L = Width P = Depth H = Height

COLORS

Bianco Loran / White Loran for sides and fronts, sides, undercounter and bases.

Specify the dimensions and type of top, splashback, sink and mixer.

For compositions with corner elements check that the walls are perfectly perpendicular (90°): considering the distance of 80 cm on the right and 60 cm left hand sides of the corner, the diagonal line must be 100 cm.

ALUMINIUM HANDLE

Attention: only aluminium, **NOT** painted.

FLOOR SUPPORT

Attention: only painted White Loran.

STRATIFIED and LAMINATE

only in white color.

PACKING COSTS

Each package € 20,00 net price.

MODULES

À chaque module il faut ajouter le prix de: support au sol, base et cotés, plan, dossier, évier et robinet.

(Sous plan inclus). Les modules sur mesure peuvent être réalisés uniquement avec une porte: appliquer le prix de l'article de mesure supérieure et ajouter un supplément de 35%.

ATTENTION

Indiquer obligatoirement les mesures exactes des appareils destinés à être introduits dans les meubles. Les compositions s'entendent toujours en partant de gauche vers la droite.

Dimensions:

L = Largeur P = Profondeur H = Hauteur

COULEURS

Blanc Loran pour les côtés, les façades, sous plan et les bases.

Spécifier les dimensions et le type de plan, du dossier, du lavabo et du robinet. Pour les compositions avec des éléments d'angle, contrôler soigneusement la perpendicularité des murs (90°): si on prend la distance exacte de 80 cm à droite et 60 cm à gauche de l'angle, la diagonale devra mesurer 100 cm

POIGNÉE EN ALUMINIUM

Attention: en aluminium, **PAS** peint.

SUPPORTS AU SOL

Attention: seulement peint Loran Blanc.

STRATIFIÉ et LAMINÉ

en couleur blanc seulement.

FRAIS D'EMBALLAGE

Prix net de chaque colis € 20,00.

SCHRÄNKE

Bei jedem Element muss der Preis der Bodengestell, Wandbefestigung, Sockel und Seiten der Arbeitsplatte, der Aufkantung, der Spüle und der Wasserhahn separat berechnet werden.

(Unterbaus enthalten).

Maßgefertigte Schränke können nur mit Tür hergestellt werden: auf den Preis des nächst größeren Artikels einen Mehrpreis von 35% berechnen.

VORSICHT

Immer die Maße der Geräte angeben, die in die Schränke eingebaut werden.

Die Anbaulösungen sind immer von links nach rechts angegeben.

Abmessungen:

L = Breite P = Tief H = Höhe

FARBEN

Loran Weiss für Seiten, Fronten, Unterbau und Sockel.

Abmessungen und Art der Arbeitsplatte, Aufkantung, Spüle und Wasserhahn angeben.

Bei Anbaulösungen mit Eckelementen auf lotrechte (90°) Wände achten: bei einem Abstand von 80 cm rechts und 60 cm links von der Ecke muss die Diagonale 100 cm betragen.

ALUMINIUMGRIFF

Bitte beachten: Aluminium, **NICHT** lackiert.

BODENGESTELL

Bitte beachten: nur gemalt Weißer Loran.

SCHICHTSTOFF und LAMINAT

Nur weiß.

VERPACKUNGSKOSTEN

Jedes Paket € 20,00 Nettopreis.

MÓDULOS

Añadir a cada elemento el precio del soporte en pared, de la base y de los paneles laterales, de la encimera, de la alzada, del lavabo y del grifo.

(Pieza debajo de la encimera incluida).

Los muebles a la medida pueden realizarse sólo con la puerta: aplicar el precio del artículo de medida superior con un recargo del 35%.

ATENCIÓN

Indicar siempre las medidas de los equipos que deben introducirse en los módulos.

Las composiciones se consideran siempre a partir de la izquierda hacia la derecha.

Dimensiones:

L = Ancho P = Profundidad H = Alto

COLORES ESTANDAR:

Blanco Loran para los paneles laterales, los frentes, de baio de la encimera y las bases.

Especificar las dimensiones y el tipo de encimera, de alzada, de lavabo y de grifo. Para composiciones con elementos en ángulo controlar la perpendicularidad de las paredes (90°): considerando la distancia de 80 cm a la dcha. y 60 cm a la izq.. del ángulo, la diagonal debe corresponder a 100 cm.

TIRADOR DE ALUMINIO

Atención: en aluminio, **NO** pintada.

SOPORTE DE PIE

Atención: solo pintado Loran blanco.

ESTRATIFICADO y LAMINADO

De color blanco.

EMBALAJE

Cada paquete € 20,00 precio neto.

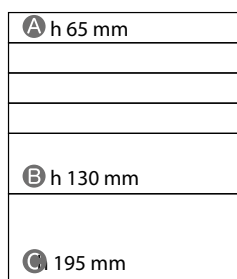
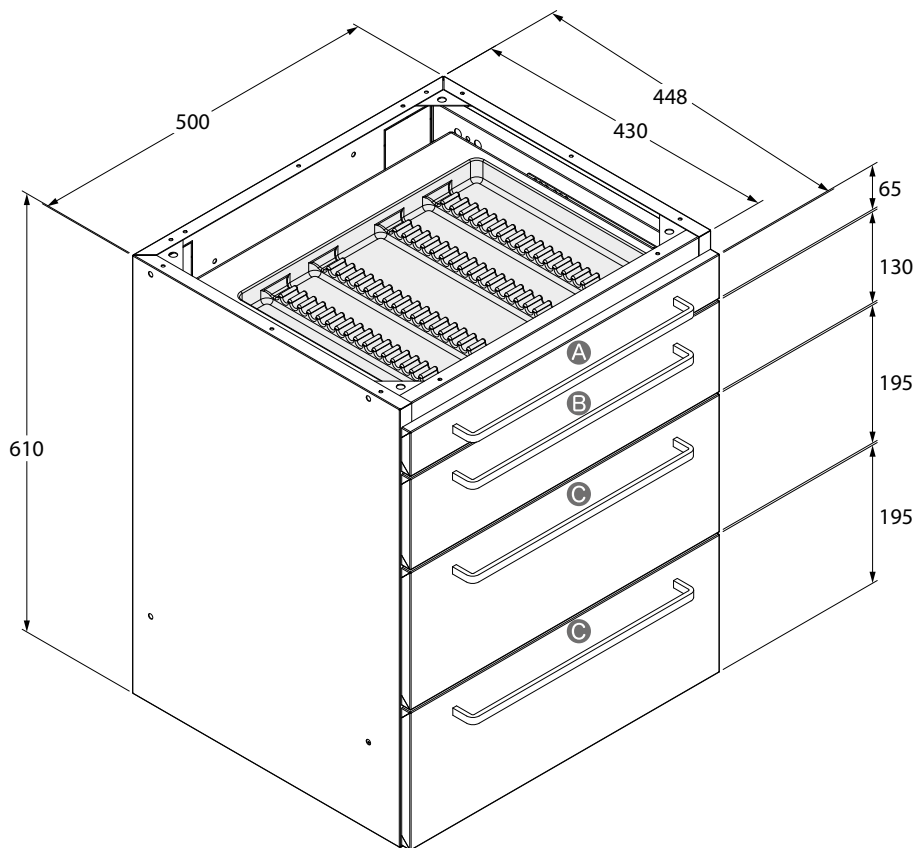

Cassetti
Drawers / Tiroirs
Schubladen / Cajones

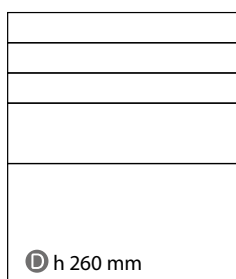

Cassetti
Drawers / Tiroirs
Schubladen / Cajones

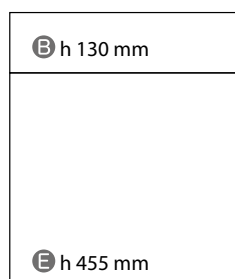

Cassetto + anta
Drawer + door / Tiroir +
porte / Schublade + Tür
Cajon + puerta



Anta / Sottolavello
Door / Sink unit
Porte / Module lavabo
Tür / Waschbeckenschrank
Puerta / Modulo bajo lavabo

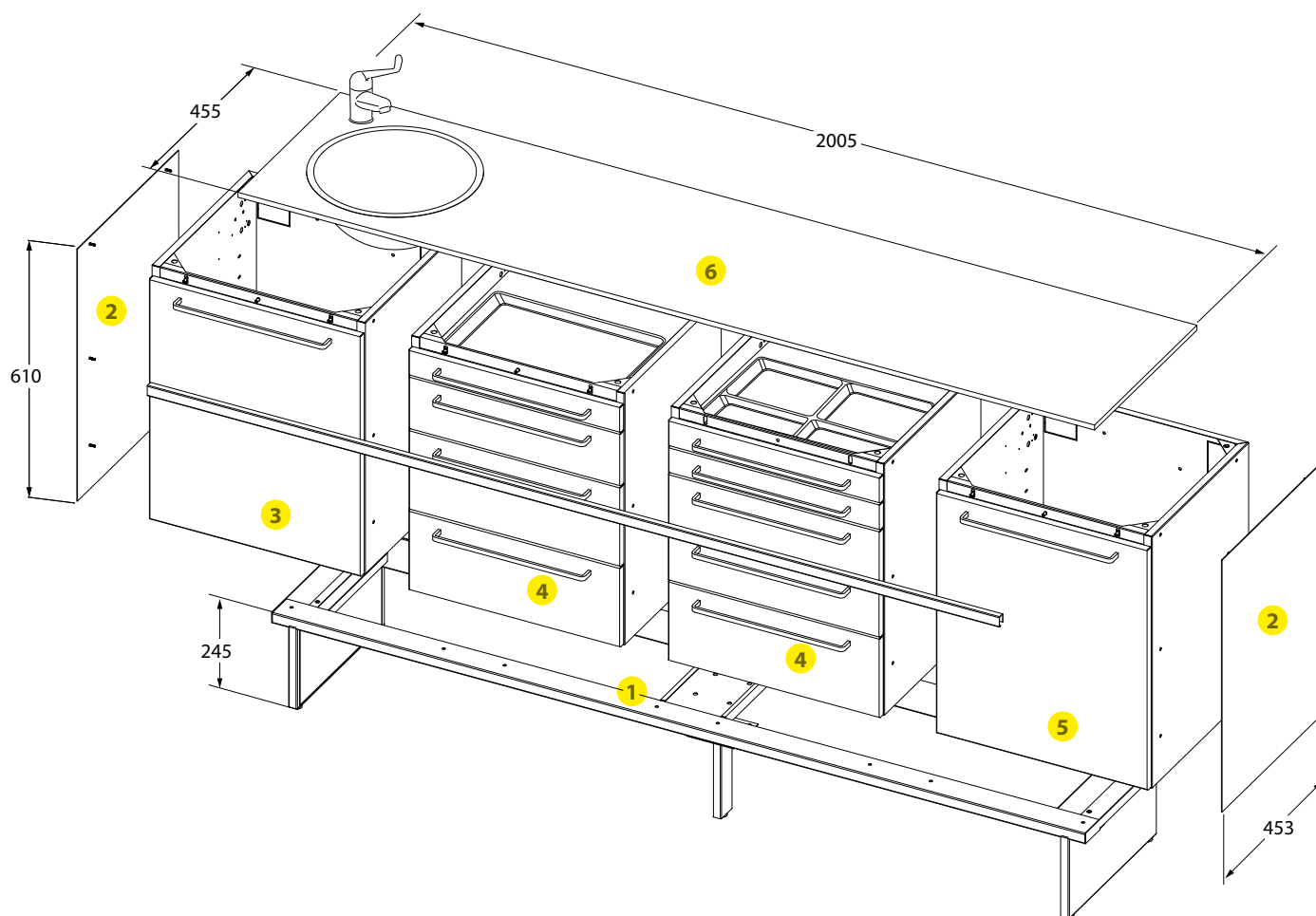

MOBILE LIKE

- 1 Supporto a pavimento
- 2 Fianco laterale
- 3 Mobile lavello
- 4 Mobile con cassetti
- 5 Mobile con anta e due ripiani interni
- 6 Piano con lavello sx

H Sottopiano 860 mm

MOBILIER LIKE

- 1 Support au sol
- 2 Panneau latéral
- 3 Module lavabo
- 4 Module avec tiroirs
- 5 Module avec porte et 2 étagères internes
- 6 Plan avec évier à gauche

H Sous plan de travail 860 mm

UNIT LIKE

- 1 Floor support
- 2 Lateral side
- 3 Sink unit
- 4 Unit with drawers
- 5 Unit with door and 2 interior shelves
- 6 Top with sink on the left side

H Under the top 860 mm

LIKE-MÖBEL

- 1 Bodengestell
- 2 Seitenwand
- 3 Waschbeckenschrank
- 4 Schrank mit Schubladen
- 5 Schrank mit Tür und 2 Einlegeböden
- 6 Arbeitsplatte mit Waschbecken links

H Unter der Arbeitsplatte 860 mm

MUEBLE LIKE

- 1 Soporte de pie
- 2 Panel lateral
- 3 Módulo bajo lavabo
- 4 Módulo con cajones
- 5 Módulo con puerta y dos estantes interiores
- 6 Encimera con lavabo izq.

A Bajo encimera 860 mm

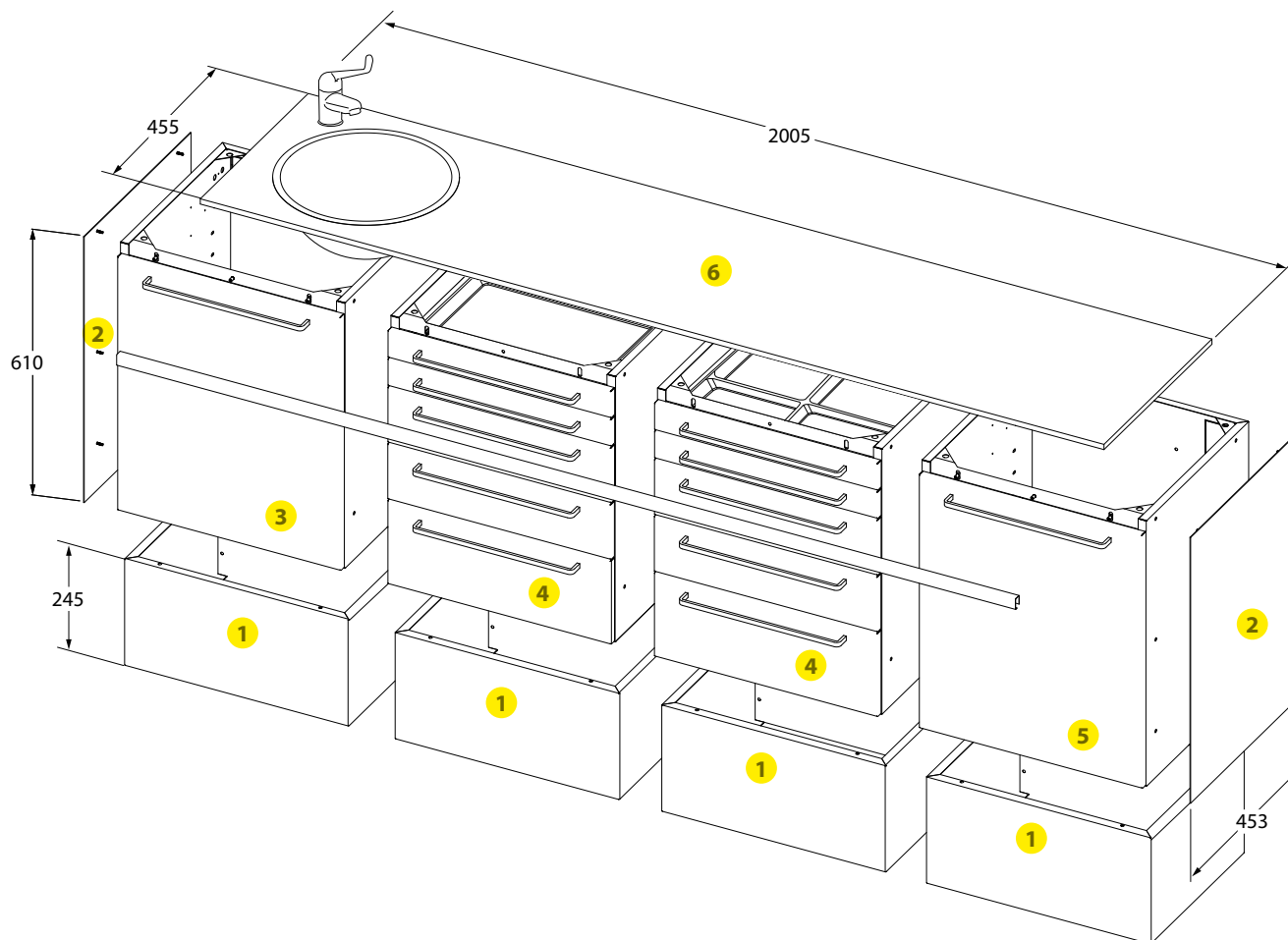

MOBILE LIKE

- 1 Basamento
- 2 Fianco laterale
- 3 Mobile lavello
- 4 Mobile con cassetti
- 5 Mobile con anta e due ripiani interni
- 6 Piano con lavello sx

H Sottopiano 860 mm

MOBILIER LIKE

- 1 Base
- 2 Panneau latéral
- 3 Module lavabo
- 4 Module avec tiroirs
- 5 Module avec porte et 2 étagères internes
- 6 Plan avec évier à gauche

H Sous plan de travail 860 mm

UNIT LIKE

- 1 Base unit
- 2 Lateral side
- 3 Sink unit
- 4 Unit with drawers
- 5 Unit with door and 2 interior shelves
- 6 Top with sink on the left side

H Under the top 860 mm

LIKE-MÖBEL

- 1 Sockel
- 2 Seitenwand
- 3 Waschbeckenschrank
- 4 Schrank mit Schubladen
- 5 Schrank mit Tür und 2 Einlegeböden
- 6 Arbeitsplatte mit Waschbecken links

H Unter der Arbeitsplatte 860 mm

MUEBLE LIKE

- 1 Base
- 2 Panel lateral
- 3 Módulo bajo lavabo
- 4 Módulo con cajones
- 5 Módulo con puerta y dos estantes interiores
- 6 Encimera con lavabo izq.

A Bajo encimera 860 mm

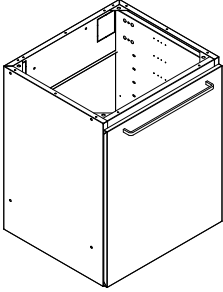
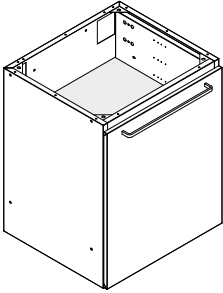
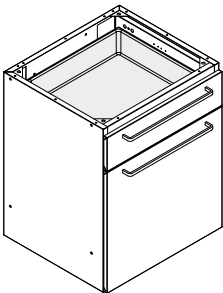
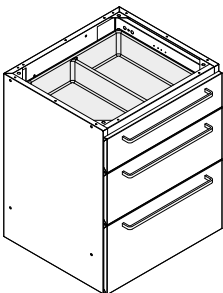
	Descrizione / Description Description / Beschreibung / Descripción	Apertura Opening / Ouverture Öffnung / Apertura	M ³ Kg	Articolo Item / Article Artikel / Artículo	Prezzo Price / Prix Preis / Precio
 <p>MODULO sottolavello con anta "KLAM" o con cassettone estraibile "KLCM", con portarifiuti interno</p> <p>Sink unit with door "KLAM" or pullout drawer "KLCM", with rubbish bin</p> <p>Module lavabo avec porte "KLAM" ou grand tiroir extractible "KLCM", avec poubelle</p> <p>Waschbeckenschrank mit Tür "KLAM" oder Schublade "KLCM", mit Abfalleimer</p> <p>Módulo lavabo con puerta "KLAM" o cajón "KLCM", con cubo de basura</p> <p>L 500 x P 448 x H 610 mm</p>		Maniglia Handle Poignée Griff Tirador	0,25 24,2	KLAM	€ 332,00
			0,25 28,7	KLCM	€ 377,00
			0,25 24	KLAP	€ 358,00
			0,25 28,5	KLCP	€ 487,00
				Push-Pull	
 <p>MODULO con anta e due ripiani interni</p> <p>Unit with door and 2 interior shelves</p> <p>Module avec porte et 2 étagères internes</p> <p>Schrank mit Tür und 2 Einlegeböden</p> <p>Módulo con puerta y dos estantes interiores</p> <p>L 500 x P 448 x H 610 mm</p>		Maniglia Handle Poignée Griff Tirador	0,25 23	KPAM	€ 355,00
 <p>MODULO con cassetto B e anta con 1 ripiano interno</p> <p>Unit with drawer B and door with an interior shelf</p> <p>Module avec 1 tiroir B et porte avec 1 étagère à l'intérieur</p> <p>Schrank mit 1 Schublade B und Tür mit 1 Einlegeboden</p> <p>Módulo con cajón B y puerta con 1 estante interior</p> <p>L 500 x P 448 x H 610 mm</p>		Maniglia Handle Poignée Griff Tirador	0,25 27,5	KPBM	€ 416,00
 <p>MODULO con 3 cassetti: 1 B, 1 C e 1 D</p> <p>Unit with 3 drawers: 1 B, 1 C and 1 D</p> <p>Module avec 3 tiroirs: 1 B, 1 C et 1 D</p> <p>Schrank mit 3 Schubladen: 1 B, 1 C und 1 D</p> <p>Módulo con 3 cajones: 1 B, 1 C y 1 D</p> <p>L 500 x P 448 x H 610 mm</p>		Maniglia Handle Poignée Griff Tirador	0,25 30,4	K3AM	€ 547,00

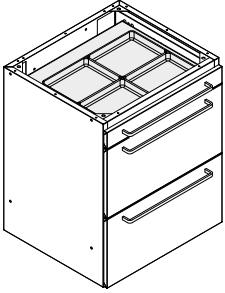
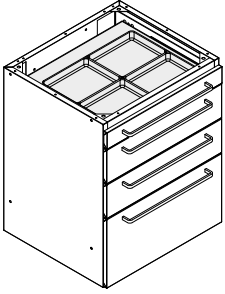
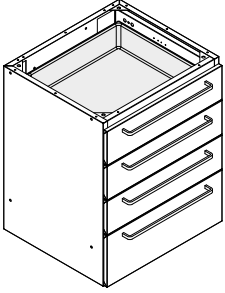
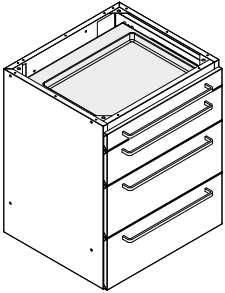
	Descrizione / Description Description / Beschreibung / Descripción	Apertura Opening / Ouverture Öffnung / Apertura	M ³ Kg	Articolo Item / Article Artikel / Artículo	Prezzo Price / Prix Preis / Precio
	<p>MODULO con 3 cassetti: 1 A e 2 D</p> <p>Unit with 3 drawers: 1 A and 2 D Module avec 3 tiroirs: 1 A et 2 D Schrank mit 3 Schubladen: 1 A und 2 D Módulo con 3 cajones: 1 A y 2 D</p> <p>Bacelle / Trays / Intérieurs de tiroir / Einsätze / Bandejas: 1xLBA3, 2xLBC1</p>	<p>Maniglia Handle Poignée Griff Tirador</p>	<p>0,25 30,2</p>	K3BM	€ 551,00
L 500 x P 448 x H 610 mm					
	<p>MODULO con 4 cassetti: 1 A, 2 B e 1 D</p> <p>Unit with 4 drawers: 1 A, 2 B and 1 D Module avec 4 tiroirs: 1 A, 2 B et 1 D Schrank mit 4 Schubladen: 1 A, 2 B und 1 D Módulo con 4 cajones: 1 A, 2B y 1 D</p> <p>Bacelle / Trays / Intérieurs de tiroir / Einsätze / Bandejas: 1xLBA3, 1xLBB1, 1xLBB2, 1xLBC1</p>	<p>Maniglia Handle Poignée Griff Tirador</p>	<p>0,25 33,2</p>	K4AM	€ 620,00
L 500 x P 448 x H 610 mm					
	<p>MODULO con 4 cassetti: 3 B e 1 C</p> <p>Unit with 4 drawers: 3 B and 1 C Module avec 4 tiroirs: 3 B et 1 C Schrank mit 4 Schubladen: 3 B und 1 C Módulo con 4 cajones: 3 B y 1 C</p> <p>Bacelle / Trays / Intérieurs de tiroir / Einsätze / Bandejas: 1xLBB1, 1xLBB2, 1xLBB3, 1xLBC1</p>	<p>Maniglia Handle Poignée Griff Tirador</p>	<p>0,25 33,4</p>	K4BM	€ 637,00
L 500 x P 448 x H 610 mm					
	<p>MODULO con 4 cassetti: 1 A, 1 B e 2 C</p> <p>Unit with 4 drawers: 1 A, 1 B and 2 C Module avec 4 tiroirs: 1 A, 1 B et 2C Schrank mit 4 Schubladen: 1 A, 1 B und 2 C Módulo con 4 cajones: 1 A, 1 B y 2 C</p> <p>Bacelle / Trays / Intérieurs de tiroir / Einsätze / Bandejas: 1xLBA2, 1xLBB3, 2xLBC1</p>	<p>Maniglia Handle Poignée Griff Tirador</p>	<p>0,25 37,8</p>	K4CM	€ 652,00
L 500 x P 448 x H 610 mm					

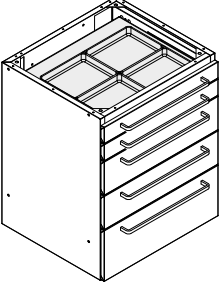
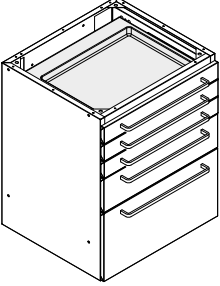
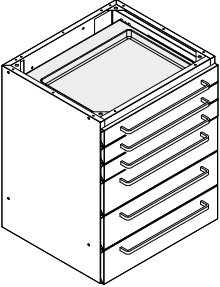
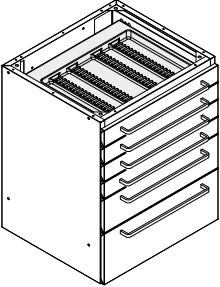
	Descrizione / Description Description / Beschreibung / Descripción	Apertura Opening / Ouverture Öffnung / Apertura	M ³ Kg	Articolo Item / Article Artikel / Artículo	Prezzo Price / Prix Preis / Precio
	<p>MODULO con 5 cassetti: 2 A, 2 B e 1 C</p> <p>Unit with 5 drawers: 2 A, 2 B and 1 C Module avec 5 tiroirs: 2 A, 2 B et 1 C Schrank mit 5 Schubladen: 2 A, 2 B und 1 C Módulo con 5 cajones: 2 A, 2 B y 1 C</p> <p>Bacelle / Trays / Intérieurs de tiroir Einsätze / Bandejas: 1xLBA3, 1xLBA4, 1xLBB1, 1xLBB2, 1xLBC1</p>	Maniglia Handle Poignée Griff Tirador	0,25 36	K5AM	€ 703,00
L 500 x P 448 x H 610 mm					
	<p>MODULO con 5 cassetti: 3 A, 1 B e 1 D</p> <p>Unit with 5 drawers: 3 A, 1 B and 1 D Module avec 5 tiroirs: 3 A, 1 B et 1 D Schrank mit 5 Schubladen: 3 A, 1 B und 1 D Módulo con 5 cajones: 3 A, 1 B y 1 D</p> <p>Bacelle / Trays / Intérieurs de tiroir Einsätze / Bandejas: 1xLBA2, 1xLBA3, 1xLBA4, 1xLBB3, 1xLBC1</p>	Maniglia Handle Poignée Griff Tirador	0,25 35,8	K5BM	€ 686,00
L 500 x P 448 x H 610 mm					
	<p>MODULO con 6 cassetti: 3 A e 3 B</p> <p>Unit with 6 drawers: 3 A and 3 B Module avec 6 tiroirs: 3 A et 3 B Schrank mit 6 Schubladen: 3 A und 3 B Módulo con 6 cajones: 3 A y 3 B</p> <p>Bacelle / Trays / Intérieurs de tiroir / Einsätze / Bandejas: 1xLBA2, 1xLBA3, 1xLBA4, 1xLBB1, 1xLBB2, 1xLBB4</p>	Maniglia Handle Poignée Griff Tirador	0,25 38,8	K6AM	€ 754,00
L 500 x P 448 x H 610 mm					
	<p>MODULO con 6 cassetti: 4 A, 1 B e 1 C</p> <p>Unit with 6 drawers: 4 A, 1 B and 1 C Module avec 6 tiroirs: 4 A, 1 B et 1 C Schrank mit 6 Schubladen: 4 A, 1 B und 1 C Módulo con 6 cajones: 4 A, 1 B y 1 C</p> <p>Bacelle / Trays / Intérieurs de tiroir / Einsätze / Bandejas: 1xLBA1, 1xLBA2, 1xLBA3, 1xLBA4, 1xLBB4, 1xLBC1</p>	Maniglia Handle Poignée Griff Tirador	0,25 38,6	K6BM	€ 770,00
L 500 x P 448 x H 610 mm					

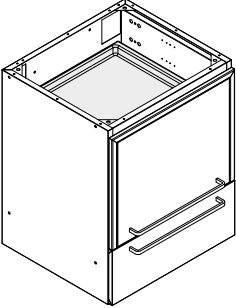
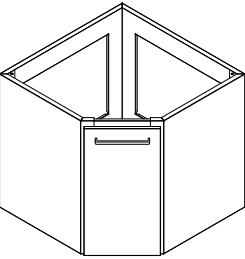
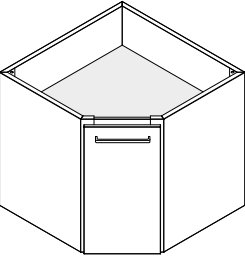
	Descrizione / Description Description / Beschreibung / Descripción	Apertura Opening / Ouverture Öffnung / Apertura	M ³ Kg	Articolo Item / Article Artikel / Artículo	Prezzo Price / Prix Preis / Precio
	<p>MODULO con anta a ribalta con 2 ripiani estraibili per apparecchiature + ciabatta con 3 prese di corrente e cassetto C</p> <p>UNIT with flaps and 2 sliding shelves for equipment + multiple socket with 3 outlets and C-drawer</p> <p>MODULE avec porte à ouverture vers le haut et 2 tablettes extractibles pour dispositifs + prise multiple triple et tiroir C</p> <p>MODUL mit Kipptür und 2 herausziehbaren Fächern für Geräte + Mehrfachstecker mit 3 Steckdosen und Schublade Typ C</p> <p>MÓDULO con puerta basculante con 2 estantes extraíbles para equipos + regleta múltiple con 3 enchufes y cajón C</p>	Maniglia Handle Poignée Griff Tirador	0,25 ----- 30	KRAM	€ 1.051,00
L 500 x P 448 x H 610 mm					
	<p>MODULO angolare sottolavello con anta e portarifiuti interno</p> <p>Corner sink unit with door and rubbish bin</p> <p>Module lavabo d'angle avec porte et poubelle</p> <p>Eckwaschbeckenschrank mit Tür und Abfalleimer</p> <p>Módulo angular lavabo con puerta y cubo de basura</p>	Maniglia Handle Poignée Griff Tirador	0,25 ----- 36	KAAM	€ 653,00
L 700 x P 700 x H 610 mm					
	<p>MODULO angolare con anta e 1 ripiano interno</p> <p>Corner unit with door and 1 interior shelf</p> <p>Module d'angle avec porte et 1 étagère interne</p> <p>Eckschrank mit Tür und 1 Einlegeboden</p> <p>Módulo angular con puerta y estante interior</p>	Maniglia Handle Poignée Griff Tirador	0,25 ----- 35,8	KACM	€ 658,00
L 700 x P 700 x H 610 mm					

LIKE | Moduli

Units / Modules / Schränke / Módulos

LORAN

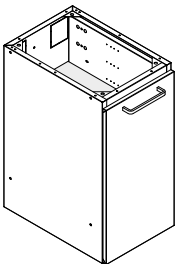
	Descrizione / Description Description / Beschreibung / Descripción	Apertura Opening / Ouverture Öffnung / Apertura	M³ Kg	Articolo Item / Article Artikel / Artículo	Prezzo Price / Prix Preis / Precio
 <p>MODULO con anta e due ripiani interni</p> <p>Unit with door and 2 interior shelves</p> <p>Module avec porte et 2 étagères internes</p> <p>Schrank mit Tür und 2 Einlegeböden</p> <p>Módulo con puerta y dos estantes interiores</p> <p>L 300/400 x P 448 x H 610 mm</p>					
		Maniglia Handle Poignée Griff Tirador	0,25 17	KPDM (L. 300 mm)	€ 355,00
			0,25 18	KPGM (L. 400 mm)	€ 355,00

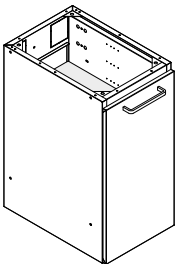
 <p>MODULO con anta e due ripiani interni, con schiena aperta</p> <p>Unit with door and 2 interior shelves, open back</p> <p>Module avec porte et 2 étagères internes, ouvert derrière</p> <p>Schrank mit Tür und 2 Einlegeböden, Rückwand geöffnet</p> <p>Módulo con puerta y dos estantes interiores, con panel trasero abierto</p> <p>L 300 x P 448 x H 610 mm</p>					
	Maniglia Handle Poignée Griff Tirador	0,25 16,5	KPEM	€ 379,00	

LIKE | Servomobili

Movable units / Modules mobiles / Rollenschränke / Módulos móviles

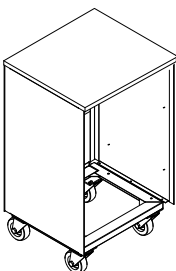
 <p>Kit ruote + piano non sagomato bianco</p> <p>Castor set + top</p> <p>Kit roues + plan</p> <p>Rollenset + Arbeitsplatte</p> <p>Kit de ruedas + encimera</p> <p>L 505 x P 460 x H 790 mm</p>	Stratificato Stratified / Stratifié Schichtstoff Estratificado	0,08 23,3	KRKS	€ 423,00
	Laminato Laminate / Laminé Laminat Laminado	0,08 24,5	KRKL	€ 284,00

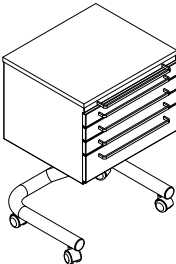
 <p>Modulo su carrello con 4 cassetti: 3 A e 1 B + piano non sagomato</p> <p>Movable unit with 4 drawers: 3A and 1B + top</p> <p>Élément mobile avec 4 tiroirs: 3A et 1B + plan</p> <p>Rollenschränk mit 4 Schubladen: 3A und 1B + Arbeitsplatte</p> <p>Elemento móvil con 4 cajones: 3A y 1B + encimera</p> <p>L 500 x P 445 x H 775 mm</p>	Laminato Laminate / Laminé Laminat Laminado	0,08 38	KSC4L	€ 856,00
	Stratificato Stratified / Stratifié Schichtstoff Estratificado	0,08 37	KSC4S	€ 995,00

LIKE | Supporti a pavimento

Floor supports / Supports au sol / Bodengestelle / Soportes de pie

LORAN

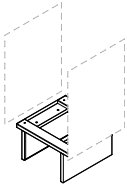
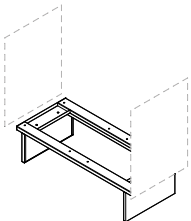
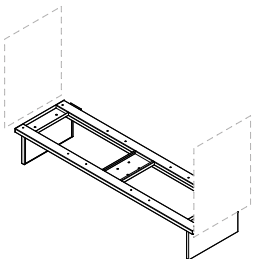
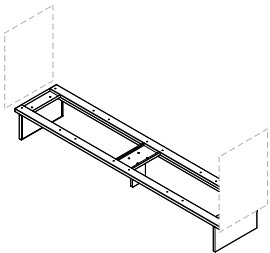
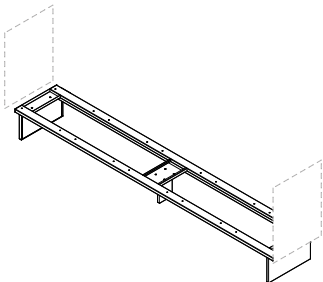
	Descrizione / Description Description / Beschreibung / Descripción	M ³ Kg	Articolo Item / Article Artikel / Artículo	Prezzo Price / Prix Preis / Precio
	<p>SUPPORTO a pavimento per 1 modulo lineare/angolare</p> <p>Floor support for 1 unit / corner support Support au sol pour 1 module / support d'angle Bodengestell für 1 Schrank / Eckgestell Soporte de pie para 1 módulo / soporte angular</p>	0,14 11	KS1V	€ 187,00
L 500 mm				
	<p>SUPPORTO a pavimento per 2 moduli</p> <p>Floor support for 2 units Support au sol pour 2 modules Bodengestell für 2 Schränke Soporte de pie para 2 módulos</p>	0,26 13	KS2V	€ 236,00
L 1000 mm				
	<p>SUPPORTO a pavimento per 3 moduli</p> <p>Floor support for 3 units Support au sol pour 3 modules Bodengestell für 3 Schränke Soporte de pie para 3 módulos</p>	0,35 17	KS3V	€ 304,00
L 1500 mm				
	<p>SUPPORTO a pavimento per 4 moduli</p> <p>Floor support for 4 units Support au sol pour 4 modules Bodengestell für 4 Schränke Soporte de pie para 4 módulos</p>	0,50 20	KS4V	€ 394,00
L 2000 mm				
	<p>SUPPORTO a pavimento per 5 moduli</p> <p>Floor support for 5 units Support au sol pour 5 modules Bodengestell für 5 Schränke Soporte de pie para 5 módulos</p>	0,54 24	KS5V	€ 456,00
L 2500 mm				

VELA

LOOK

LIKE

ALA/QUADRO
NOVO/UPRIGHTMOVINGTRAY
MOVING ARMPURA
PURASTUDIO

STERIL K

CART

ARMADI

BACINELLE

PIANI
ALZATINELAVELLI
RUBINETTILAVORAZIONI
ACCESSORIOPEN BOX
SEGGIOLINI

PROF



MAESTRO

IMPIANTISTICA

LIKE | Basamenti

Base units / Bases / Sockel / Bases

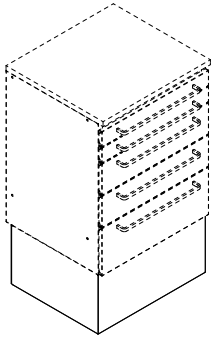
LORAN

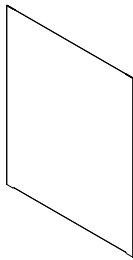
	Descrizione / Description Description / Beschreibung / Descripción	M ³ Kg	Articolo Item / Article Artikel / Artículo	Prezzo Price / Prix Preis / Precio
	Basamento angolare Corner base unit - Base d'angle Ecksockel - Base angular	- 6,5	KB01	€ 201,00
	L 685 x P 685 x H 245 mm			
	Basamento / Base unit / Base Sockel / Base: L 300	- 3	KB02	€ 65,00
	L 300 x P 395 x H 245 mm			
	Basamento / Base unit / Base Sockel / Base: L 400	- 4	KB06	€ 65,00
	L 400 x P 395 x H 245 mm			
	Basamento / Base unit / Base Sockel / Base: L 500	- 5	KB03	€ 65,00
	L 500 x P 395 x H 245 mm			
	FIANCO laterale Lateral side Panneau latéral Seitenwand Panel lateral	- 3,8	KFV45 (P. 455)	€ 48,00
	Verniciato Painted / Verni Lackiert / Pintado	- 4,2 - 5	KFV50 (P. 505) KFV60 (P. 600)	€ 61,00 € 69,00

LIKE | Accessori, Ricambi

Accessories, Spare parts / Accessoires, Pièces détachées / Zubehör, Ersatzteile / Accesorios, Recambios

	Pannello laterale verniciato di sostegno piano Painted top-support side panel Panneau latéral verni, de support pour le plan Lackierte Abschlußverkleidung Panel lateral pintado para el soporte de la encimera	- 8	LSLS	€ 182,00
	L 25 x P 430 x H 860 mm			
	MANIGLIA in alluminio per "Like" Aluminium handle for "Like" Poignée en aluminium pour "Like" Griff aus Aluminium für "Like" Tirador de aluminio para "Like"	- 0,4	MA032	€ 24,00
	L 1000 x P 16 x H 25 mm			
	Sottopiano "Like": al metro lineare Undercounter "Like": per meter Sous plan "Like": au mètre Unterbau "Like": je meter De Baio de la encimera "Like": al m.	- 1	KSPA	€ 27,00
	L 1000 x P 16 x H 25 mm			

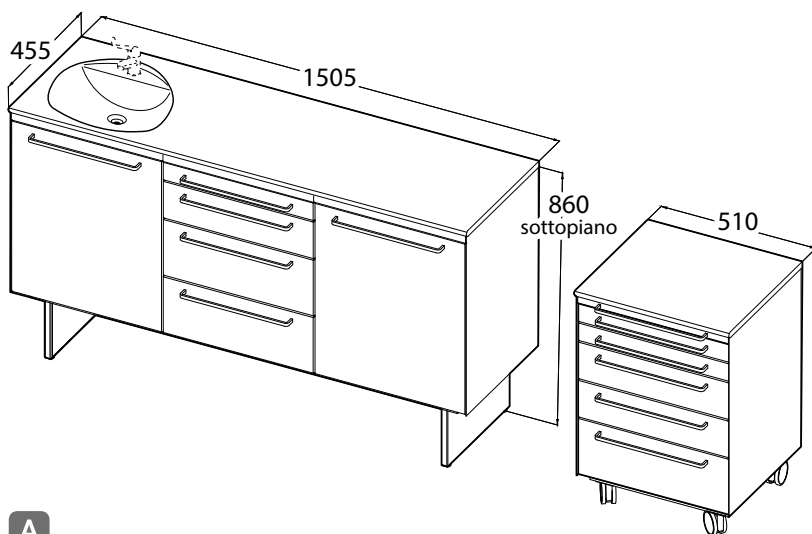

A

COMPOSIZIONE / COMPOSITION / COMPOSITION
ZUSAMMENSTELLUNG / COMPOSICIÓN

KLAM + K4CM + KPAM + K5AM + KRK

La composizione è comprensiva di bacinelle standard. Rubinetto escluso.

Trays included. Mixer excluded
Intérieurs de tiroirs inclus. Robinet pas compris.
Standard Schubladeneinsätze sind enthalten.
Armatur ist ausgeschlossen.
La composición incluye bandejas estándar.
Grifo excluido.

Con piedi / On feet
Sur pieds / Mit Füßen /
Con patas

Basamento / Base units
/ Bases / Sockel / Bases

Maniglia
Handle / Poignée
Griff / Tirador

Maniglia
Handle / Poignée
Griff / Tirador

	+VCF	€ 3.378,00	€ 3.269,00
Piano in laminato Laminate worktop / Plan de travail en laminé / Arbeitsplatte aus Laminat / Encimera de laminado			
Piano in stratificato Stratified top / Plan stratifié / Arbeitsplatte aus Schichtstoff / Encimera de estratificado	+VCS	€ 4.065,00	€ 3.956,00

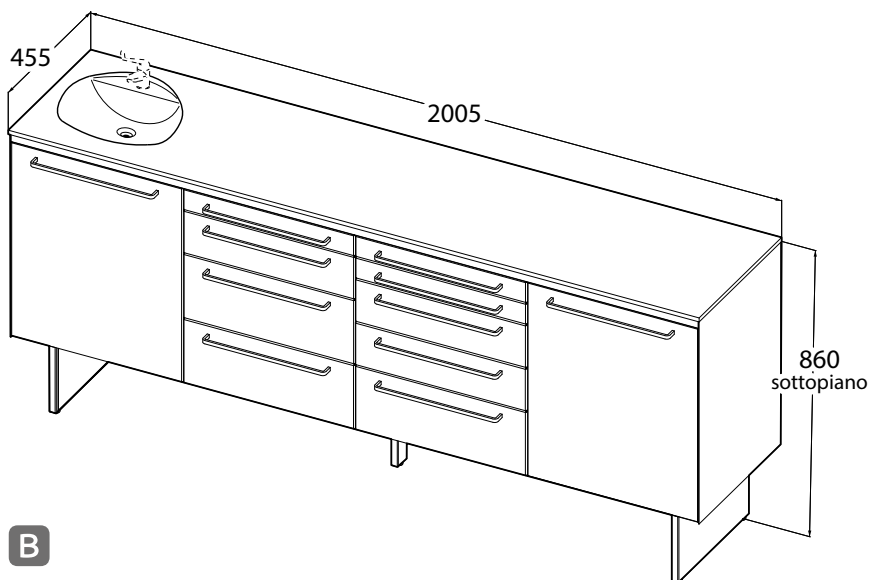

B

COMPOSIZIONE / COMPOSITION / COMPOSITION
ZUSAMMENSTELLUNG / COMPOSICIÓN

KLAM + K4CM + K5AM + KPAM

La composizione è comprensiva di bacinelle standard. Rubinetto escluso.

Trays included. Mixer excluded
Intérieurs de tiroirs inclus. Robinet pas compris.
Standard Schubladeneinsätze sind enthalten.
Armatur ist ausgeschlossen.
La composición incluye bandejas estándar.
Grifo excluido.

Con piedi / On feet
Sur pieds / Mit Füßen /
Con patas

Basamento / Base units
/ Bases / Sockel / Bases

Maniglia
Handle / Poignée
Griff / Tirador

Maniglia
Handle / Poignée
Griff / Tirador

	+VCF	€ 3.267,00	€ 3.132,00
Piano in laminato Laminate worktop / Plan de travail en laminé / Arbeitsplatte aus Laminat / Encimera de laminado			
Piano in stratificato Stratified top / Plan stratifié / Arbeitsplatte aus Schichtstoff / Encimera de estratificado	+VCS	€ 3.958,00	€ 3.824,00

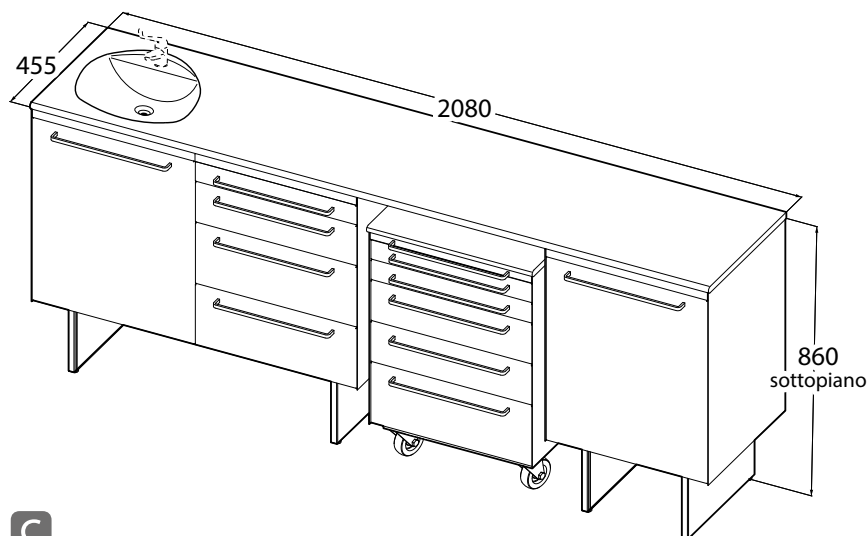

C

COMPOSIZIONE / COMPOSITION / COMPOSITION
ZUSAMMENSTELLUNG / COMPOSICIÓN

KLAM + K4CM + K5AM + KRK + KPAM

La composizione è comprensiva di bacinelle standard. Rubinetto escluso.

Trays included. Mixer excluded
Intérieurs de tiroirs inclus. Robinet pas compris.
Standard Schubladeneinsätze sind enthalten.
Armatur ist ausgeschlossen.
La composición incluye bandejas estándar.
Grifo excluido.

Con piedi / On feet
Sur pieds / Mit Füßen /
Con patas

Basamento / Base units
/ Bases / Socket / Bases

Maniglia
Handle / Poignée
Griff / Tirador

Maniglia
Handle / Poignée
Griff / Tirador

	Con piedi / On feet Sur pieds / Mit Füßen / Con patas	Basamento / Base units / Bases / Socket / Bases
Piano in laminato Laminate worktop / Plan de travail en laminé / Arbeitsplatte aus Laminat / Encimera de laminado	+VCF € 3.686,00	€ 3.459,00
Piano in stratificato Stratified top / Plan stratifié / Arbeitsplatte aus Schichtstoff / Encimera de estratificado	+VCS € 4.540,00	€ 4.312,00

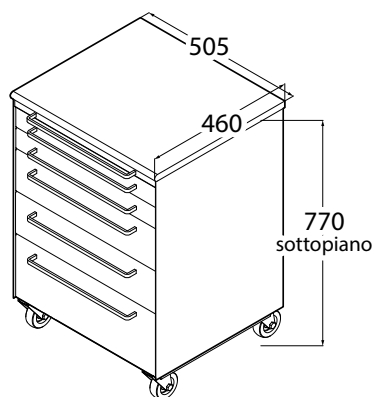

D

SERVOMOBILE / MOVABLE UNIT / MODULE MOBILE
/ ROLLENSCHRANK / MÓDULO MÓVIL

K5AM + KRK

Il servomobile è comprensivo di bacinelle standard.

Trays included.
Intérieurs de tiroirs inclus.
Standard Schubladeneinsätze sind enthalten.
La composición incluye bandejas estándar.

Maniglia
Handle / Poignée
Griff / Tirador

Piano in laminato Laminate worktop / Plan de travail en laminé / Arbeitsplatte aus Laminat / Encimera de laminado	€ 987,00
Piano in stratificato Stratified top / Plan stratifié / Arbeitsplatte aus Schichtstoff / Encimera de estratificado	€ 1.126,00

VELA

LOOK

LIKE

ALA / QUADRO
NOVO / UPRIGHT

MOVINGTRAY
MOVING ARM

PURA
PURASTUDIO

STERIL K

CART

ARMADI

BACINELLE

PIANI
ALZATINE

LAVELLI
RUBINETTI

LAVORAZIONI
ACCESSORI

OPEN BOX
SEGGIOLINI

PROF

MAESTRO

IMPIANTISTICA

Descrizione / Description
Description / Beschreibung / Descripción

M³
Kg

Articolo
Item / Article
Artikel / Artículo

Prezzo
Price / Prix
Preis / Precio



L 1030 x P 200 x H 400 mm

PENSILE CON ANTA A RIBALTA VERNICIATA

Wall unit with painted flap door / Elément mural avec porte vernie avec ouverture vers le haut / Hängeschrank mit lackierten Tür mit Öffnung nach oben / Mueble colgante con puerta pintada abatible

0,15
32

ALA10

€ 1.208,00

PENSILE CON ANTA A RIBALTA IN VETRO

Wall unit with glass flap door / Elément mural avec porte en verre avec ouverture vers le haut / Hängeschrank mit Glastür mit Öffnung nach oben / Mueble colgante con puerta de vidrio abatible

0,15
30

ALA10V

€ 1.463,00

PENSILE CON ANTA A RIBALTA A SPECCHIO

Wall units with mirror flap door / Elément mural avec porte avec miroir avec ouverture vers le haut / Hängeschrank mit Spiegeltür mit Öffnung nach oben / Mueble colgante con puerta con espejo abatible

0,15
30

ALA10S

€ 1.648,00

Completo di:

n. 1 distributore di bicchieri **Infratronic**; n. 1 distributore di sapone automatico con fotocellula;
n. 2 alloggiamenti per guanti o salviette; n. 1 alloggiamento per mascherine;
n. 2 portarotolo per carta e mantelline.

Complete of:

n. 1 **Infratronic** glass dispenser; n. 1 photocell-controlled soap dispenser;
n. 2 spaces for gloves and serviettes; n. 1 place for face masks;
n. 2 paper roll and cape carriers.

Composé de:

n. 1 distributeur de gobelets **Infratronic**; n. 1 distributeur de savon automatique avec cellule photoélectrique;
n. 2 logements pour gants ou serviettes; n. 1 logement pour masques;
n. 2 supports de rouleau pour papier et capes.

Komplett mit:

n. 1 **Infratronic** Verteiler von Bechern; n. 1 automatischer Seifenspender mit Lichtschranke;
n. 2 Platz für Handschuhe oder Servietten; n. 1 Steckplatz für Maskern;
n. 2 Papierrollenträger und Schulterumhänge.

Dotado de:

n. 1 dispensador de vasos **Infratronic**; n. 1 dispensador de jabón automático con fotocélula;
n. 2 alojamiento para guantes servilletas; n. 1 alojamiento para mascarillas; n. 1 alojamiento para mordazas y/o cánulas; n. 2 porta rollo para papel y capas.

Descrizione / Description
Description / Beschreibung / Descripción

M³
Kg

Articolo
Item / Article
Artikel / Artículo

Prezzo
Price / Prix
Preis / Precio



L 1530 x P 200 x H 400 mm

PENSILE CON ANTA A RIBALTA VERNICIATA

Wall unit with painted flap door / Elément mural avec porte vernie avec ouverture vers le haut / Hängeschrank mit lackierten Tür mit Öffnung nach oben / Mueble colgante con puerta pintada abatible

0,22
51

ALA15

€ 1.453,00

PENSILE CON ANTA A RIBALTA IN VETRO

Wall unit with glass flap door / Elément mural avec porte en verre avec ouverture vers le haut / Hängeschrank mit Glastür mit Öffnung nach oben / Mueble colgante con puerta de vidrio abatible

0,22
49

ALA15V

€ 1.710,00

PENSILE CON ANTA A RIBALTA A SPECCHIO

Wall units with mirror flap door / Elément mural avec porte avec miroir avec ouverture vers le haut / Hängeschrank mit Spiegeltür mit Öffnung nach oben / Mueble colgante con puerta abatible

0,22
49

ALA15S

€ 1.954,00

Completo di:

n. 1 distributore di bicchieri **Infratronic**; n. 1 distributore di sapone automatico con fotocellula;
n. 3 alloggiamenti per guanti o salviette; n. 1 alloggiamento per mascherine;
n. 1 alloggiamento per bavagli o canule; n. 2 portarotolo per carta e mantelline.

Complete of:

n. 1 **Infratronic** glass dispenser; n. 1 photocell-controlled soap dispenser;
n. 3 spaces for gloves and serviettes; n. 1 place for face masks;
n. 1 place for bibs and cannulas; n. 2 paper roll and cape carriers.

Composé de:

n. 1 distributeur de gobelets **Infratronic**; n. 1 distributeur de savon automatique avec cellule photoélectrique; n. 3 logements pour gants ou serviettes; n. 1 logement pour masques;
n. 1 logement pour bavoires ou canules; n. 2 supports de rouleau pour papier et capes.

Komplett mit:

n. 1 **Infratronic** Verteiler von Bechern; n. 1 automatischer Seifenspender mit Lichtschranke;
n. 3 Platz für Handschuhe oder Servietten; n. 1 Steckplatz für Masken;
n. 1 Steckplatz für Lätzchen oder Kanülen; n. 2 Papierrollenträger und Schulterumhänge.

Dotado de:

n. 1 dispensador de vasos **Infratronic**; n. 1 dispensador de servilletas; n. 1 dispensador de jabón automático con fotocélula; n. 3 alojamientos para guantes o servilletas;
n. 1 alojamiento para mascarillas; n. 1 alojamiento para mordazas o cánulas; n. 2 porta rollo para papel y capas.

ALA Round | Pensili

Wall units / Eléments muraux / Hängeschränke / Muebles colgantes

LORAN

Descrizione / Description
Description / Beschreibung / Descripción

M³
Kg

Articolo
Item / Article
Artikel / Artículo

Prezzo
Price / Prix
Preis / Precio

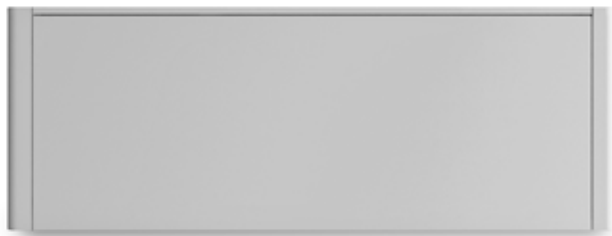

L 1092 x P 200 x H 400 mm

PENSILE CON ANTA A RIBALTA VERNICIATA E FIANCHI ROUND

Wall unit with painted flap door and Round sides / Élément mural avec porte vernie avec ouverture vers le haut et panneau latéral Round / Hängeschrank mit lackierten Tür mit Öffnung nach oben mit Round Seitenwand / Mueble colgante con puerta pintada abatible y panel lateral Round

0,15
32

ALA10R € 1.392,00

Completo di:

n. 1 distributore di bicchieri **Infratronic**; n. 1 distributore di sapone automatico con fotocellula;
n. 2 alloggiamenti per guanti o salviette; n. 1 alloggiamento per mascherine;
n. 2 portarotolo per carta e mantelline.

Complete of:

n. 1 **Infratronic** glass dispenser; n. 1 photocell-controlled soap dispenser;
n. 2 spaces for gloves and serviettes; n. 1 place for face masks;
n. 2 paper roll and cape carriers.

Composé de:

n. 1 distributeur de gobelets **Infratronic**; n. 1 distributeur de savon automatique avec cellule photoélectrique;
n. 2 logements pour gants ou serviettes; n. 1 logement pour masques;
n. 2 supports de rouleau pour papier et capes.

Komplett mit:

n. 1 **Infratronic** Verteiler von Bechern; n. 1 automatischer Seifenspender mit Lichtschranke;
n. 2 Platz für Handschuhe oder Servietten; n. 1 Steckplatz für Maskern;
n. 2 Papierrollenträger und Schulterumhänge.

Dotado de:

n. 1 dispensador de vasos **Infratronic**; n. 1 dispensador de jabón automático con fotocélula;
n. 2 alojamiento para guantes servilletas; n. 1 alojamiento para mascarillas; n. 1 alojamiento para mordazas y/o cánulas; n. 2 porta rollo para papel y capas.

VELA

LOOK

LIKE

ALA/QUADRO
NOVO/UPRIGHT

MOVINGTRAY
MOVING ARM

PURA
PURASTUDIO

STERIL K

CART

ARMADI

BACINELLE

PIANI
ALZATINE

LAVELLI
RUBINETTI

LAVORAZIONI
ACCESSORI

OPEN BOX
SEGGIOLINI

PROF

MAESTRO

IMPIANTISTICA

ALA Round | Pensili

Wall units / Eléments muraux / Hängeschränke / Muebles colgantes

LORAN

Descrizione / Description
Description / Beschreibung / Descripción

M³
Kg

Articolo
Item / Article
Artikel / Artículo

Prezzo
Price / Prix
Preis / Precio

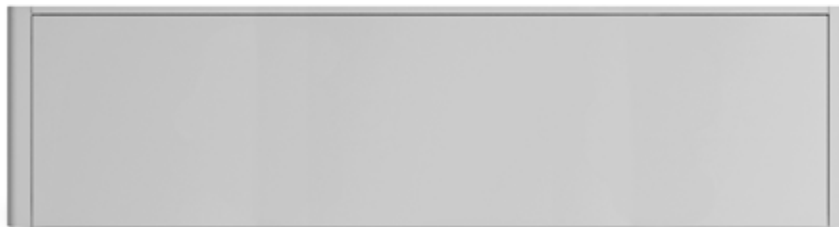

L 1592 x P 200 x H 400 mm

PENSILE CON ANTA A RIBALTA VERNICIATA E FIANCHI ROUND

Wall unit with painted flap door and Round sides / Elément mural avec porte vernie avec ouverture vers le haut et panneau latéral Round / Hängeschrank mit lackierten Tür mit Öffnung nach oben mit Round Seitenwand / Mueble colgante con puerta pintada abatible y panel lateral Round

0,22
51

ALA15R

€ 1.637,00

Completo di:

n. 1 distributore di bicchieri **Infratronic**; n. 1 distributore di sapone automatico con fotocellula;
n. 3 alloggiamenti per guanti o salviette; n. 1 alloggiamento per mascherine;
n. 1 alloggiamento per bavagli o canule; n. 2 portarotolo per carta e mantelline.

Complete of:

n. 1 **Infratronic** glass dispenser; n. 1 photocell-controlled soap dispenser;
n. 3 spaces for gloves and serviettes; n. 1 place for face masks;
n. 1 place for bibs and cannulas; n. 2 paper roll and cape carriers.

Composé de:

n. 1 distributeur de gobelets **Infratronic**; n. 1 distributeur de savon automatique avec cellule photoélectrique; n. 3 logements pour gants ou serviettes; n. 1 logement pour masques;
n. 1 logement pour bavoires ou canules; n. 2 supports de rouleau pour papier et capes.

Komplett mit:

n. 1 **Infratronic** Verteiler von Bechern; n. 1 automatischer Seifenspender mit Lichtschranke;
n. 3 Platz für Handschuhe oder Servietten; n. 1 Steckplatz für Masken;
n. 1 Steckplatz für Lätzchen oder Kanülen; n. 2 Papierrollenträger und Schulterumhänge.

Dotado de:

n. 1 dispensador de vasos **Infratronic**; n. 1 dispensador de servilletas; n. 1 dispensador de jabón automático con fotocélula; n. 3 alojamientos para guantes o servilletas;
n. 1 alojamiento para mascarillas; n. 1 alojamiento para mordazas o cánulas; n. 2 porta rollo para papel y capas.

VELA

LOOK

LIKE

ALA/QUADRO
NOVO/UPRIGHT

MOVINGTRAY
MOVING ARM

PURA
PURASTUDIO

STERIL K

CART

ARMADI

BACINELLE

PIANI
ALZATINE

LAVELLI
RUBINETTI

LAVORAZIONI
ACCESSORI

OPEN BOX
SEGGIOLINI

PROF

MAESTRO

IMPIANTISTICA

Descrizione / Description
Description / Beschreibung / Descripción

M³
Kg

Articolo
Item / Article
Artikel / Artículo

Prezzo
Price / Prix
Preis / Precio

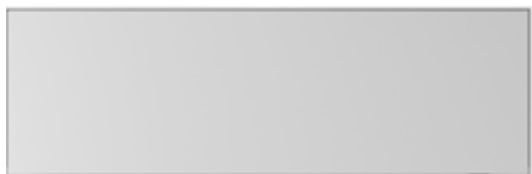

L 1008 x P 200 x H 304 mm

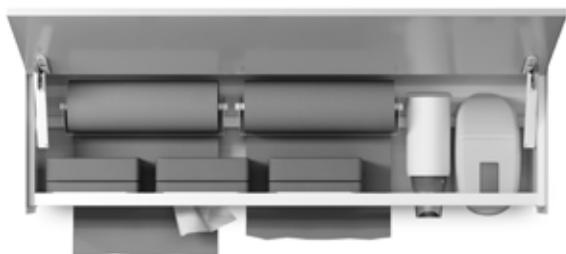

PENSILE CON ANTA A RIBALTA VERNICIATA

Wall unit with painted flap door / Elément mural avec porte vernie avec ouverture vers le haut / Hängeschrank mit lackierten Tür mit Öffnung nach oben / Mueble colgante con puerta pintada abatible

Completo di:

n. 1 distributore di bicchieri **Infratronic**; n. 1 distributore di sapone automatico con fotocellula;
n. 2 alloggiamenti per guanti o salviette; n. 1 alloggiamento per mascherine;
n. 2 portarotolo per carta e mantelline.

Complete of:

n. 1 **Infratronic** glass dispenser; n. 1 photocell-controlled soap dispenser;
n. 2 spaces for gloves and serviettes; n. 1 place for face masks;
n. 2 paper roll and cape carriers.

Composé de:

n. 1 distributeur de gobelets **Infratronic**; n. 1 distributeur de savon automatique avec cellule photoélectrique;
n. 2 logements pour gants ou serviettes; n. 1 logement pour masques;
n. 2 supports de rouleau pour papier et capes.

Komplett mit:

n. 1 **Infratronic** Verteiler von Bechern; n. 1 automatischer Seifenspender mit Lichtschranke;
n. 2 Platz für Handschuhe oder Servietten; n. 1 Steckplatz für Maskern;
n. 2 Papierrollenträger und Schulterumhänge.

Dotado de:

n. 1 dispensador de vasos **Infratronic**; n. 1 dispensador de jabón automático con fotocélula;
n. 2 alojamiento para guantes servilletas; n. 1 alojamiento para mascarillas; n. 1 alojamiento para mordazas y/o cánulas; n. 2 porta rollo para papel y capas.

-
-
-

ALAL10 € 1.269,00

VELA

LOOK

LIKE

ALA/QUADRO
NOVO/UPRIGHT

MOVINGTRAY
MOVING ARM

PURA
PURASTUDIO

STERIL K

CART

ARMADI

BACINELLE

PIANI
ALZATINE

LAVELLI
RUBINETTI

LAVORAZIONI
ACCESSORI

OPEN BOX
SEGGIOLINI

PROF

MAESTRO

IMPIANTISTICA

Descrizione / Description
Description / Beschreibung / Descripción

M³
Kg

Articolo
Item / Article
Artikel / Artículo

Prezzo
Price / Prix
Preis / Precio

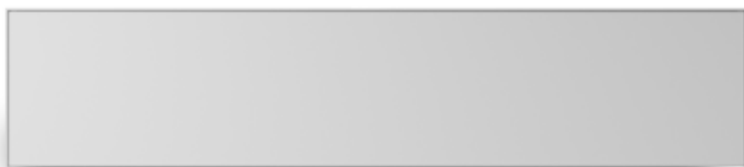

L 1508 x P 200 x H 304 mm

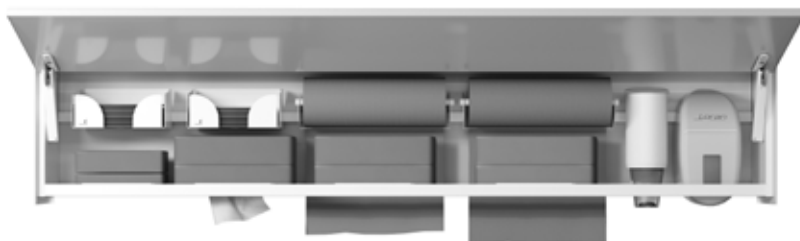

PENSILE CON ANTA A RIBALTA VERNICIATA

Wall unit with painted flap door / Elément mural avec porte vernie avec ouverture vers le haut / Hängeschrank mit lackierten Tür mit Öffnung nach oben / Mueble colgante con puerta pintada abatible

-
-
- ALAL15 € 1.484,00

Completo di:

n. 1 distributore di bicchieri **Infratronic**; n. 1 distributore di sapone automatico con fotocellula;
n. 3 alloggiamenti per guanti o salviette; n. 1 alloggiamento per mascherine;
n. 1 alloggiamento per bavagli o canule; n. 2 portarotolo per carta e mantelline.

Complete of:

n. 1 **Infratronic** cup dispenser; n. 1 photocell-controlled soap dispenser;
n. 3 spaces for gloves and serviettes; n. 1 place for face masks;
n. 1 place for bibs and cannulas; n. 2 paper roll and cape carriers.

Composé de:

n. 1 distributeur de gobelets **Infratronic**; n. 1 distributeur de savon automatique avec cellule photoélectrique; n. 3 logements pour gants ou serviettes; n. 1 logement pour masques;
n. 1 logement pour bavoires ou canules; n. 2 supports de rouleau pour papier et capes.

Komplett mit:

n. 1 **Infratronic** Verteiler von Bechern; n. 1 automatischer Seifenspender mit Lichtschranke;
n. 3 Platz für Handschuhe oder Servietten; n. 1 Steckplatz für Masken;
n. 1 Steckplatz für Lätzchen oder Kanülen; n. 2 Papierrollenträger und Schulterumhänge.

Dotado de:

n. 1 dispensador de vasos **Infratronic**; n. 1 dispensador de servilletas; n. 1 dispensador de jabón automático con fotocélula; n. 3 alojamientos para guantes o servilletas;
n. 1 alojamiento para mascarillas; n. 1 alojamiento para mordazas o cánulas; n. 2 porta rollo para papel y capas.

VELA

LOOK

LIKE

ALA/QUADRO
NOVO/UPRIGHT

MOVINGTRAY
MOVING ARM

PURA
PURASTUDIO

STERIL K

CART

ARMADI

BACINELLE

PIANI
ALZATINE

LAVELLI
RUBINETTI

LAVORAZIONI
ACCESSORI

OPEN BOX
SEGGIOLINI

PROF

MAESTRO

IMPIANTISTICA

ALA LEAN Round | Pensili

Wall units / Eléments muraux / Hängeschränke / Muebles colgantes

LORAN

Descrizione / Description
Description / Beschreibung / Descripción

M³
Kg

Articolo
Item / Article
Artikel / Artículo

Prezzo
Price / Prix
Preis / Precio

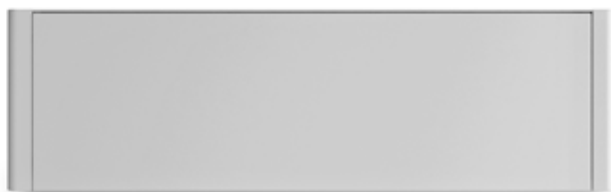

L 1092 x P 200 x H 304 mm

PENSILE CON ANTA A RIBALTA VERNICIATA E FIANCHI ROUND

Wall unit with painted flap door and Round sides / Élément mural avec porte vernie avec ouverture vers le haut et panneau latéral Round / Hängeschrank mit lackierten Tür mit Öffnung nach oben mit Round Seitenwand / Mueble colgante con puerta pintada abatible y panel lateral Round

Completo di:

n. 1 distributore di bicchieri **Infratronic**; n. 1 distributore di sapone automatico con fotocellula;
n. 2 alloggiamenti per guanti o salviette; n. 1 alloggiamento per mascherine;
n. 2 portarotolo per carta e mantelline.

Complete of:

n. 1 **Infratronic** glass dispenser; n. 1 photocell-controlled soap dispenser;
n. 2 spaces for gloves and serviettes; n. 1 place for face masks;
n. 2 paper roll and cape carriers.

Composé de:

n. 1 distributeur de gobelets **Infratronic**; n. 1 distributeur de savon automatique avec cellule photoélectrique;
n. 2 logements pour gants ou serviettes; n. 1 logement pour masques;
n. 2 supports de rouleau pour papier et capes.

Komplett mit:

n. 1 **Infratronic** Verteiler von Bechern; n. 1 automatischer Seifenspender mit Lichtschranke;
n. 2 Platz für Handschuhe oder Servietten; n. 1 Steckplatz für Maskern;
n. 2 Papierrollenträger und Schulterumhänge.

Dotado de:

n. 1 dispensador de vasos **Infratronic**; n. 1 dispensador de jabón automático con fotocélula;
n. 2 alojamiento para guantes servilletas; n. 1 alojamiento para mascarillas; n. 1 alojamiento para mordazas y/o cánulas; n. 2 porta rollo para papel y capas.

-
- ALAL10R € 1.453,00

VELA

LOOK

LIKE

ALA / QUADRO
NOVO / UPRIGHT

MOVINGTRAY
MOVING ARM

PURA
PURASTUDIO

STERIL K

CART

ARMADI

BACINELLE

PIANI
ALZATINE

LAVELLI
RUBINETTI

LAVORAZIONI
ACCESSORI

OPEN BOX
SEGGIOLINI

PROF

MAESTRO

IMPIANTISTICA

ALA LEAN Round | Pensili

Wall units / Eléments muraux / Hängeschränke / Muebles colgantes

LORAN

Descrizione / Description
Description / Beschreibung / Descripción

M³
Kg

Articolo
Item / Article
Artikel / Artículo

Prezzo
Price / Prix
Preis / Precio

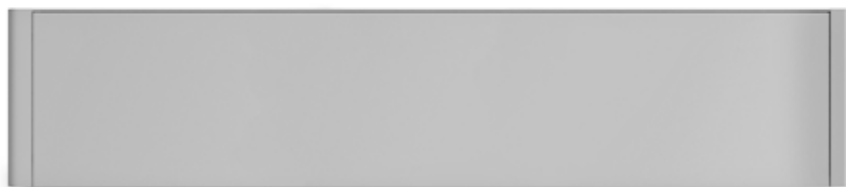

L 1592 x P 200 x H 304 mm

PENSILE CON ANTA A RIBALTA VERNICIATA E FIANCHI ROUND

Wall unit with painted flap door and Round sides / Elément mural avec porte vernie avec ouverture vers le haut et panneau latéral Round / Hängeschrank mit lackierten Tür mit Öffnung nach oben mit Round Seitenwand / Mueble colgante con puerta pintada abatible y panel lateral Round

-
- ALAL15R € 1.668,00

Completo di:

n. 1 distributore di bicchieri **Infratronic**; n. 1 distributore di sapone automatico con fotocellula;
n. 3 alloggiamenti per guanti o salviette; n. 1 alloggiamento per mascherine;
n. 1 alloggiamento per bavagli o canule; n. 2 portarotolo per carta e mantelline.

Complete of:

n. 1 **Infratronic** cup dispenser; n. 1 photocell-controlled soap dispenser;
n. 3 spaces for gloves and serviettes; n. 1 place for face masks;
n. 1 place for bibs and cannulas; n. 2 paper roll and cape carriers.

Composé de:

n. 1 distributeur de gobelets **Infratronic**; n. 1 distributeur de savon automatique avec cellule photoélectrique; n. 3 logements pour gants ou serviettes; n. 1 logement pour masques;
n. 1 logement pour bavoirs ou canules; n. 2 supports de rouleau pour papier et capes.

Komplett mit:

n. 1 **Infratronic** Verteiler von Bechern; n. 1 automatischer Seifenspender mit Lichtschranke;
n. 3 Platz für Handschuhe oder Servietten; n. 1 Steckplatz für Masken;
n. 1 Steckplatz für Lätzchen oder Kanülen; n. 2 Papierrollenträger und Schulterumhänge.

Dotado de:

n. 1 dispensador de vasos **Infratronic**; n. 1 dispensador de servilletas; n. 1 dispensador de jabón automático con fotocélula; n. 3 alojamientos para guantes o servilletas;
n. 1 alojamiento para mascarillas; n. 1 alojamiento para mordazas o cánulas; n. 2 porta rollo para papel y capas.

VELA

LOOK

LIKE

ALA / QUADRO
NOVO / UPRIGHT

MOVINGTRAY
MOVING ARM

PURA
PURASTUDIO

STERIL K

CART

ARMADI

BACINELLE

PIANI
ALZATINE

LAVELLI
RUBINETTI





LAVORAZIONI
ACCESSORI

OPEN BOX
SEGGIOLINI

PROF

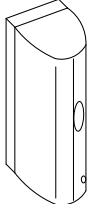
MAESTRO

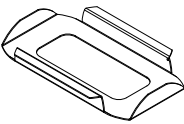
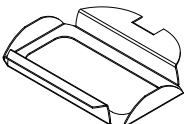
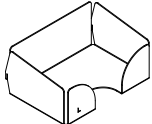
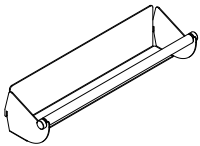
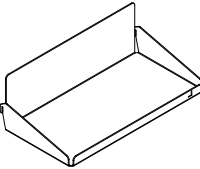
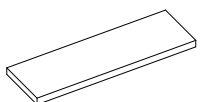
IMPIANTISTICA

	Descrizione / Description Description / Beschreibung / Descripción	Dim. Dim. / Dim. Maß / Dim. mm	M³ Kg	Articolo Item / Article Artikel / Artículo	Prezzo Price / Prix Preis / Precio
	DISTRIBUTORE DI SAPONE Soap dispenser Distributeur de savon Seifenspender Dispensador de jabón L 145	Manuale Manual	- 1,2	DSM	€ 107,00
		Con fotocellula Photocell-controlled Avec cellule photoélectrique Mit fotozelle Con fotocélula	- 1,2	DSF	€ 160,00
	DISTRIBUTORE DI BICCHIERI INFRATRONIC Infratronic cup dispenser Distributeur de gobelets Infratronic Infratronic becherspender Dispensador de vasos Infratronic	L 100 x H 310 P 110	- 0,3	DIS03	€ 85,00
	ALLOGGIAMENTO per guanti o salviette SPACE for gloves and serviettes LOGEMENT pour gants ou serviettes STECKPLATZ für Handschuhe oder Tücher ALOJAMIENTO para guantes o servilletas	L 254 x P 133	- 0,6	ALAPG	€ 62,00
	ALLOGGIAMENTO per mascherine PLACE for face masks LOGEMENT pour masques STECKPLATZ für Masken ALOJAMIENTO para mascarillas	L 188 x P 133	- 0,5	ALAPM	€ 62,00
	ALLOGGIAMENTO per bavagli o canule PALCE for bibs and cannulas LOGEMENT pour bavoires ou canules STECKPLATZ für Lätzchen oder Kanülen ALOJAMIENTO para mordazas o cánulas	L 185 x P 125	- 0,9	ALAPT	€ 62,00
	PORTAROTOLO per carta o mantelline Paper roll and cape CARRIER SUPPORT DE ROULEAU pour papier et capes PAPIERROLLENTRÄGER und Schulterumhänge PORTA ROLLO para papel y capas	L 322	- 0,7	ALAPR	€ 62,00
	MENSOLA Shelf Etagère Regal Repisa	L 250	-0,8	ALAME25	€ 62,00
		L 500	-1,6	ALAME50	€ 92,00
		L 905		ALAME905	€ 122,00
		L 1405		ALAME1405	€ 184,00
	FONDO Bottom Fond Unterseite Parte inferior	L 1030	-0,8	ALAF10	€ 122,00
		L 1530	-1,6	ALAF15	€ 184,00
	LAMPADA A LED LED lamp Lampe àLEDs LED-Leuchte Lâmpara de LED	L = 1030	- -	LED10	€ 173,00
		L = 1530	- -	LED15	€ 209,00

VELA
LOOK
LIKE
ALA / QUADRO NOVO / UPRIGHT
MOVINGTRAY
MOVING ARM
PURA
PURASTUDIO
STERIL K
CART
ARMADI
BACINELLE
PIANI
ALZATINE
LAVELLI
RUBINETTI
LAVORAZIONI
ACCESSORI
OPEN BOX
SEGGIOLINI
PROF
MAESTRO
IMPIANTISTICA

QUADRO | Pensile

Wall cabinet / Elément mural / Hängeschrank / Elemento colgante

LORAN

Descrizione / Description
Description / Beschreibung / Descripción

M³
Kg

Articolo
Item / Article
Artikel / Artículo

Prezzo
Price / Prix
Preis / Precio



L500 x H520 x P160 mm

Pensile completo di:

2 alloggiamenti per guanti o salviette; 1 vano per stoccaggio; 1 alloggiamento per bavagli o cannule; 1 alloggiamento per mascherine; 1 distributore di bicchieri **Infratronic**; 1 distributore di sapone automatico con fotocellula.

Wall cabinet equipped with:

2 gloves or towels holder; 1 storage compartment; 1 aprons or aspirator tips holder; 1 masks holder; 1 **Infratronic** cups dispenser; 1 touchless soap dispenser.

Meuble d'hygiène, fourni avec:

2 supports pour gants ou serviettes; 1 compartiment de stockage; 1 support pour canules; 1 support pour masques; 1 distributeur de gobelets **Infratronic**; 1 distributeur de savon à photocellule.

Spenderoberschrank, ausgestattet mit:

2 Spender für Handschuhe oder Handtücher; 1 Ablagefach; 1 Spender für Patientenumhänge oder Absaugkanülen; 1 Spender für Mundschutz; 1 **Infratronic** Becherspender; 1 Sensorspender für Seife.

Mueble colgante dotado de:

2 compartimentos para guantes o toallitas; 1 compartimento para almacenamiento; 1 compartimento para baberos o cánulas; 1 compartimento para máscaras; 1 dispensador de vasos **Infratronic**; 1 dispensador automático de jabón con fotocélula.

QUADRO € 694,00

VELA

LOOK

LIKE

ALA / QUADRO
NOVO / UPRIGHT

MOVINGTRAY
MOVING ARM

PURA
PURASTUDIO

STERIL K

CART

ARMADI

BACINELLE

PIANI
ALZATINE

LAVELLI
RUBINETTI

LAVORAZIONI
ACCESSORI

OPEN BOX
SEGGIOLINI

PROF

MAESTRO

IMPIANTISTICA

Descrizione / Description
Description / Beschreibung / Descripción

M³
Kg

Articolo
Item / Article
Artikel / Artículo

Prezzo
Price / Prix
Preis / Precio



L 620 x H 810 P 163

GRUPPO IGIENE IN CORIAN COMPLETO DI:

1 distributore di bicchieri **Infratronic**; 1 distributore di sapone automatico con fotocellula;
2 alloggiamenti per guanti o salviette; 1 alloggiamento per mascherine;
1 alloggiamento per bavagli o canule; 1 vano per stoccaggio.

CORIAN HYGIENE UNIT SUPPLIED WITH:

1 **Infratronic** glass dispenser; 1 soap dispenser with photocell;
2 compartments for gloves or tissues; 1 compartment for masks;
1 compartment for dental bibs or cannulas; 1 storage space.

GRUPE HYGIÈNE EN CORIAN ÉQUIPÉ DE:

1 distributeur de gobelets **Infratronic**; 1 distributeur automatique de savon avec cellule photoélectrique; 2 logements pour gants ou serviettes; 1 logement pour masques; 1 logement pour bavoires ou canules; 1 compartiment pour stockage.

HYGIENE-EINHEIT AUS CORIAN MIT:

1 **Infratronic** Becherspender; 1 automatische Seifenspender mit Fotozelle;
2 Fächern für Handschuhe oder Tücher; 1 Fach für Mundschutzmasken;
1 Fach für Patientenumhänge oder Speichelsauger; 1 Aufbewahrungsfach.

GRUPO DE HIGIENE DE CORIAN COMPUESTO POR:

1 dispensador de vasos **Infratronic**; 1 dispensador automático de jabón con fotocélula;
2 compartimentos para guantes o toallitas; 1 compartimento para máscaras;
1 compartimento para baberos o cánulas; 1 compartimento para almacenamiento.

Illuminazione Led - optional

Led Lighting – optional / Éclairage à Led – en option
LED-Beleuchtung - optional / Iluminación con leds - opcional

-
18 NOVO € 1.696,00

-
- NOVOLED € 173,00

VELA

LOOK

LIKE

ALA / QUADRO
NOVO / UPRIGHT

MOVINGTRAY
MOVING ARM

PURA
PURASTUDIO

STERIL K

CART

ARMADI

BACINELLE

PIANI
ALZATINE

LAVELLI
RUBINETTI



LAVORAZIONI
ACCESSORI

OPEN BOX
SEGGIOLINI

PROF

MAESTRO

IMPIANTISTICA

	Descrizione / Description Description / Beschreibung / Descripción	M ³ Kg	Articolo Item / Article Artikel / Artículo	Prezzo Price / Prix Preis / Precio
	<p>Lavello in Corian® a colonna versione a terra Corian® column sink, floor version Lavabo en Corian® sur colonne version sur pied Waschbecken aus Corian® mit Standsäule Lavabo de Corian® con columna en versión de pie</p> <p>Rubinetto escluso. Mixer excluded Robinet pas compris. Armaturo ist ausgeschlossen. Grifo excluido.</p>	- -	UP01	€ 2.237,00
L 410 x P 478 x H 890 mm				
	<p>Lavello in Corian® a colonna versione sospesa Corian® column sink, suspended version Lavabo en Corian® sur colonne version suspendue Waschbecken aus Corian® mit Halbsäule Lavabo de Corian® con columna en versión colgante</p> <p>Rubinetto escluso. Mixer excluded Robinet pas compris. Armaturo ist ausgeschlossen. Grifo excluido.</p>	- -	UP02	€ 2.350,00
L 410 x P 478 x H 790 mm				
	<p>Rubinetto a fotocellula con dispensatore di sapone integrato (Miscea) Photocell tap with integrated soap dispenser (Miscea) Robinet à cellule photoélectrique avec distributeur de savon intégré (Miscea) Fotozellenmischer mit integriertem Seifenspender (Miscea) Grifo con fotocélula y dispensador de jabón integrado (Miscea)</p> <p>Disponibile per la nostra gamma prodotti Available for our product range Disponible pour notre gamme de produits Für unsere Produktpalette erhältlich Disponibile para nuestra gama de productos</p>	- -		
L 410 x P 478 x H 890 mm				
	<p>Supporto Miscea per colonna UPRIGHT Miscea support for UPRIGHT column Support Miscea pour colonne UPRIGHT Miscea-Halterung für Säule UPRIGHT Soporte Miscea para columna UPRIGHT</p>	- 10	UP05	€ 94,00

KIT | MovingTray



MOVINGTRAY KIT
Piano in Corian, 520x400 mm, può ruotare a 360°
Braccio in alluminio anodizzato.

Corian® shelf, 520x400 mm
 Plan en Corian®, 520x400 mm
 Arbeitsplatte aus Corian®, 520x400 mm
 Estante de Corian®, 520x400 mm

€ 2.300,00

VELA | MovingTray



MODULO VELA con MovingTray e 3 cassetti: 1 A, 1 B e 1 C

Unit with 3 drawers: 1 A, 1 B and 1 C
 Module avec 3 tiroirs: 1 A, 1 B et 1 C
 Schrank mit 3 Schubladen: 1 A, 1 B und 1 C
 Módulo con 3 cajones: 1 A, 1 B y 1 C

Bacinelle / Trays / Intérieurs de tiroir
Einsätze / Bandejas:
2x VBA3, 2x VBB2, 2x VBC1

Maniglia
 Handle
 Poignée
 Griff
 Tirador

V3AMT € 3.866,00

L 1000 x P 505 mm

Push-Pull V3APT € 3.968,00



MODULO VELA con MovingTray e 6 cassetti: 2 A, 2 B e 2 C

Unit with 6 drawers: 2 A, 2 B and 2 C
 Module avec 6 tiroirs: 2 A, 2 B et 2 C
 Schrank mit 6 Schubladen: 2 A, 2 B und 2 C
 Módulo con 6 cajones: 2 A, 2 B y 2 C

Bacinelle / Trays / Intérieurs de tiroir
Einsätze / Bandejas:
2x VBA3, 2x VBB2, 2x VBC1



Maniglia
 Handle
 Poignée
 Griff
 Tirador

V6AMT € 4.070,00

L 1000 x P 505 mm

Push-Pull V6APT € 4.172,00

LOOK | MovingTray

 <p>L 1000 x P 445 mm</p>	<p>MODULO LOOK con MovingTray e 3 cassetti: 2 B e 1 C</p> <p>Unit with 3 drawers: 2 B and 1 C Module avec 3 tiroirs: 2 B et 1 C Schrank mit 3 Schubladen: 2 B und 1 C Módulo con 3 cajones: 2 B y 1 C</p> <p>Bacinelle / Trays / Intérieurs de tiroir Einsätze / Bandejas: 4x LBB2, 2x LBC1</p>	<p>Maniglia Handle Poignée Griff Tirador</p>	L3AMT	€	3.424,00
		<p>Push-Pull</p>	L3APT	€	3.525,00
 <p>L 1000 x P 445 mm</p>	<p>MODULO LOOK con MovingTray e 6 cassetti: 4 B e 2 C</p> <p>Unit with 6 drawers: 4 B and 2 C Module avec 6 tiroirs: 4 B et 2 C Schrank mit 6 Schubladen: 4 B und 2 C Módulo con 6 cajones: 4 B y 2 C</p> <p>Bacinelle / Trays / Intérieurs de tiroir Einsätze / Bandejas: 4x LBB2, 2x LBC1</p>	<p>Maniglia Handle Poignée Griff Tirador</p>	L6AMT	€	3.626,00
		<p>Push-Pull</p>	L6APT	€	3.727,00

PURA | MovingTray

 <p>L 1000 x P 505 mm</p>	<p>MODULO PURA con MovingTray e 4 cassetti: 1 A, 2 B e 1 C</p> <p>Unit with 4 drawers: 1 A, 2 B and 1 C Module avec 4 tiroirs: 1 A, 2 B et 1 C Schrank mit 4 Schubladen: 1 A, 2 B und 1 C Módulo con 4 cajones: 1 A, 2 B y 1 C</p> <p>Bacinelle / Trays / Intérieurs de tiroir Einsätze / Bandejas: 2x LBA3, 4x LBB2, 2x LBC1</p>	<p>Maniglia Handle Poignée Griff Tirador</p>	P4AMT	€	3.828,00
		<p>Push-Pull</p>	P4APT	€	3.929,00
 <p>L 1000 x P 505 mm</p>	<p>MODULO PURA con MovingTray e 8 cassetti: 2 A, 4 B e 2 C</p> <p>Unit with 8 drawers: 2 A, 4 B and 2 C Module avec 8 tiroirs: 2 A, 4 B et 2 C Schrank mit 8 Schubladen: 2 A, 4 B und 2 C Módulo con 8 cajones: 2 A, 4 B y 2 C</p> <p>Bacinelle / Trays / Intérieurs de tiroir Einsätze / Bandejas: 2x LBA3, 4x LBB2, 2x LBC1</p>	<p>Maniglia Handle Poignée Griff Tirador</p>	P8AMT	€	4.030,00
		<p>Push-Pull</p>	P8APT	€	4.131,00



Disponibile per mobili con supporto a pavimento o con supporto a muro. Non disponibile per mobili con basamento.

Available for furniture with floor-mounted support or wall-mounted support. Not available for furniture with a base.

Disponible pour les meubles avec support au sol ou support mural. Non disponible pour les meubles avec socle.

Disponible para muebles con soporte de suelo o con soporte mural. No disponible para muebles con zócalo.

Verfügbar für Möbel mit bodenstehender oder wandmontierter Ausführung. Nicht verfügbar für Möbel mit Sockel.

VELA | Moving Arm

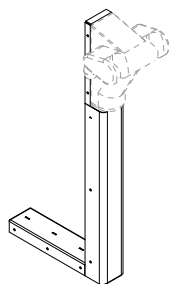

Moving Arm Vela

ARMV € 1.770,00

LOOK | Moving Arm

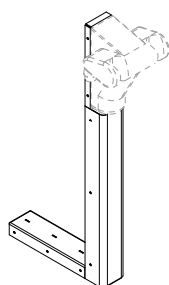

Moving Arm Look

ARMV € 1.770,00

PURA STUDIO | Moving Arm

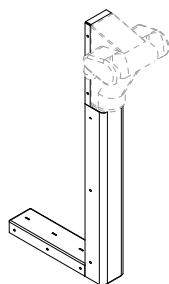

Moving Arm Pura

ARMP € 1.770,00

MODULI

Aggiungere ad ogni elemento il prezzo del supporto a pavimento o del basamento e relativi fianchi laterali dove necessari, del piano, dell'alzatina, del lavello e del rubinetto.

I moduli su misura possono essere realizzati solo con anta: applicare il prezzo dell'articolo di misura superiore con un supplemento del **25%**.

ATTENZIONE

Indicare sempre le misure delle apparecchiature che devono essere inserite nei moduli.

Le composizioni si intendono sempre a partire da sinistra verso destra. Specificare i colori di fianchi e frontali.

PER COLORI STANDARD SI INTENDE:

- Bianco Loran per i frontali, i fianchi di finitura e i basamenti
- Bianco Loran per il cassetto estraibile/frontale fisso sottopiano.

Specificare dimensioni e tipo di piano, alzatina, lavello e rubinetto.

Per composizioni con elementi ad angolo verificare la perpendicolarità delle pareti (90°): considerando la distanza di 80 cm su una parete e 60 cm sull'altra, la diagonale deve corrispondere a 100 cm.

Dimensioni: L = Larghezza P = Profondità H = Altezza

MANIGLIE ALLUMINIO

N.B.: solo in alluminio, **NO** verniciate.

SUPPORTI A PAVIMENTO

N.B.: piedi solo in alluminio, **NO** verniciati.

CORIAN®, STRATIFICATO E LAMINATO FENIX®: solo di colore bianco.

INOX AISI 304: satinato.

MAGGIORAZIONI DI PREZZO PER COLORAZIONI SPECIALI

- RAL standard:

Supplemento coppia fianchi di finitura	+ 110,00 €
Supplemento serie frontali/anta (ogni mobile)	+ 110,00 €
Basamento (ogni mobile)	+ 40,00 €
Frontale fisso/estraibile	+ 40,00 €
- RAL metallizzati/perlati e brillanti e in altri colori diversi dalla cartella RAL:

Supplemento coppia fianchi di finitura	+ 220,00 €
Supplemento serie frontali/anta (ogni mobile)	+ 220,00 €
Basamento (ogni mobile)	+ 80,00 €
Frontale fisso/estraibile	+ 80,00 €

SPESE IMBALLO: ogni collo € 20,00 prezzo netto.

UNITS

Add the price of the floor support or base, sides, top, splashback, sink and mixer to each unit.

Made-to-measure units: apply the price of the item with the next greater size and add a **25%** extra charge.

ATTENTION

Always provide the dimensions of the appliances that will be inserted into the units.

The compositions are always understood as starting from the left to the right. Specify the colors of the sides and fronts.

STANDARD COLORS:

- Bianco Loran / White Loran for sides and fronts, sides and bases.
- Bianco Loran / White Loran for the undercounter pull-out drawer /fixed front.

Specify the dimensions and type of top, splashback, sink and mixer.

Straight compositions with technical raceway and sink: use tops with minimum depth 520 mm.

For compositions with corner elements check that the walls are perfectly perpendicular (90°): considering the distance of 80 cm on the right and 60 cm left hand sides of the corner, the diagonal line must be 100 cm.

Dimensions:

L = Width P = Depth H = Height

ALUMINIUM HANDLE

Attention: only aluminium, **NOT** painted.

FLOOR SUPPORT

Attention: only aluminium feet, **NOT** painted.

CORIAN®, STRATIFIED and LAMINATE FENIX®: only in white color.

INOX AISI 304: satin finish.

UPCHARGES FOR SPECIAL COLORS

- Standard RAL:

Sides (2x): upcharge	+ 110,00 €
Fronts/door: upcharge for each unit	+ 110,00 €
Base: upcharge for each unit	+ 40,00 €
Fixed/pull-out front	+ 40,00 €
- Metallized/pearl and luminous RAL colors and other different colors from the RAL colors:

Sides (2x): upcharge	+ 220,00 €
Fronts/door: upcharge for each unit	+ 220,00 €
Base: upcharge for each unit	+ 80,00 €
Fixed/pull-out front	+ 80,00 €

PACKING COSTS:

each package € 20,00 net price.

Colori RAL consigliati per il cassetto estraibile / frontale fisso sottopiano

Recommended RAL colours for the removable drawer / under-counter fixed front item

Coloris RAL conseillés pour le tiroir extractible / façade fixe sous plan

Empfohlene RAL-Farben für ausziehbare Schublade / feststehende Front Unterbau

Colores RAL recomendados para el cajón extraíble / frente fijo de la pieza debajo de la encimera



RAL 1006
OPACO



RAL 3016
OPACO



RAL 6012
OPACO



BIANCO
LORAN

MODULES

À chaque module il faut ajouter le prix de: support au sol, base et cotés, plan, dossier, évier et robinet.

Les modules sur mesure peuvent être réalisés uniquement avec une porte: appliquer le prix de l'article de mesure supérieure et ajouter un supplément de 25%.

ATTENTION

Indiquer obligatoirement les mesures exactes des appareils destinés à être introduits dans les meubles.

Les compositions s'entendent toujours en partant de gauche vers la droite.

Spécifier les couleurs des panneaux latéraux et des façades.

COULEURS STANDARD:

- Blanc Loran pour les côtés, les façades et les bases.
- Blanc Loran pour le tiroir extractible/ façade fixe sous plan.

Spécifier les dimensions et le type du plan, du dossier, du lavabo et du robinet. Pour les compositions avec des éléments d'angle, contrôler soigneusement la perpendicularité des murs (90°): si on prend la distance exacte de 80 cm à droite et 60 cm à gauche de l'angle, la diagonale devra mesurer 100 cm.

Dimensions:

L = Largeur P = Profondeur H = Hauteur

POIGNÉE EN ALUMINIUM

Attention: en aluminium, PAS peintes.

SUPPORTS AU SOL

Attention: pieds en aluminium, PAS peints.

CORIAN®, STRATIFIE' et LAMINE' FENIX®: en couleur blanc seulement.

INOX AISI 304: satiné.

SUPPLÉMENTS DE PRIX POUR COULEURS SPÉCIALES

• RAL standard:

Côtés (2x) : supplément de prix + 110,00 €
Façades/porte: supplément de prix pour chaque module + 110,00 €
Base: supplément de prix pour chaque module + 40,00 €
Façade fixe/extractible supplément de prix +40,00 €

• Couleurs RAL métallisés/pearl et lumineux et d'autres couleurs différentes des couleurs RAL:

Côtés (2x) : supplément de prix + 220,00 €
Façades/porte: supplément de prix pour chaque module + 220,00 €
Base: supplément de prix pour chaque module + 80,00 €
Façade fixe/extractible: supplément de prix + 80,00 €

FRAIS D'EMBALLAGE:

prix net de chaque colis € 20,00.

SCHRÄNKE

Bei jedem Element muss der Preis des Bodengestells oder Sockels und, gegebenenfalls, der jeweiligen Seiten der Ebene, der Aufkantung, des Waschbeckens und des Wasserhahns separat berechnet werden.

Maßgefertigte Module können nur mit Tür hergestellt werden: auf den Preis des nächst größeren Artikels einen Mehrpreis von 25% berechnen.

VORSICHT

Immer die Maße der Geräte angeben, die in die Module eingebaut werden sollen.

Die Anbaulösungen sind immer von links nach rechts angegeben.

Die Farben der Seiten und Fronten angeben.

STANDARD FARBEN:

- Loran Weiss für Seiten, Fronten und Sockel.
- Loran Weiss für ausziehbare Schublade/ feststehende Front Unterbau.

Abmessungen und Art der Ebene, Aufkantung, Waschbecken und Wasserhahn angeben.

Bei Anbaulösungen mit Eckelementen lotrechte (90°) Wände kontrollieren: bei einem Abstand von 80 cm an einer Wand und 60 cm an der anderen von der Ecke muss die Diagonale 100 cm betragen.

Abmessungen: L = Breite P = Tief H = Höhe

ALUMINIUMGRIFF

Bitte beachten: Aluminium, NICHT lackiert.

BODENGESTELL

Bitte beachten: Aluminiumfüße, NICHT lackierte.

CORIAN®, SCHICHTSTOFF und LAMINAT FENIX®: nur weiß.

EDELSTAHL 304: satinert

AUFPREIS FÜR SONDERFARBEN

• Standard RAL:

Zierseiten (2x): Aufpreis + 110,00 €
Fronten/Tür: Aufpreis für jedes Möbelstück + 110,00 €
Sockel Aufpreis für jedes Möbelstück + 40,00 €
Feststehende/ausziehbare Front: Aufpreis: +40,00 €

• Metallic/Perl und leuchtende RAL-Farben und anderen verschiedenen Farben der RAL-Farben:

Zierseiten (2x) : Aufpreis + 220,00 €
Fronten/Tür: Aufpreis für jedes Möbelstück + 220,00 €
Sockel: Aufpreis für jedes Möbelstück + 80,00 €
Feststehende/ausziehbare Front: Aufpreis: +80,00 €

VERPACKUNGSKOSTEN:

jedes Paket € 20,00 Nettopreis.

MÓDULOS

Añadir a cada elemento el precio del soporte de pie, o de la base y de los paneles laterales, de la encimera, de la alzada, del lavabo y del grifo.

Los muebles a medida pueden realizarse sólo con la puerta: aplicar el precio del artículo de medida superior con un recargo del 25%.

ATENCIÓN

Indicar siempre las medidas de los equipos que deben introducirse en los módulos.

Las composiciones se consideran siempre a partir de la izquierda hacia la derecha.

Especificar los colores de los paneles laterales y de los frentes.

COLORES ESTANDAR:

- Blanco Loran para los paneles laterales, los frentes y las bases.
- Blanco Loran para el cajón extraíble/ frente fijo de la pieza debajo de la encimera.

Especificar las dimensiones y el tipo de encimera, de alzada, de lavabo y de grifo.

Para composiciones con elementos en ángulo controlar la perpendicularidad de las paredes (90°): considerando la distancia de 80 cm a la dcha. y 60 cm a la izq. del ángulo, la diagonal debe corresponder a 100 cm.

Dimensiones:

L = Ancho P = Profundidad H = Alto

TIRADOR DE ALUMINIO

Atención: en aluminio, NO pinta.

SOPORTE DE PIE

Atención: patas en aluminio, NO pintadas.

CORIAN®, ESTRATIFICADO y LAMINADO FENIX®: de color blanco.

INOX AISI 304: satinado.

CARGOS ADICIONAL PARA COLORACIONES ESPECIALES

• RAL standar:

Laterales (2x): cargo adicional + € 110,00
Frentes/puerta: cargo adicional por cada módulo + € 110,00
Base: cargo adicional por cada módulo + € 40,00

• Frente fijo/extraíble + € 40,00

• RAL metalizados/perla y brillantes y otros colores diferentes de colores RAL:

Laterales (2x): cargo adicional + € 220,00
Frentes/puerta: cargo adicional por cada módulo + € 220,00
Base: cargo adicional por cada módulo + € 80,00
Frente fijo/extraíble + € 80,00

EMBALAJE:

cada paquete € 20,00 precio neto.

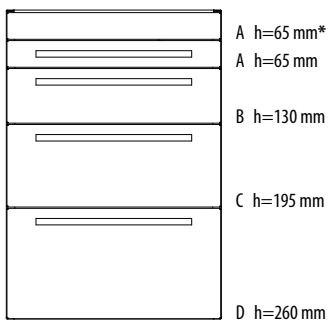
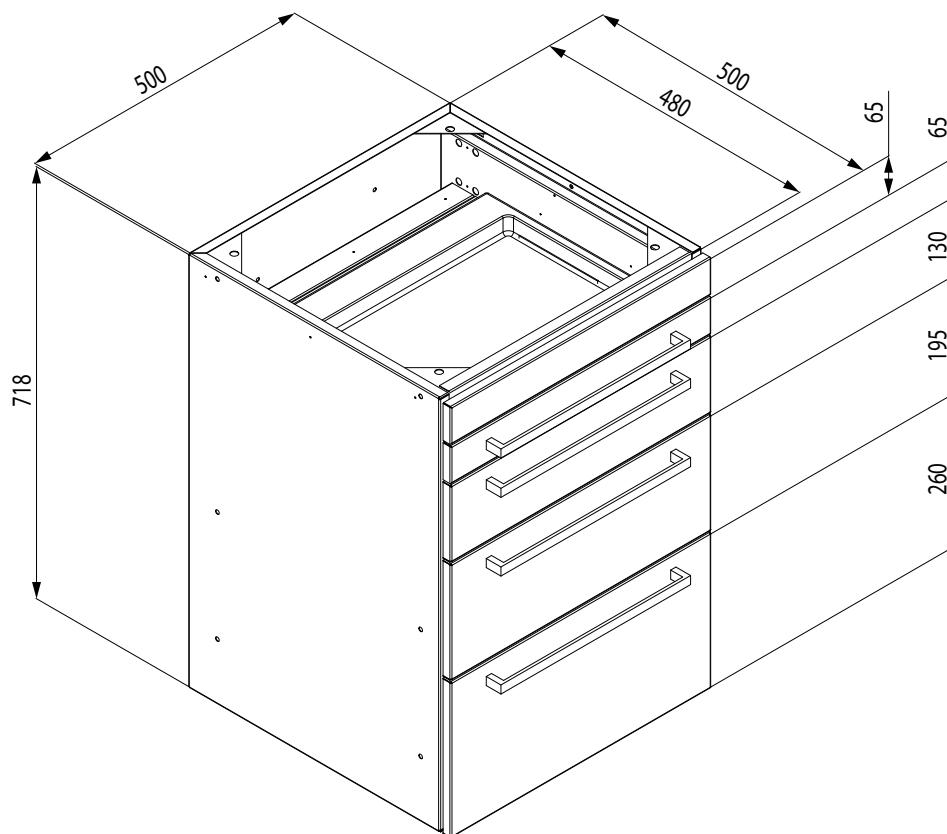

Cassetti
Drawers / Tiroirs
Schubladen / Cajones

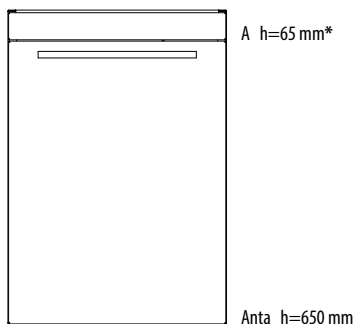

Anta
Door / Porte
Tür / Puerta

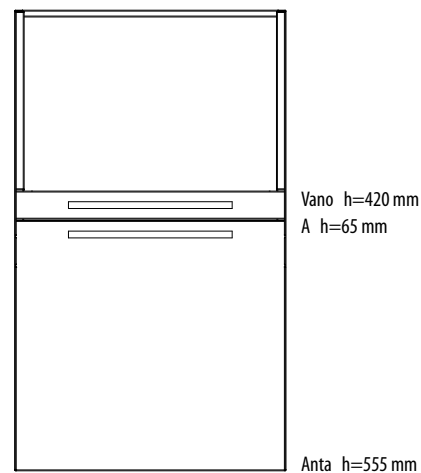

Modulo per termosigilatrice
Lowered module for autoclave
Module surbaissé pour autoclave
Gesenktes Modul für Autoklav
Módulo bajo para autoclave

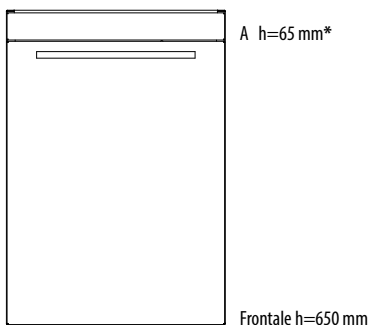

Cassettone
Pullout drawer / Grand tiroir
Oder schublade / Cajon

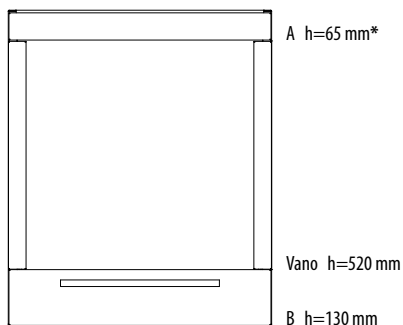

Modulo per autoclave
Module for autoclave / Module pour autoclave
Modul für Autoklav / Módulo para autoclave

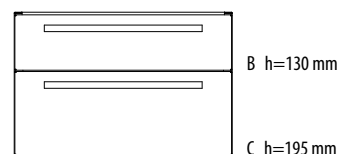

Modulo per termosigilatrice
Module for thermosigilator / Module pour thermoscellieuse / Modul für Wärmeversiegelung / Módulo para termoselladora

* Frontale A fisso (possibilità di sostituzione con cassetto estraibile) / Fixed A front panel (possibility of replacement with pull-out shelf) / Façade A fixe (possibilité de la remplacer par un tiroir extractible) / Feststehende Frontseite A (austauschbar mit ausziehbarer Schublade) / Frente A fijo (posibilidad de sustitución con cajón extraíble)

VELA
LOOK
LIKE
ALA / QUADRO NOVO / UPRIGHT
MOVINGTRAY MOVING ARM
PURA PURASTUDIO
STERIL K
CART
ARMADI
BACINELLE
PIANI ALZATINE
LAVELLI RUBINETTI
LAVORAZIONI ACCESSORI
OPEN BOX SEGGIOLINI
PROF
MAESTRO
IMPIANTISTICA

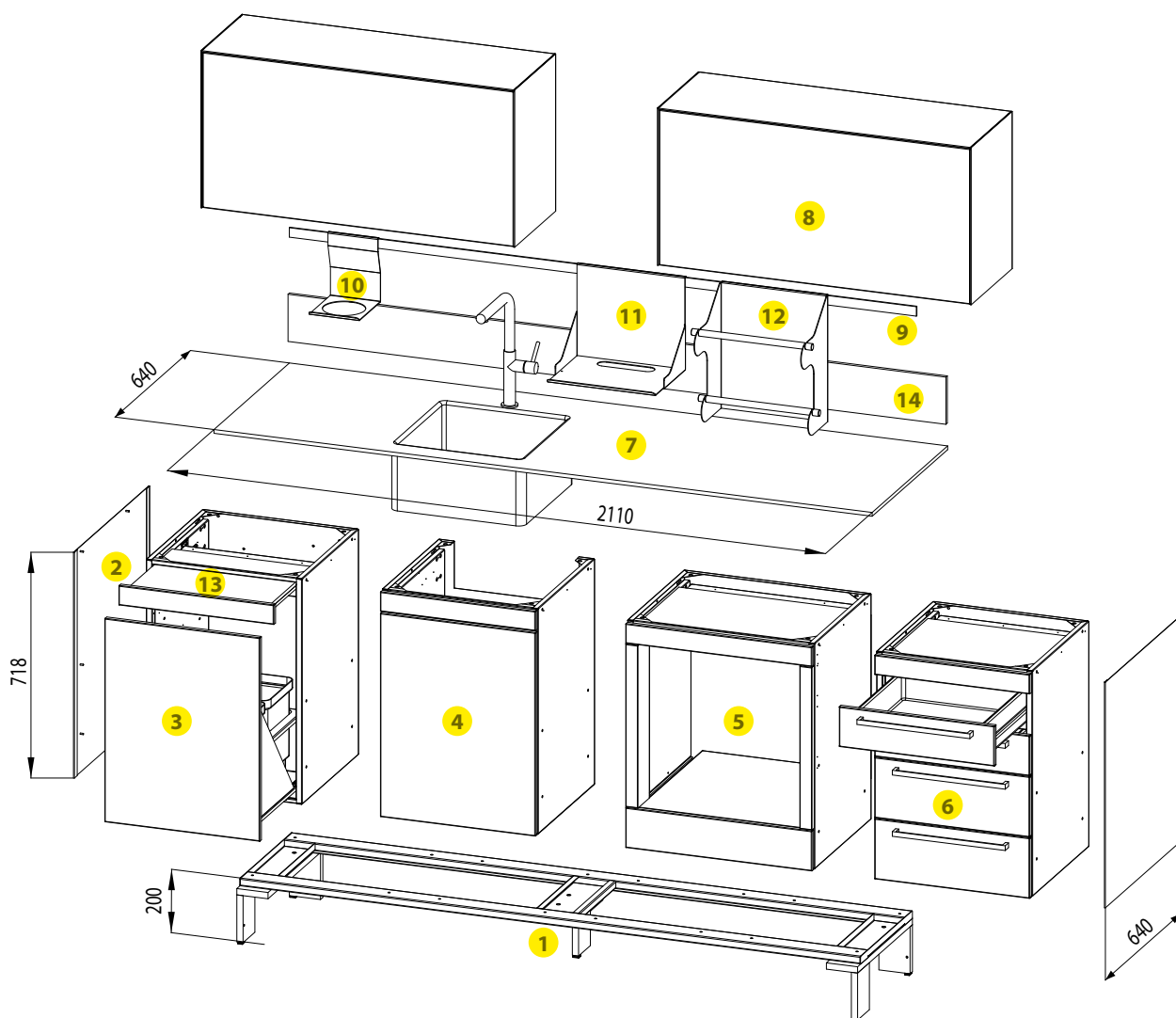

MOBILE PURA

1 - Supporto a pavimento; 2 - Fianco laterale; 3 - Mobile con cassettone estraibile; 4 - Mobile lavello; 5 - Mobile porta autoclave; 6 - Mobile con 4 cassetti: 2 B e 2 C; 7 - Piano con lavello; 8 - Pensile; 9 - Barra attrezzata; 10 - Supporto contenitore aghi; 11 - Supporto attrezzatura; 12 - Portarotolo da esterno; 13 - Ripiano estraibile; 14 - Alzatina.

UNIT PURA

1 - Floor support; 2 - Lateral side; 3 - Module with large pull-out drawer; 4 - Sink unit; 5 - Module for autoclave; 6 - Unit with 4 drawers: 2 B and 2 C; 7 - Top with sink; 8 - Wall unit; 9 - Equipped bar; 10 - Support for needle container; 11 - Support for equipments; 12 - Roll holder for exterior; 13 - Pull-out shelf; 14 - Splashback.

MOBILIER PURA

1 - Support au sol; 2 - Panneau latéral; 3 - Module avec bac extractible; 4 - Module lavabo; 5 - Module pour autoclave; 6 - Module avec 4 tiroirs: 2 B + 2 C; 7 - Plan avec évier; 8 - Élément mural; 9 - Barre équipée; 10 - Support pour conteneur à aiguilles; 11 - Support pour équipements; 12 - Porte-rouleau extérieur; 13 - Tirette; 14 - Dossieret.

PURA-MÖBEL

1 - Bodengestell; 2 - Seitenwand; 3 - Modul mit ausziehbarer Schublade; 4 - Waschbeckenschrank; 5 - Modul für Autoklav; 6 - Schrank mit 4 Schubladen: 2 B + 2 C; 7 - Arbeitsplatte mit Waschbecken; 8 - Hängeschrank; 9 - Stangenausstattung; 10 - Halterung für Nadelbehälter; 11 - Halterung für Geräte; 12 - Rollenhalterung für außen; 13 - Ausziehbarer Einlegeboden; 14 - Aufkantung.

MUEBLE PURA

1 - Soporte de pie; 2 - Panel lateral; 3 - Módulo con cajón extraíble; 4 - Módulo bajo lavabo; 5 - Módulo para autoclave; 6 - Módulo con 4 cajones: 2 B + 2 C; 7 - Encimera con lavabo; 8 - Mueble colgante; 9 - Barra equipada; 10 - Soporte para contenedor agujas; 11 - Soporte para equipos; 12 - Porta-rollos para exterior; 13 - Estante extraíble; 14 - Alzada.

H Sottopiano: / H Under the top: / H Sous plan de travail: / H Unter der Arbeitsplatte: / A Bajo encimera: 920 mm

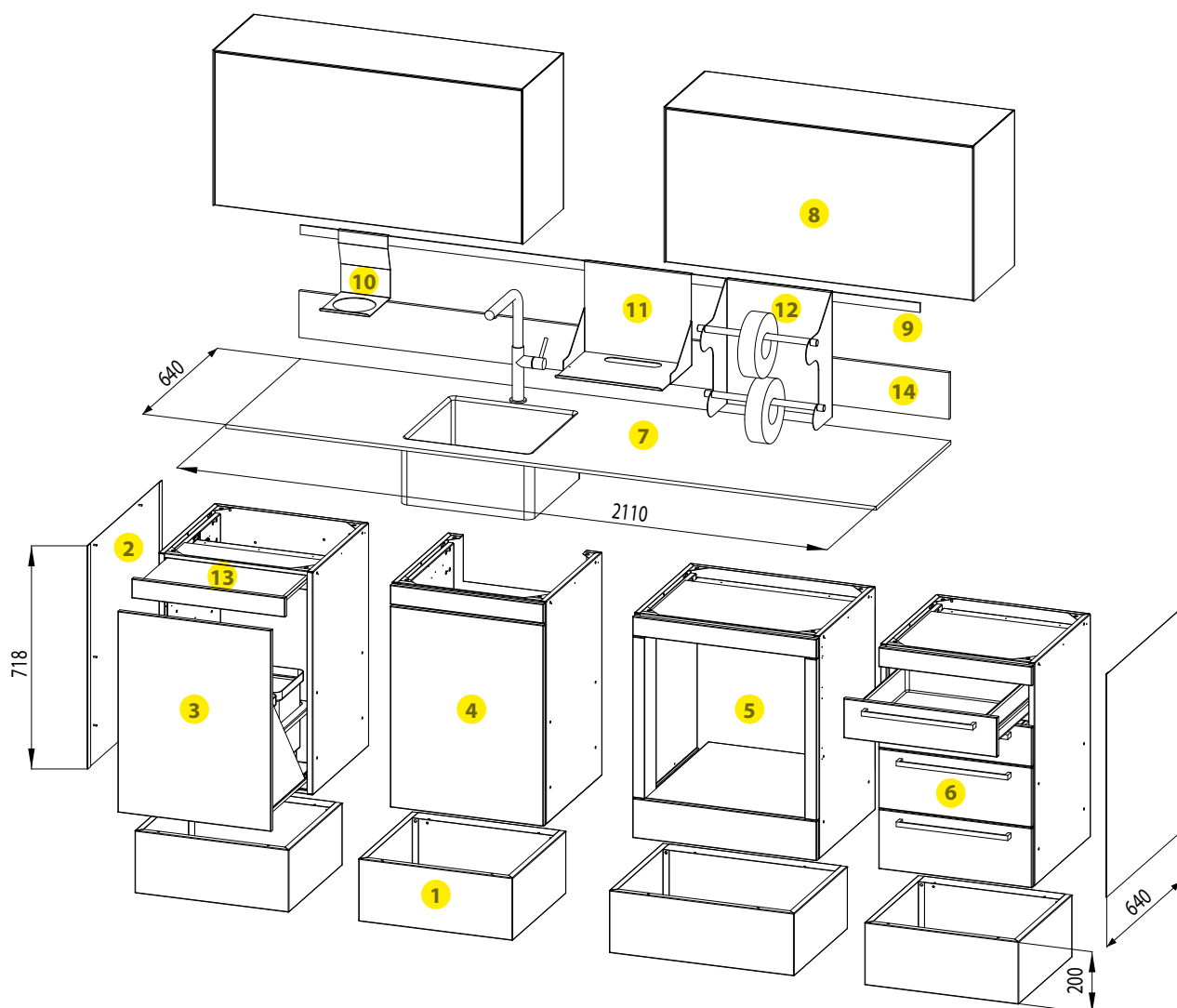

MOBILE PURA

1 - Basamento; 2 - Fianco laterale; 3 - Mobile con cassettone estraibile; 4 - Mobile lavello; 5 - Mobile porta autoclave; 6 - Mobile con 4 cassetti: 2 B e 2 C; 7 - Piano con lavello; 8 - Pensile; 9 - Barra attrezzata; 10 - Supporto contenitore aghi; 11 - Supporto attrezzatura; 12 - Portarotolo da esterno; 13 - Ripiano estraibile; 14 - Alzatina.

UNIT PURA

1 - Base unit; 2 - Lateral side; 3 - Module with large pull-out drawer; 4 - Sink unit; 5 - Module for autoclave; 6 - Unit with 4 drawers: 2 B and 2 C; 7 - Top with sink; 8 - Wall unit; 9 - Equipped bar; 10 - Support for needle container; 11 - Support for equipments; 12 - Roll holder for exterior; 13 - Pull-out shelf; 14 - Splashback.

MOBILIER PURA

1 - Base; 2 - Panneau latéral; 3 - Module avec bac extractible; 4 - Module lavabo; 5 - Module pour autoclave; 6 - Module avec 4 tiroirs: 2 B + 2 C; 7 - Plan avec évier; 8 - Élément mural; 9 - Barre équipée; 10 - Support pour conteneur à aiguilles; 11 - Support pour équipements; 12 - Porte-rouleau extérieur; 13 - Tirette; 14 - Dossret.

PURA-MÖBEL

1 - Sockel; 2 - Seitenwand; 3 - Modul mit ausziehbarer Schublade; 4 - Waschbeckenschrank; 5 - Modul für Autoklav; 6 - Schrank mit 4 Schubladen: 2 B + 2 C; 7 - Arbeitsplatte mit Waschbecken; 8 - Hängeschrank; 9 - Stangenausstattung; 10 - Halterung für Nadelbehälter; 11 - Halterung für Geräte; 12 - Rollenhalterung für außen; 13 - Ausziehbarer Einlegeboden; 14 - Aufkantung.

MUEBLE PURA

1 - Base; 2 - Panel lateral; 3 - Módulo con cajón extraíble; 4 - Módulo bajo lavabo; 5 - Módulo para autoclave; 6 - Módulo con 4 cajones: 2 B + 2 C; 7 - Encimera con lavabo; 8 - Mueble colgante; 9 - Barra equipada; 10 - Soporte para contenedor agujas; 11 - Soporte para equipos; 12 - Porta-rollos para exterior; 13 - Estante extraíble; 14 - Alzada.

H Sottopiano: / H Under the top: / H Sous plan de travail: / H Unter der Arbeitsplatte: / A Bajo encimera: 920 mm

VELA
LOOK
LIKE
ALA / QUADRO NOVO / UPRIGHT
MOVINGTRAY MOVING ARM
PURA PURASTUDIO
STERIL K
CART
ARMADI
BACINELLE
PIANI ALZATINE
LAVELLI RUBINETTI
LAVORAZIONI ACCESSORI
OPEN BOX SEGGIOLINI
PROF
MAESTRO
IMPIANTISTICA

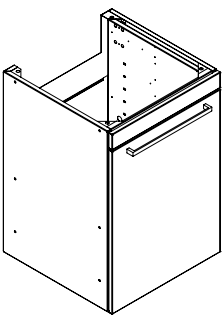
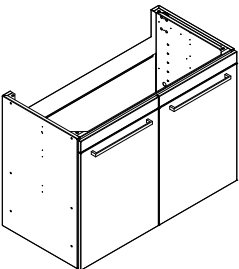
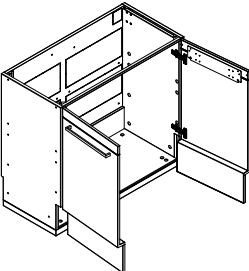
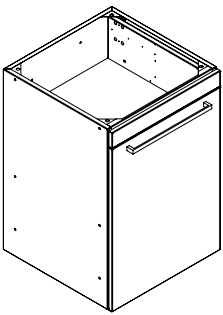
	Descrizione / Description Description / Beschreibung / Descripción	Apertura Opening / Ouverture Öffnung / Apertura	M ³ Kg	Articolo Item / Article Artikel / Artículo	Prezzo Price / Prix Preis / Precio
 <p>MODULO sottolavello con anta "PLA" o con cassettone estraibile "PLC", con portarifiuti interno</p> <p>Sink module with "PLA" door or "PLC" pullout drawer, with internal waste bin</p> <p>Module évier avec porte "PLA" ou avec bac extractible "PLC", avec poubelle intérieure</p> <p>Unterwaschbecken-Modul mit Tür "PLA" oder ausziehbarer Schublade "PLC", mit Innenabfallbehälter</p> <p>Módulo debajo del lavabo con hoja "PLA" o con cajón extraíble "PLC", con cubo de basura interior</p> <p>L 500 x P 500 x H 718 mm</p>		Maniglia Handle Poignée Griff Tirador	0,17 27,7	PLAM	€ 501,00
			0,17 32,2	PLCM	€ 614,00
			0,17 27,5	PLAP	€ 524,00
	Push-Pull		0,17 32	PLCP	€ 638,00
 <p>MODULO sottolavello L 1000 mm con 2 ante e portarifiuti interno</p> <p>Sink module sink L 1000 mm with 2 doors and internal waste bin</p> <p>Module évier L 1000 mm avec 2 portes et poubelle intérieure</p> <p>Unterwaschbecken-Modul L 1000 mm mit 2 Türen und Innenabfallbehälter</p> <p>Módulo debajo del lavabo L 1000 mm con 2 hojas y cubo de basura interior</p> <p>L 1000 x P 500 x H 718 mm</p>		Maniglia Handle Poignée Griff Tirador	0,36 48,4	PLLM	€ 986,00
	Push-Pull		0,36 48	PLLP	€ 1.069,00
 <p>MODULO L 1000 H.918 con 2 ante intere, per bidoni portarifiuti del cliente. (Luce interna utile H.850)</p> <p>Module for customer's waste bins (useful internal height 850 mm)</p> <p>Module pour poubelles du client (hauteur intérieure utile 850 mm)</p> <p>Modul für Kunden-Abfallbehälter (nutzbare Innenhöhe 850 mm)</p> <p>Módulo para contenedores de basura del cliente (altura interior útil 850 mm)</p> <p>L 1000 x P 426 x H 918 mm</p>		Maniglia Handle Poignée Griff Tirador	0,36 50	PPTM	€ 1.392,00
			0,17 26,5	PPAM (L. 500 mm)	€ 469,00
 <p>MODULO con anta e due ripiani interni</p> <p>Unit with door and 2 interior shelves</p> <p>Module avec porte et 2 étagères internes</p> <p>Schrank mit Tür und 2 Einlegeböden</p> <p>Módulo con puerta y dos estantes interiores</p> <p>L 500 x P 500 x H 718 mm L 600 x P 500 x H 718 mm</p>		Maniglia Handle Poignée Griff Tirador	0,22 30,5	PPMM (L. 600 mm)	€ 587,00
			0,17 26,3	PPAP (L. 500 mm)	€ 493,00
	Push-Pull		0,22 30,3	PPMP (L. 600 mm)	€ 610,00

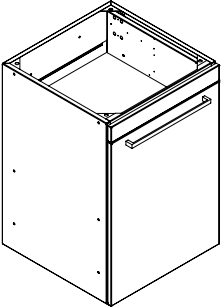
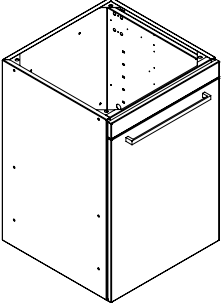
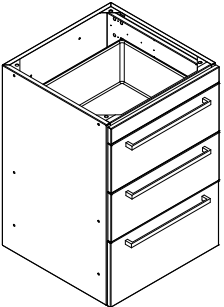
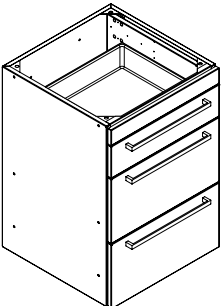
	Descrizione / Description Description / Beschreibung / Descripción	Apertura Opening / Ouverture Öffnung / Apertura	M³ Kg	Articolo Item / Article Artikel / Artículo	Prezzo Price / Prix Preis / Precio
 <p>MODULO schiena aperta, con anta e due ripiani interni</p> <p>Open back module, with door and two internal shelves</p> <p>Module ouvert derrière, avec porte et deux étagères intérieures</p> <p>Modul hinten offen, mit Tür und zwei Einlegeböden</p> <p>Módulo sin paneles, con hoja y dos estantes interiores</p> <p>L 500 x P 500 x H 718 mm L 600 x P 500 x H 718 mm</p>		Maniglia Handle Poignée Griff Tirador	0,17 24,3	PPFM (L. 500 mm)	€ 493,00
		Push-Pull	0,22 28,3	PPNM (L. 600 mm)	€ 610,00
			0,17 24,1	PPFP (L. 500 mm)	€ 516,00
			0,22 28,1	PPNP (L. 600 mm)	€ 634,00
 <p>MODULO con anta senza ripiani "PPI" o con cassettone estraibile con 2 portarifiuti "PPC"</p> <p>Module with "PPI" door without shelves or "PPC" large pull-out drawer with 2 waste bins</p> <p>Module avec porte "PPI" sans étagères ou avec bac extractible avec 2 poubelles "PPC"</p> <p>Modul mit Tür "PPI" ohne Einlegeböden "PPI" oder mit ausziehbarer Schublade mit 2 Abfallbehältern "PPC"</p> <p>Módulo con hoja sin estantes "PPI" o con cajón extraíble con 2 cubos de basura "PPC"</p> <p>L 500 x P 500 x H 718 mm</p>		Anta Door/Porte Tür/Puerta	0,17 26,5	PPIM	€ 394,00
			0,17 26,3	PPIP	€ 417,00
			0,17 39	PPCM	€ 732,00
		Cassettone Drawer/Tiroir Schublade Cajon	0,17 38,8	PPCP	€ 755,00
 <p>MODULO con 3 cassetti: 2 C e 1 D</p> <p>Unit with 3 drawers: 2 C and 1 D</p> <p>Module avec 3 tiroirs: 2 C et 1 D</p> <p>Schrank mit 3 Schubladen: 2 C et 1 D</p> <p>Módulo con 3 cajones: 2 C y 1 D</p> <p>Bacinelle / Trays / Intérieurs de tiroir Einsätze / Bandejas: 3xLBC1</p> <p>L 500 x P 500 x H 718 mm</p>		Maniglia Handle Poignée Griff Tirador	0,17 40	P3AM	€ 723,00
		Push-Pull	0,17 39,4	P3AP	€ 758,00
 <p>MODULO con 3 cassetti: 1 B e 2 D</p> <p>Unit with 3 drawers: 1 B and 2 D</p> <p>Module avec 3 tiroirs: 1 B et 2 D</p> <p>Schrank mit 3 Schubladen: 1 B et 2 D</p> <p>Módulo con 3 cajones: 1 B y 2 D</p> <p>Bacinelle / Trays / Intérieurs de tiroir Einsätze / Bandejas: 1xLBB1, 2xLBC1</p> <p>L 500 x P 500 x H 718 mm</p>		Maniglia Handle Poignée Griff Tirador	0,17 40,2	P3BM	€ 746,00
		Push-Pull	0,17 40	P3BP	€ 782,00

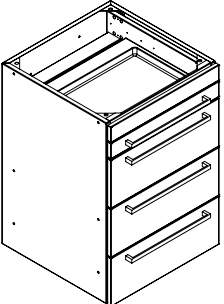
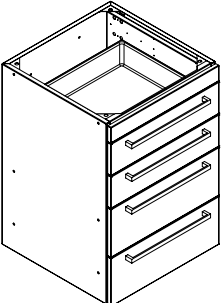
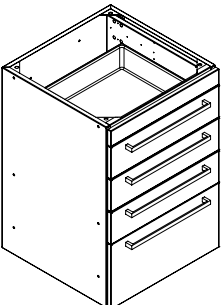
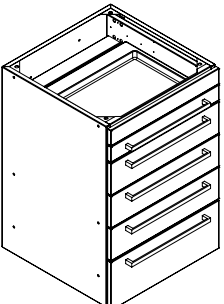
	Descrizione / Description Description / Beschreibung / Descripción	Apertura Opening / Ouverture Öffnung / Apertura	M ³ Kg	Articolo Item / Article Artikel / Artículo	Prezzo Price / Prix Preis / Precio
 <p>MODULO con 4 cassetti: 1 A e 3 C Unit with 4 drawers: 1 A and 3 C Module avec 4 tiroirs: 1 A et 3 C Schrank mit 4 Schubladen: 1 A et 3 C Módulo con 4 cajones: 1 A y 3 C</p> <p>Bacinelle / Trays / Intérieurs de tiroir Einsätze / Bandejas: 1xLBA2, 3xLBC1</p> <p>L 500 x P 500 x H 718 mm</p>		Maniglia Handle Poignée Griff Tirador	0,17 43,7	P4AM	€ 809,00
		Push-Pull	0,17 43,5	P4AP	€ 856,00
 <p>MODULO con 4 cassetti: 2 B e 2 C Unit with 4 drawers: 2 B and 2 C Module avec 4 tiroirs: 2 B et 2 C Schrank mit 4 Schubladen: 2 B et 2 C Módulo con 4 cajones: 2 B y 2 C</p> <p>Bacinelle / Trays / Intérieurs de tiroir Einsätze / Bandejas: 1xLBB1, 1xLBB2, 2xLBC1</p> <p>L 500 x P 500 x H 718 mm</p>		Maniglia Handle Poignée Griff Tirador	0,17 44,3	P4BM	€ 809,00
		Push-Pull	0,17 44,1	P4BP	€ 856,00
 <p>MODULO con 4 cassetti: 3 B e 1 D Unit with 4 drawers: 3 B and 1 D Module avec 4 tiroirs: 3 B et 1 D Schrank mit 4 Schubladen: 3 B et 1 D Módulo con 4 cajones: 3 B y 1 D</p> <p>Bacinelle / Trays / Intérieurs de tiroir Einsätze / Bandejas: 1xLBB1, 1xLBB2, 1xLBB3, 1xLBC1</p> <p>L 500 x P 500 x H 718 mm</p>		Maniglia Handle Poignée Griff Tirador	0,17 38,5	P4CM	€ 800,00
		Push-Pull	0,17 38,3	P4CP	€ 846,00
 <p>MODULO con 5 cassetti: 1 A, 3 B e 1 C Unit with 5 drawers: 1 A, 3 B and 1 C Module avec 5 tiroirs: 1 A, 3 B et 1 C Schrank mit 5 Schubladen: 1 A, 3 B et 1 C Módulo con 5 cajones: 1 A, 3 B y 1 C</p> <p>Bacinelle / Trays / Intérieurs de tiroir Einsätze / Bandejas: 1xLBA2, 1xLBB1, 1xLBB2, 1xLBB3, 1xLBC1</p> <p>L 500 x P 500 x H 718 mm</p>		Maniglia Handle Poignée Griff Tirador	0,17 48,2	P5AM	€ 889,00
		Push-Pull	0,17 48	P5AP	€ 946,00

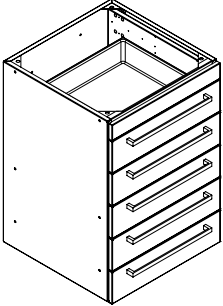
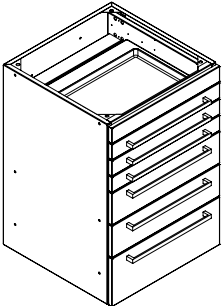
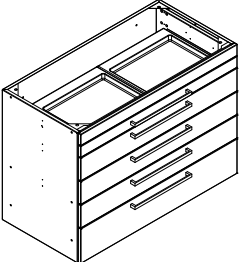
	Descrizione / Description Description / Beschreibung / Descripción	Apertura Opening / Ouverture Öffnung / Apertura	M ³ Kg	Articolo Item / Article Artikel / Artículo	Prezzo Price / Prix Preis / Precio
 <p>MODULO con 5 cassetti: 5 B Unit with 5 drawers: 5 B Module avec 5 tiroirs: 5 B Schrank mit 5 Schubladen: 5 B Módulo con 5 cajones: 5 B</p> <p>Bacinelle / Trays / Intérieurs de tiroir Einsätze / Bandejas: 3xLBB1, 1xLBB2, 1xLBB3</p> <p>L 500 x P 500 x H 718 mm</p>		Maniglia Handle Poignée Griff Tirador	0,17 48,9	P5BM	€ 889,00
		Push-Pull	0,17 48,7	P5BP	€ 946,00
 <p>MODULO con 6 cassetti: 3 A, 2 B e 1 C Unit with 6 drawers: 3 A, 2 B and 1 C Module avec 6 tiroirs: 3 A, 2 B et 1 C Schrank mit 6 Schubladen: 3 A, 2 B et 1 C Módulo con 6 cajones: 3 A, 2 B y 1 C</p> <p>Bacinelle / Trays / Intérieurs de tiroir Einsätze / Bandejas: 1xLBA1, 1xLBA2, 1xLBA3, 1xLBB1, 1xLBB3, 1xLBC1</p> <p>L 500 x P 500 x H 718 mm</p>		Maniglia Handle Poignée Griff Tirador	0,17 51,6	P6AM	€ 976,00
		Push-Pull	0,17 51,4	P6AP	€ 1.047,00
 <p>MODULO L 1000 mm con 5 cassetti: 1 A, 3 B e 1 C Unit L 1000 mm with 5 drawers: 1 A, 3 B and 1 C Module L 1000 mm avec 5 tiroirs: 1 A, 3 B et 1 C Schrank L 1000 mm mit 5 Schubladen: 1 A, 3 B und 1 C Módulo L 1000 mm con 5 cajones: 1 A, 3 B y 1 C</p> <p>Bacinelle / Trays / Intérieurs de tiroir Einsätze / Bandejas: 2xLBA2, 2xLBB1, 2xLBB2, 2xLBB3, 2xLBC1</p> <p>L 1000 x P 500 x H 718 mm</p>		Maniglia Handle Poignée Griff Tirador	0,36 82	P5AM2	€ 1.446,00
		Push-Pull	0,36 81	P5AP2	€ 1.566,00

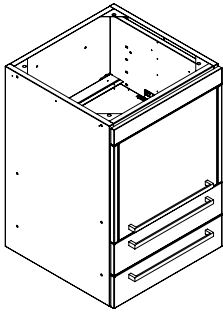
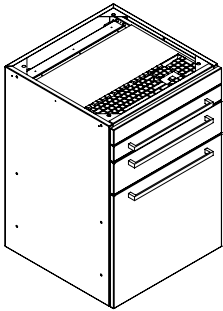
	Descrizione / Description Description / Beschreibung / Descripción	Apertura Opening / Ouverture Öffnung / Apertura	M ³ Kg	Articolo Item / Article Artikel / Artículo	Prezzo Price / Prix Preis / Precio
 <p>MODULO con anta a ribalta con 2 ripiani estraibili per apparecchiature + ciabatta con 3 prese di corrente e 2 cassetti B</p> <p>Unit with hide-away door equipped with 2 apparatus storage shelves + 3 Schuko sockets and 2 drawers B</p> <p>Module avec porte basculante avec 2 tirettes pour appareils + 3 prises de courant Schuko et 2 tiroirs B</p> <p>Schrank mit versenkbarer Tür mit 2 Geräteeinlagen + 3 Schuko-Steckdosen und 2 Schubladen B</p> <p>Módulo con puerta plegable con 2 estantes extraíbles para equipos + regleta con 3 tomas de corriente Schuko y 2 cajónes B</p> <p>Bacinnelle / Trays / Intérieurs de tiroir Einsätze / Bandejas: 1xLBB1, 1xLBB2</p> <p>L 500 x P 500 x H 718 mm</p>	<p>Maniglia Handle Poignée Griff Tirador</p>	<p>0,17 ----- 37</p>	PRAM	€ 1.345,00	
	<p>Push-Pull</p>	<p>0,17 ----- 36,4</p>	PRAP	€ 1.393,00	
 <p>MODULO PC con cassetto A per tastiera (L 385 - H 25 mm max) al posto del frontale fisso, 1 cassetto A e 1 B, anta e schiena aperta</p> <p>PC module with A drawer for keyboard (L 385 - H 25 mm max), instead of the fixed side, 1 drawer A and 1 B, door and open back</p> <p>Module PC avec tiroir A pour clavier (L 385 - H 25 mm max), à la place de la façade fixe, 1 tiroir A et 1 B, porte et dossier ouvert</p> <p>PC-modul mit Schublade A für Tastatur (L 385 - H 25 mm max), anstelle der feststehenden Frontseite, 1 Schublade A und 1 B, Tür und Rückseite offen</p> <p>Módulo PC con cajón A para teclado (L 385 - H 25 mm máx), en lugar del frontal fijo, 1 cajón A y 1 B, hoja y abierto en la parte trasera</p> <p>Bacinnelle / Trays / Intérieurs de tiroir Einsätze / Bandejas: 1xLBA2, 1xLBB1</p> <p>L 500 x P 500 x H 718 mm</p>	<p>Maniglia Handle Poignée Griff Tirador</p>	<p>0,17 ----- 42</p>	PPSM	€ 1.030,00	
	<p>Push-Pull</p>	<p>0,17 ----- 41,4</p>	PPSP	€ 1.077,00	

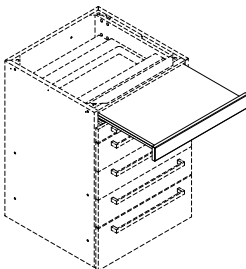
	Descrizione / Description Description / Beschreibung / Descripción	Apertura Opening / Ouverture Öffnung / Apertura	M ³ Kg	Articolo Item / Article Artikel / Artículo	Prezzo Price / Prix Preis / Precio
 <p>Supplemento per ripiano estraibile Push-Pull in Stratificato o Corian®</p> <p>Upcharge for Push-Pull shelf in stratified laminate or Corian®</p> <p>Supplément pour tirette Push-Pull en stratifié ou en Corian®</p> <p>Zusatz für ausziehbaren Push-Pull-Einlegeboden aus Verbundmaterial oder Corian®</p> <p>Suplemento para estante extraíble push-pull de estratificado o corian®</p>	Stratificato Stratified / Stratifié Schichtstoff Estratificado	- 8,2	- 8,2	PES5 (L. 500 mm)	€ 248,00
	Corian®	- 8,7	- 8,7	PEC5 (L. 500 mm)	€ 278,00
	Stratificato Stratified / Stratifié Schichtstoff Estratificado	- 8,7	- 8,7	PES6 (L. 600 mm)	€ 289,00
	Corian®	- 9,2	- 9,2	PEC6 (L. 600 mm)	€ 319,00

L 500
L 600

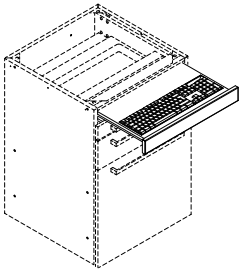
 <p>Supplemento per ripiano estraibile Push-Pull per tastiera (L 385 mm - H 25 mm max)</p> <p>Upcharge for removable Push-Pull drawer for keyboard (L 385 mm – H 25 mm max)</p> <p>Supplément pour tirette extractible Push-Pull pour clavier (L 385 mm - H 25 mm max.)</p> <p>Zusatz für ausziehbaren Push-Pull-Einlegeboden für Tastatur (L 385 mm - H 25 mm max)</p> <p>Suplemento para estante extraíble Push-Pull para teclado (L 385 mm - H 25 mm máx)</p>					
			- 8,2	PEK5 (L. 500 mm)	€ 248,00

L 500

 <p>MODULO da 1000 mm con 2 ante e 2 ripiani interni</p> <p>1000 mm module with 2 doors and 2 internal shelves</p> <p>Module de 1000 mm avec 2 portes et 2 étagères intérieures</p> <p>Modul 1000 mm, mit 2 Türen und 2 Inneneinlegeböden</p> <p>Módulo de 1000 mm con 2 hojas y 2 estantes interiores</p>	Maniglia Handle Poignée Griff Tirador		0,36 46	PPLM	€ 818,00
	Push-Pull		0,36 45,6	PPLP	€ 867,00

L 1000 x P 500 x H 718 mm

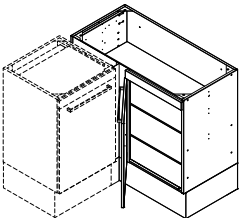
 <p>MODULO angolare con 2 ripiani interni</p> <p>Angular module with 2 internal shelves</p> <p>Module d'angle avec 2 étagères intérieures</p> <p>Eckmodul mit 2 Inneneinlegeböden</p> <p>Módulo angular con 2 estantes internos</p>	Maniglia Handle Poignée Griff Tirador		0,36 40	PPOM (Door on the right)	€ 818,00
			0,36 40	PPRM (Door on the left)	€ 818,00
	Push-Pull		0,36 39,8	PPOP (Door on the right)	€ 841,00
			0,36 39,8	PPRP (Door on the left)	€ 841,00

L 1000 x P 500 x H 718 mm

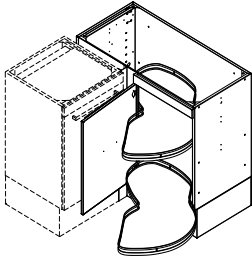
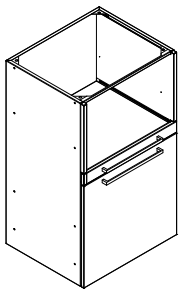
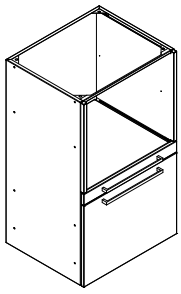
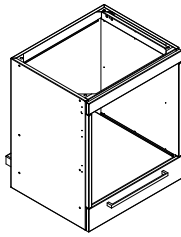
	Descrizione / Description Description / Beschreibung / Descripción	Apertura Opening / Ouverture Öffnung / Apertura	M³ Kg	Articolo Item / Article Artikel / Artículo	Prezzo Price / Prix Preis / Precio
 <p>MODULO angolare con 2 ripiani estraibili (portata max 40 kg a ripiano) Corner module with 2 pull-out shelves Module d'angle avec 2 tirettes Eckmodul mit 2 ausziehbaren Ebenen Módulo angular con 2 estantes extraíbles</p> <p>L 1000 x P 500 x H 718 mm</p>		Maniglia Handle Poignée Griff Tirador	0,36 57	PPJM (Door on the right)	€ 1.529,00
			0,36 57	PPKM (Door on the left)	€ 1.529,00
			0,36 56,8	PPJP (Door on the right)	€ 1.552,00
		Push-Pull	0,36 56,8	PPKP (Door on the left)	€ 1.552,00
 <p>MODULO per termosigilatrice con anta e predisposizione per autoclave sopra il piano (piano escluso) Module for thermosigilator with door and for autoclave arrangement under the surface (surface excluded) Module pour thermoscelleuse avec porte et pré-équipement pour autoclave sur le plan (plan non compris) Modul für Wärmeversiegelung mit Tür und Vorrichtung für Autoklav auf der Ebene (Ebene nicht inkl.) Módulo para termoselladora con hoja y predisposición para autoclave sobre la encimera (encimera no incluida)</p> <p>L 600 x P 500 x H 1065 mm</p>		Maniglia Handle Poignée Griff Tirador	0,3 38	PTAM	€ 882,00
		Push-Pull	0,3 37,6	PTAP	€ 906,00
 <p>MODULO per autoclave con vano H 520 e anta nella parte inferiore MODULE for autoclave with H 520 compartment and door in the lower part MODULE pour autoclave avec logement H 520 et porte dans la partie inférieure MODUL für Autoklav mit Fach H 520 und Tür im unteren Teil MÓDULO para autoclave con compartimento H 520 y puerta en la parte inferior</p> <p>L 600 x P 500 x H 1065 mm</p>		Maniglia Handle Poignée Griff Tirador	0,3 38	PAFM	€ 882,00
		Push-Pull	0,3 37,6	PAFP	€ 906,00
 <p>MODULO per autoclave Module for autoclave Module pour autoclave Modul für Autoklav Módulo para autoclave</p> <p>L 600 x P 500 x H 718 mm</p>		Maniglia Handle Poignée Griff Tirador	0,21 23	PAAM	€ 733,00
		Senza maniglia Without handle Sans poignée Ohne griff Sin tirador	0,21 22,8	PAAP	€ 733,00

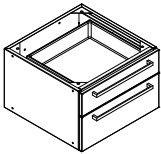
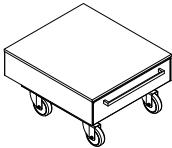
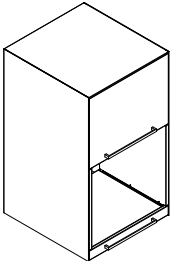
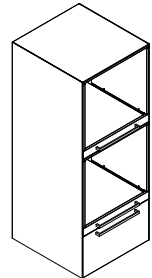
	Descrizione / Description Description / Beschreibung / Descripción	Apertura Opening / Ouverture Öffnung / Apertura	M ³ Kg	Articolo Item / Article Artikel / Artículo	Prezzo Price / Prix Preis / Precio
 <p>MODULO ribassato per autoclave o Multisteril con cassetti: 1 B e 1 C</p> <p>Lowered module for autoclave or Multisteril with drawers: 1 B and 1 C</p> <p>Module surbaissé pour autoclave ou multisteril avec tiroirs: 1 B et 1 C</p> <p>Gesenktes Modul für Autoklav oder Multisteril mit Schubladen: 1 B und 1 C</p> <p>Módulo bajo para autoclave o multisteril con cajones: 1 B y 1 C</p> <p>Bacinelle / Trays / Intérieurs de tiroir Einsätze / Bandejas: 1xLBB1, 1xLBC1</p> <p>L 500 x P 500 x H 328 mm</p>	<p>Maniglia Handle Poignée Griff Tirador</p> <p>0,8 18</p> <p>PABM</p> <p>€ 636,00</p>				
	<p>Push-Pull</p> <p>17,6</p> <p>PABP</p> <p>€ 660,00</p>				
 <p>CARRELLO porta autoclave con 1 cassetto B e piano in stratificato</p> <p>Autoclave-holder trolley with 1 B drawer and laminated top</p> <p>Chariot porte autoclave avec 1 tiroir B et un plan en stratifié</p> <p>Wagen für Autoklav mit 1 Schublade B und Ebene aus Verbundmaterial</p> <p>Carro porta autoclave con 1 cajón B y encimera de estratificado</p> <p>Bacinelle / Trays / Intérieurs de tiroir Einsätze / Bandejas: 1xLBA2</p> <p>L 510 x P 565 x H 310 mm</p>	<p>Maniglia Handle Poignée Griff Tirador</p> <p>0,1 26,1</p> <p>PACM</p> <p>€ 785,00</p>				
	<p>Push-Pull</p> <p>25,9</p> <p>PACP</p> <p>€ 797,00</p>				
 <p>Colonne complete di fianchi e copertura: con 1 vano per autoclave e anta, da posizionare soprapiano "PAD" o con 2 vani per autoclave e anta, da posizionare a terra "PAG"</p> <p>Columns complete with sides and cover: with 1 compartment for autoclave and door, to be positioned on the "PAD" top or with 2 compartments for autoclave and door, to be positioned on the "PAG" ground</p> <p>Colonnes munies de flancs et de couverture: avec 1 logement pour autoclave et porte, à positionner sur le plan de travail "PAD" ou avec 2 logements pour autoclave et porte, à positionner sur le sol "PAG"</p> <p>Säulen mit Seitenwänden und Abdeckung: mit 1 Fach für Autoklav und Türflügel, als Aufbaukonstruktion "PAD" oder mit 2 Fächern für Autoklav und Türflügel, zur Bodenplatzierung "PAG"</p> <p>Columnas con laterales y cobertura: con 1 compartimiento para autoclave y puerta, para colocar sobre la encimera "PAD" o con 2 compartimientos para autoclave y puerta, para colocar en el suelo "PAG"</p> <p>L 606 x P 640 x H 1068 mm</p>	<p>Maniglia Handle Poignée Griff Tirador</p> <p>0,3 40</p> <p>PADM</p> <p>€ 1.183,00</p>				
	<p>Push-Pull</p> <p>39,6</p> <p>PADP</p> <p>€ 1.207,00</p>				
 <p>L 606 x P 640 x H 1536 mm</p>	<p>Maniglia Handle Poignée Griff Tirador</p> <p>0,6 60</p> <p>PAGM</p> <p>€ 2.290,00</p>				
	<p>Push-Pull</p> <p>58,8</p> <p>PAGP</p> <p>€ 2.323,00</p>				

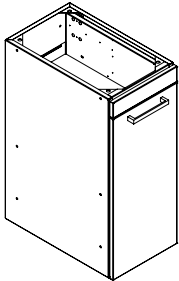
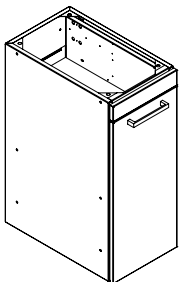
	Descrizione / Description Description / Beschreibung / Descripción	Apertura Opening / Ouverture Öffnung / Apertura	M³ Kg	Articolo Item / Article Artikel / Artículo	Prezzo Price / Prix Preis / Precio
 <p>MODULO con anta e due ripiani interni Unit with door and 2 interior shelves Module avec porte et 2 étagères internes Schrank mit Tür und 2 Einlegeböden Módulo con puerta y dos estantes interiores</p> <p>L 300 x P 500 x H 718 mm L 400 x P 500 x H 718 mm</p>		Maniglia Handle Poignée Griff Tirador	0,10 21,5	PPDM (L. 300 mm)	€ 469,00
			0,14 24	PPGM (L. 400 mm)	€ 469,00
		Push-Pull	0,10 21,4	PPDP (L. 300 mm)	€ 493,00
			0,14 23,9	PPGP (L. 400 mm)	€ 493,00
 <p>MODULO con anta e due ripiani interni, con schiena aperta Unit with door and 2 interior shelves, open back Module avec porte et 2 étagères internes, ouvert derrière Schrank mit Tür und 2 Einlegeböden, Rückwand geöffnet Módulo con puerta y dos estantes interiores, con panel trasero abierto</p> <p>L 300 x P 500 x H 718 mm L 400 x P 500 x H 718 mm</p>		Maniglia Handle Poignée Griff Tirador	0,10 21	PPEM (L. 300 mm)	€ 493,00
			0,14 23,5	PPHM (L. 400 mm)	€ 493,00
		Push-Pull	0,10 20,9	PPEP (L. 300 mm)	€ 516,00
			0,14 23,4	PPHP (L. 400 mm)	€ 516,00

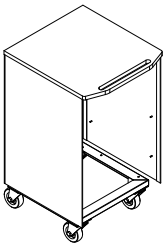
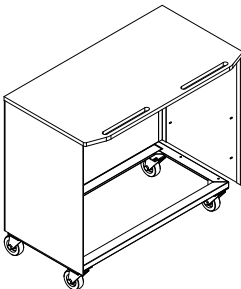
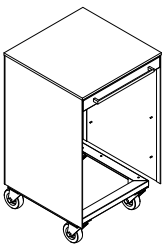
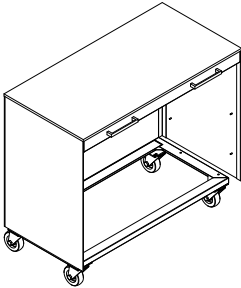
	Descrizione / Description Description / Beschreibung / Descripción	Piano Top / Plan Arbeitsplatte / Encimera	M³ Kg	Articolo Item / Article Artikel / Artículo	Prezzo Price / Prix Preis / Precio
 <p>L 510 x P 555 x H 900 mm</p>	<p>Kit ruote + piano sagomato Castor set + shaped top Kit roues + plan façonné Rollenset + geformtem Arbeitsplatte Kit de ruedas + encimera perfilada</p>	Corian®	0,25 ----- 31,5	KRPC	€ 549,00
		Stratificato Stratified / Stratifié Schichtstoff Estratificado	0,25 ----- 31	KRPS	€ 489,00
		Vetro Glass / Verre Glas / Vidrio	0,25 ----- 36	KRPV	€ 635,00
 <p>L 1010 x P 555 x H 900 mm</p>	<p>Kit ruote + piano sagomato L 1010 mm Castor set + shaped top 1010 mm Kit roues + plan façonné 1010 mm Rollenset + geformtem Arbeitsplatte 1010 mm Kit de ruedas + encimera perfilada 1010 mm</p>	Corian®	0,50 ----- 49	KRPC2	€ 826,00
		Stratificato Stratified / Stratifié Schichtstoff Estratificado	0,50 ----- 48	KRPS2	€ 765,00
		Vetro Glass / Verre Glas / Vidrio	0,50 ----- 58	KRPV2	€ 846,00
	MAGGIORAZIONI per piano in vetro Additional charge for glass top Supplément de prix pour plan en verre Aufpreis für Glasarbeitsplatte Cargo adicional para encimera de vidrio	Extra-chiaro / Extra clear / Transparent / Transparent / Transparente			€ +82,00
		Satinato / Satin / Dépoli / Satiniert / Satinado			€ +88,00
 <p>L 510 x P 555 x H 908 mm</p>	<p>Kit ruote + piano inox Castor set + shaped top Kit roues + plan façonné Rollenset + geformtem Arbeitsplatte Kit de ruedas + encimera perfilada</p>	Acciaio Inox Steel / Acier Stahl / Acero	0,25 ----- 32	KRPI	€ 619,00
 <p>L 1010 x P 555 x H 908 mm</p>	<p>Kit ruote + piano inox L 1010 mm Castor set + shaped top 1010 mm Kit roues + plan façonné 1010 mm Rollenset + geformtem Arbeitsplatte 1010 mm Kit de ruedas + encimera perfilada 1010 mm</p>	Acciaio Inox Steel / Acier Stahl / Acero	0,50 ----- 49	KRPI2	€ 1.034,00

PURA | Supporti a pavimento

Floor supports / Supports au sol / Bodengestelle / Soportes de pie

LORAN

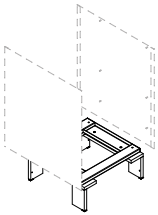
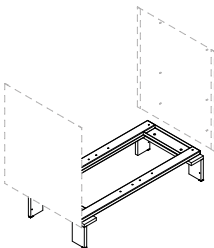
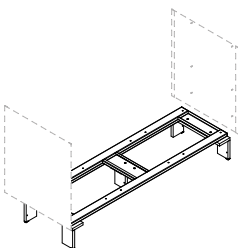
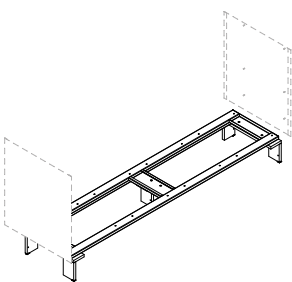
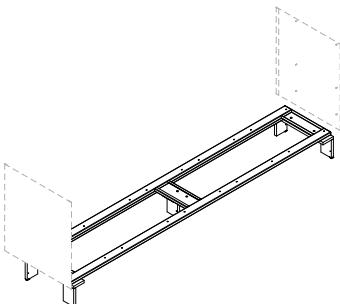
	Descrizione / Description Description / Beschreibung / Descripción	M ³ Kg	Articolo Item / Article Artikel / Artículo	Prezzo Price / Prix Preis / Precio
 <p>L 500 mm L 600 mm</p>	SUPPORTO a pavimento per 1 modulo Floor support for 1 unit Support au sol pour 1 module Bodengestell für 1 Schrank Soporte de pie para 1 módulo	0,30 12	PS05V (L. 510 mm)	€ 335,00
		0,36 13	PS06V (L. 610 mm)	€ 372,00
 <p>L 1000-1100 mm</p>	SUPPORTO a pavimento per 2 moduli Floor support for 2 units Support au sol pour 2 modules Bodengestell für 2 Schränke Soporte de pie para 2 módulos	0,59 15	PS10V (L. 1010 mm)	€ 385,00
		0,65 16	PS11V (L. 1110 mm)	€ 421,00
 <p>L 1500-1600 mm</p>	SUPPORTO a pavimento per 3 moduli Floor support for 3 units Support au sol pour 3 modules Bodengestell für 3 Schränke Soporte de pie para 3 módulos	0,89 20	PS15V (L. 1510 mm)	€ 466,00
		0,95 21	PS16V (L. 1610 mm)	€ 500,00
 <p>L 2000-2100 mm</p>	SUPPORTO a pavimento per 4 moduli Floor support for 4 units Support au sol pour 4 modules Bodengestell für 4 Schränke Soporte de pie para 4 módulos	1,18 24	PS20V (L. 2010 mm)	€ 654,00
		1,24 25	PS21V (L. 2110 mm)	€ 690,00
 <p>L 2500-2600 mm</p>	SUPPORTO a pavimento per 5 moduli Floor support for 5 units Support au sol pour 5 modules Bodengestell für 5 Schränke Soporte de pie para 5 módulos	1,48 27	PS25V (L. 2510 mm)	€ 755,00
		1,54 28	PS26V (L. 2610 mm)	€ 791,00

VELA

LOOK

LIKE

ALA/QUADRO
NOVO/UPRIGHT

MOVINGTRAY
MOVING ARM

PURA
PURASTUDIO

STERIL K

CART

ARMADI

BACINELLE

PIANI
ALZATINE

LAVELLI
RUBINETTI

LAVORAZIONI
ACCESSORI

OPEN BOX
SEGGIOLINI

PROF

MAESTRO

IMPIANTISTICA

PURA | Basamenti

Base units / Bases / Sockel / Bases

LORAN

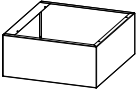
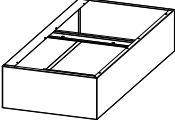
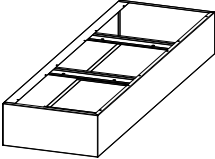
		Descrizione / Description Description / Beschreibung / Descripción	M³ Kg	Articolo Item / Article Artikel / Artículo	Prezzo Price / Prix Preis / Precio
	L 500 x P 445 x H 200 mm	Basamento / Base unit / Base Sockel / Base: L 500	0,04 3,5	PB05	€ 107,00
	L 600 x P 445 x H 200 mm	Basamento / Base unit / Base Sockel / Base: L 600	0,05 4	PB06	€ 124,00
	L 1000 x P 445 x H 200 mm	Basamento / Base unit / Base Sockel / Base: L 1000	0,09 6,5	PB10	€ 160,00
	L 1100 x P 445 x H 200 mm	Basamento / Base unit / Base Sockel / Base: L 1100	0,09 7	PB11	€ 176,00
	L 1500 x P 445 x H 200 mm	Basamento / Base unit / Base Sockel / Base: L 1500	0,13 12	PB15	€ 261,00
	L 1600 x P 445 x H 200 mm	Basamento / Base unit / Base Sockel / Base: L 1600	0,14 12,5	PB16	€ 278,00

PURA | Fianchi Sides / Côtés / Seiten / Laterales

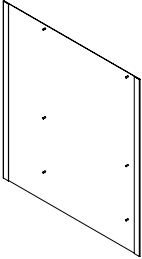
		Descrizione / Description Description / Beschreibung / Descripción	Fianchi Sides / Côtés Seiten / Laterales	M³ Kg	Articolo Item / Article Artikel / Artículo	Prezzo Price / Prix Preis / Precio
	P 640 x H 718 mm SP 3 mm	Fianco laterale Lateral side / Panneau latéral Seitenwand / Panel lateral	Verniciato Painted / Verni Lackiert / Pintado	- 6,3	PFA64	€ 84,00
	P 700 x H 718 mm SP 3 mm	Fianco laterale Lateral side / Panneau latéral Seitenwand / Panel lateral	Verniciato Painted / Verni Lackiert / Pintado	- 6,9	PFA70	€ 91,00
	P 640 x H 1065 mm SP 3 mm	Fianco laterale Lateral side / Panneau latéral Seitenwand / Panel lateral	Verniciato Painted / Verni Lackiert / Pintado	- 9,0	PFB64	€ 120,00
	P 700 x H 1065 mm SP 3 mm	Fianco laterale Lateral side / Panneau latéral Seitenwand / Panel lateral	Verniciato Painted / Verni Lackiert / Pintado	- 9,8	PFB70	€ 132,00
	P 640 x H 328 mm SP 3 mm	Fianco laterale Lateral side / Panneau latéral Seitenwand / Panel lateral	Verniciato Painted / Verni Lackiert / Pintado	- 2,9	PFC64	€ 40,00
	P 700 x H 328 mm SP 3 mm	Fianco laterale Lateral side / Panneau latéral Seitenwand / Panel lateral	Verniciato Painted / Verni Lackiert / Pintado	- 3,1	PFC70	€ 45,00

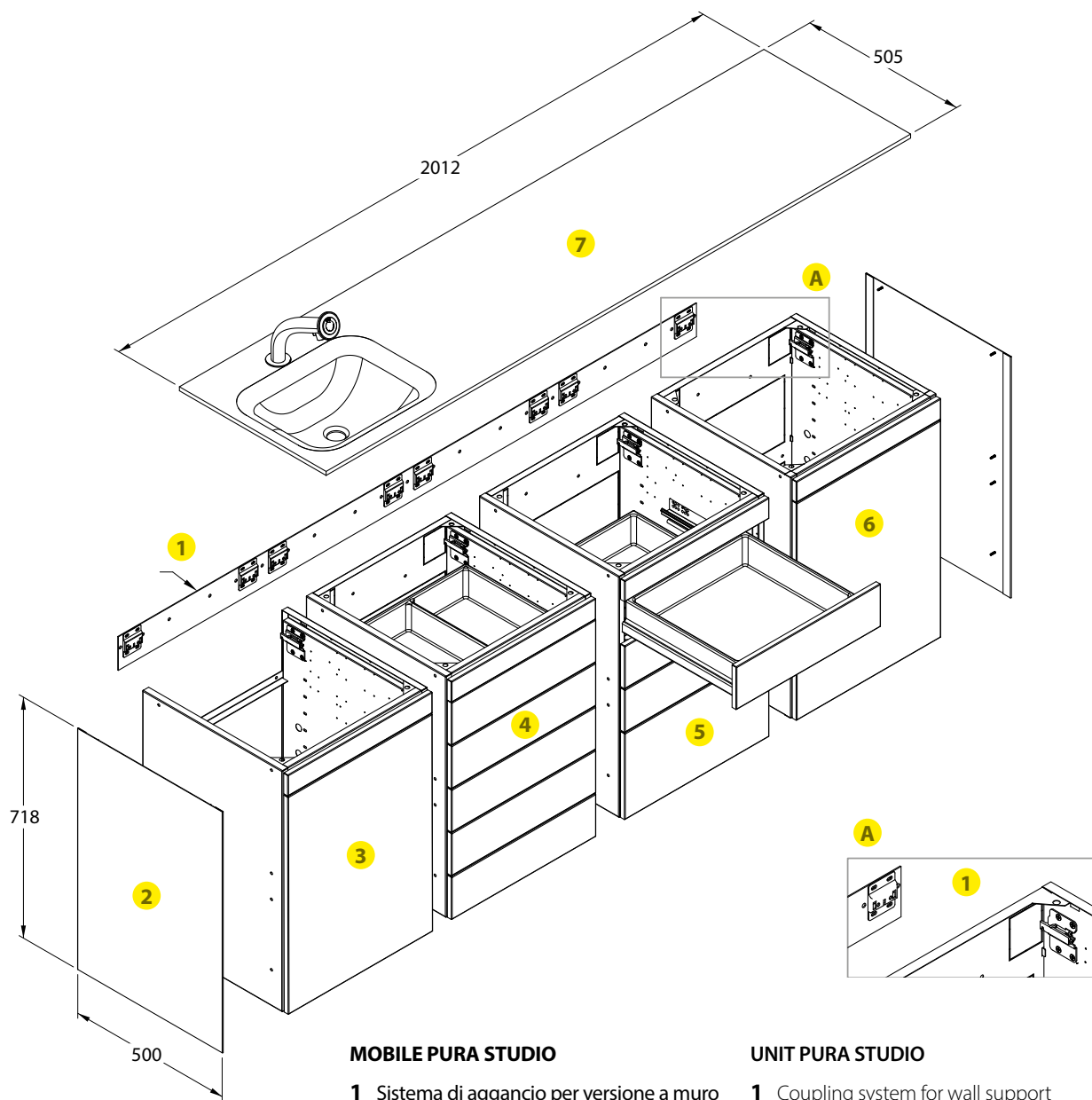

MOBILE PURA STUDIO

- 1 Sistema di aggancio per versione a muro
- 2 Fianco laterale
- 3 Modulo lavello con anta oppure cassettone estraibile
- 4 Modulo con cassetti : 5B
- 5 Modulo con cassetti: 3B + 1D
- 6 Modulo con anta e 2 ripiani interni
- 7 Piano con lavello

H Sottopiano 850 mm

MOBILIER PURA STUDIO

- 1 Système d'accrochage pour le support au mur
- 2 Panneau latéral
- 3 Module d'évier avec porte ou tiroir coulissant
- 4 Module avec tiroirs: 5B
- 5 Module avec tiroirs: 3B + 1D
- 6 Module avec porte et 2 étagères intérieures
- 7 Plan avec évier

H Sous plan de travail 850 mm

PURA STUDIO -MÖBEL

- 1 Kupplungssystem für die Wandbefestigung
- 2 Seitenwand
- 3 Waschbeckenschrank mit Tür oder Schublade
- 4 Modul mit Schubladen: 5B
- 5 Modul mit Schubladen: 3B + 1D
- 6 Modul mit Tür und 2 Einlegeböden
- 7 Arbeitsplatte mit Waschbecken

H Unter der Arbeitsplatte 850 mm

UNIT PURA STUDIO

- 1 Coupling system for wall support
- 2 Lateral side
- 3 Sink module with door or pull-out drawer
- 4 Module with drawers: 5B
- 5 Module with drawers: 3B + 1D
- 6 Module with door and 2 internal shelves
- 7 Top with sink

H Under the top 850 mm

MUEBLE PURA STUDIO

- 1 Placa de soporte para el soporte en pared
- 2 Panel lateral
- 3 Módulo lavabo con puerta o cajon
- 4 Módulo con 5 cajones: 5B
- 5 Módulo con 4 cajones: 3B + 1D
- 6 Módulo con puerta y dos estantes interiores
- 7 Encimera con lavabo

A Bajo encimera 850 mm

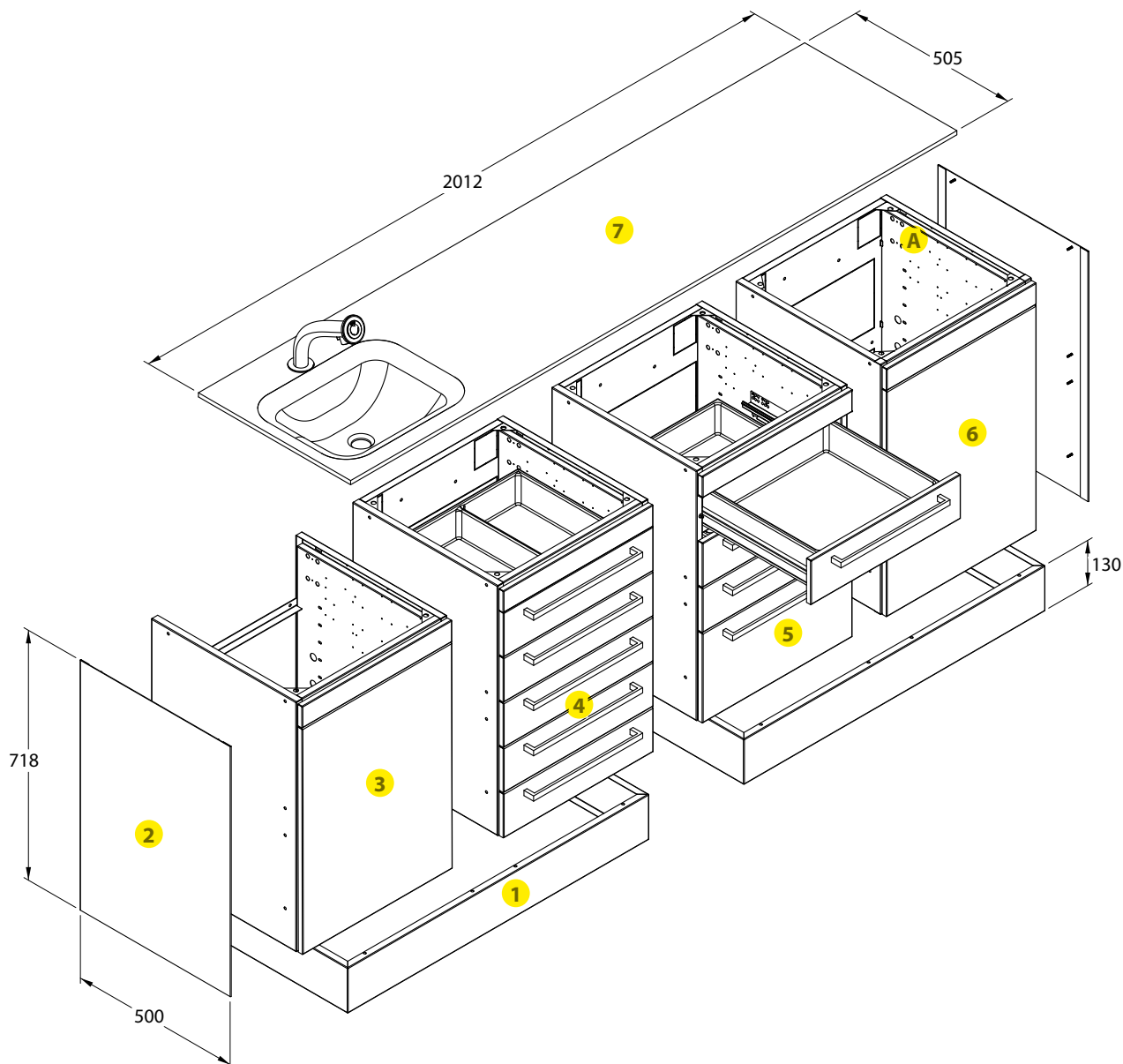

MOBILE PURA STUDIO

- 1 Basamento
- 2 Fianco laterale
- 3 Modulo lavello con anta oppure cassettone estraibile
- 4 Modulo con cassetti : 5B
- 5 Modulo con cassetti: 3B + 1D
- 6 Modulo con anta e 2 ripiani interni
- 7 Piano con lavello

H Sottopiano 850 mm

MOBILIER PURA STUDIO

- 1 Base
- 2 Panneau latéral
- 3 Module d'évier avec porte ou tiroir coulissant
- 4 Module avec tiroirs: 5B
- 5 Module avec tiroirs: 3B + 1D
- 6 Module avec porte et 2 étagères intérieures
- 7 Plan avec évier

H Sous plan de travail 850 mm

PURA STUDIO -MÖBEL

- 1 Sockel
- 2 Seitenwand
- 3 Waschbeckenschrank mit Tür oder Schublade
- 4 Modul mit Schubladen: 5B
- 5 Modul mit Schubladen: 3B + 1D
- 6 Modul mit Tür und 2 Einlegeböden
- 7 Arbeitsplatte mit Waschbecken

H Unter der Arbeitsplatte 850 mm

UNIT PURA STUDIO

- 1 Base unit
- 2 Lateral side
- 3 Sink module with door or pull-out drawer
- 4 Module with drawers: 5B
- 5 Module with drawers: 3B + 1D
- 6 Module with door and 2 internal shelves
- 7 Top with sink

H Under the top 850 mm

MUEBLE PURA STUDIO

- 8 Base
- 9 Panel lateral
- 10 Módulo lavabo con puerta o cajon
- 11 Módulo con 5 cajones: 5B
- 12 Módulo con 4 cajones: 3B + 1D
- 13 Módulo con puerta y dos estantes interiores
- 14 Encimera con lavabo

A Bajo encimera 850 mm

PURA STUDIO | Supporti a muro

LORAN

Wall supports / Supports au mur / Wandbefestigungen / Soportes de pared

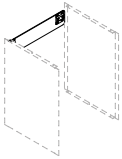
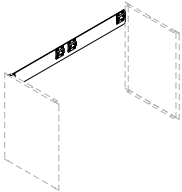
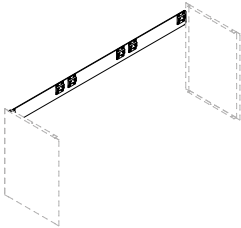
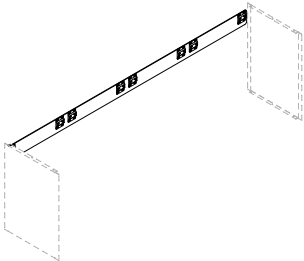
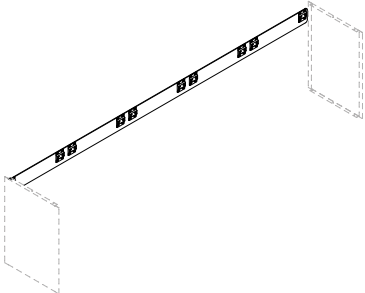
	Descrizione / Description Description / Beschreibung / Descripción	M ³ Kg	Articolo Item / Article Artikel / Artículo	Prezzo Price / Prix Preis / Precio
 <p>L 500 mm L 600 mm</p>	SUPPORTO a muro Wall support for 1 unit Support au mur pour 1 module Wandbefestigung für 1 Schrank Soporte de pared para 1 módulo	0,30 2	PM05V (L. 510 mm)	€ 181,00
		0,36 2	PM06V (L. 610 mm)	€ 186,00
 <p>L 1000 - 1100 mm</p>	SUPPORTO a muro per 2 moduli Wall support for 2 units Support au mur pour 2 modules Wandbefestigung für 2 Schränke Soporte de pared para 2 módulos	0,59 3	PM10V (L. 1010 mm)	€ 199,00
		0,65 3	PM11V (L. 1110 mm)	€ 204,00
 <p>L 1500 - 1600 mm</p>	SUPPORTO a muro per 3 moduli Wall support for 3 units Support au mur pour 3 modules Wandbefestigung für 3 Schränke Soporte de pared para 3 módulos	0,89 6	PM15V (L. 1510 mm)	€ 216,00
		0,95 6	PM16V (L. 1610 mm)	€ 221,00
 <p>L 2000-2100 mm</p>	SUPPORTO a muro per 4 moduli Wall support for 4 units Support au mur pour 4 modules Wandbefestigung für 4 Schränke Soporte de pared para 4 módulos	1,18 7	PM20V (L. 2010 mm)	€ 263,00
		1,24 7	PM21V (L. 2110 mm)	€ 268,00
 <p>L 2500-2600 mm</p>	SUPPORTO a muro per 5 moduli Wall support for 5 units Support au mur pour 5 modules Wandbefestigung für 5 Schränke Soporte de pared para 5 módulos	1,48 9	PM25V (L. 2510 mm)	€ 279,00
		1,54 9	PM26V (L. 2610 mm)	€ 284,00

VELA

LOOK

LIKE

ALA/QUADRO
NOVO/UPRIGHTMOVINGTRAY
MOVING ARMPURA
PURASTUDIO

STERIL K

CART

ARMADI

BACINELLE

PIANI
ALZATINELAVELLI
RUBINETTILAVORAZIONI
ACCESSORIOPEN BOX
SEGGIOLINI

PROF

MAESTRO

IMPIANTISTICA

PURA STUDIO | Basamenti

Base units / Bases / Sockel / Bases

LORAN

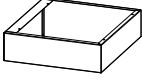
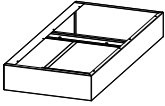
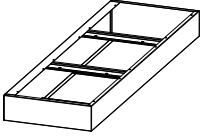
	Descrizione / Description Description / Beschreibung / Descripción	M ³ Kg	Articolo Item / Article Artikel / Artículo	Prezzo Price / Prix Preis / Precio
	L 500 x P 445 x H 130 mm Basamento / Base unit / Base Sockel / Base: L 500	0,04 3,5	PB05A	€ 107,00
	L 600 x P 445 x H 130 mm Basamento / Base unit / Base Sockel / Base: L 600	0,05 4	PB06A	€ 124,00
	L 1000 x P 445 x H 130 mm Basamento / Base unit / Base Sockel / Base: L 1000	0,09 6,5	PB10A	€ 160,00
	L 1100 x P 445 x H 130 mm Basamento / Base unit / Base Sockel / Base: L 1100	0,09 7	PB11A	€ 176,00
	L 1500 x P 445 x H 130 mm Basamento / Base unit / Base Sockel / Base: L 1500	0,13 12	PB15A	€ 261,00
	L 1600 x P 445 x H 130 mm Basamento / Base unit / Base Sockel / Base: L 1600	0,14 12,5	PB16A	€ 278,00

PURA STUDIO | Fianchi Sides / Côtés / Seiten / Laterales

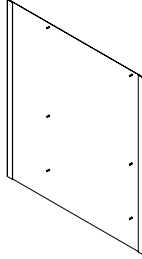
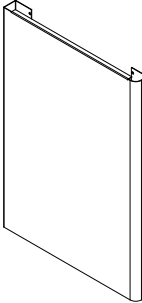
	Descrizione / Description Description / Beschreibung / Descripción	Fianchi Sides / Côtés Seiten / Laterales	M ³ Kg	Articolo Item / Article Artikel / Artículo	Prezzo Price / Prix Preis / Precio
	P 505 x H 718 mm SP 3 mm Fianco laterale Lateral side / Panneau latéral Seitenwand / Panel lateral	Verniciato Painted / Verni Lackiert / Pintado	- 5,3	PFA50	€ 84,00
	P 600 x H 718 mm SP 3 mm Fianco laterale Lateral side / Panneau latéral Seitenwand / Panel lateral	Verniciato Painted / Verni Lackiert / Pintado	- 5,9	PFA60	€ 84,00
	P 500 x H 718 mm SP 46 mm Fianco laterale Round Round lateral side Panneau latéral Round Round Seitenwand Panel lateral Round	Verniciato Painted / Verni Lackiert / Pintado	- 5,8	PFA50R	€ 184,00
	P 595 x H 718 mm SP 46 mm Fianco laterale Round Round lateral side Panneau latéral Round Round Seitenwand Panel lateral Round	Verniciato Painted / Verni Lackiert / Pintado	- 7	PFA60R	€ 184,00

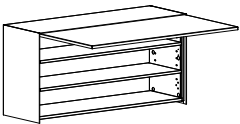
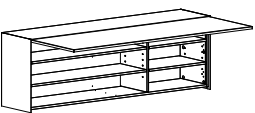
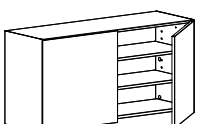
	Descrizione / Description Description / Beschreibung / Descripción	Fianchi Sides / Côtés Seiten / Laterales	M³ Kg	Articolo Item / Article Artikel/Artículo	Prezzo Price / Prix Preis / Precio
 <p>PENSILE L 1006 mm con anta a ribalta verniciata o in vetro, con 2 ripiani interni</p> <p>Wall unit L 1006 mm with flap painted or glass door, with 2 inner shelves</p> <p>Élément haut L 1006 mm avec porte battante peinte ou en verre, avec 2 étagères intérieures</p> <p>Hängeschrank L 1006 mm mit lackierter Kipptür oder Glastür und 2 Inneneinlegeböden</p> <p>Mueble colgante L 1006 mm con hoja basculante pintada o de vidrio, con 2 estantes internos</p> <p>L 1006 x P 350 x H 500 mm</p>	<p>Anta verniciata Painted / Verni Lackiert Pintado</p> <p>0,16 ----- 34,5</p> <p>PVOA € 939,00</p>				
	<p>Anta in vetro Glass / Verre Glas / Vidrio</p> <p>0,16 ----- 34,5</p> <p>PVOAV € 1.210,00</p>				
 <p>PENSILE L 1506 mm con anta a ribalta verniciata o in vetro, con 2+2 ripiani interni e divisorio verticale</p> <p>Wall unit L 1506 mm with flap painted or glass door, with 2+2 inner shelves and vertical partition</p> <p>Élément haut L 1506 mm avec porte battante peinte ou en verre, avec 2+2 étagères intérieures et séparation verticale</p> <p>Hängeschrank L 1506 mm mit lackierter Kipptür oder Glastür, 2+2 Inneneinlegeböden und senkrechtem Trennelement</p> <p>Mueble colgante L 1506 mm con hoja basculante pintada o de vidrio, con 2+2 estantes internos y separador vertical</p> <p>L 1506 x P 350 x H 500 mm</p>	<p>Anta verniciata Painted / Verni Lackiert Pintado</p> <p>0,25 ----- 63,5</p> <p>PVOB € 1.228,00</p>				
	<p>Anta in vetro Glass / Verre Glas / Vidrio</p> <p>0,25 ----- 63,5</p> <p>PVOBV € 1.594,00</p>				
 <p>PENSILE L 1006 mm con 2 ante battenti e 2 ripiani interni</p> <p>Cupboard L 1006 mm with 2 doors and 2 internal shelves</p> <p>Élément mural L 1006 mm avec 2 portes battantes et 2 étagères intérieures</p> <p>Hängeschrank L 1006 mm mit 2 Türflügeln und 2 Inneneinlegeböden</p> <p>Mueble colgante L 1006 mm con 2 hojas batientes y 2 estantes interiores</p> <p>L 1006 x P 350 x H 500 mm</p>	<p>Verniciato Painted / Verni Lackiert Pintado</p> <p>0,25 ----- 34</p> <p>PVOC € 788,00</p>				

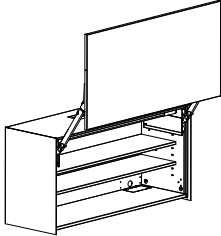
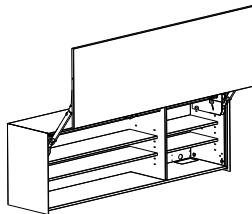
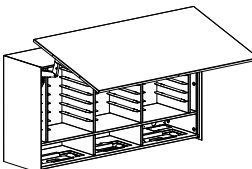
	Descrizione / Description Description / Beschreibung / Descripción	Fianchi Sides / Côtés Seiten / Laterales	M³ Kg	Articolo Item / Article Artikel/Artículo	Prezzo Price / Prix Preis / Precio
	<p>PENSILE L 1006 mm con anta apertura verticale verniciata, con 2 ripiani interni</p> <p>Wall unit L 1006 mm with painted vertical opening door, with 2 internal shelves</p> <p>Élément haut L 1006 mm avec porte ouverture vertical peinte, avec 2 étagères intérieures</p> <p>Hängeschrank L 1006 mm mit lackierter vertikaler Tür, mit 2 Innenregalen</p> <p>Mueble colgante L 1006 mm con puerta de apertura vertical pintada, con 2 estantes interiores</p>				
L 1006 x P 350 x H 500 mm			0,25 52	PVOG	€ 1.135,00
	<p>PENSILE L 1506 mm con anta apertura verticale verniciata, con 2+2 ripiani interni e divisorio verticale</p> <p>Wall unit L 1506 mm with painted vertical opening door, with 2+2 inner shelves and vertical partition</p> <p>Élément haut L 1506 mm avec porte ouverture vertical peinte, avec 2+2 étagères intérieures et séparation verticale</p> <p>Hängeschrank L 1506 mm mit lackierter vertikaler Tür, 2+2 Inneneinlegeböden und senkrechtem Trennelement</p> <p>Mueble colgante L 1506 mm con puerta de apertura vertical pintada, con 2+2 estantes internos y separador vertical</p>				
L 1506 x P 350 x H 500 mm			0,25 70	PVOI	€ 1.481,00
	<p>PENSILE L 1206 mm con anta a ribalta verniciata, fondo con 3 vani predisposti per monouso, 3 vani con divisori predisposti per 12 tubs</p> <p>Wall cabinet L 1206 mm with flip-up painted door, base with 3 compartments for disposables, 3 compartments for 12 tubs</p> <p>Mueble colgante L1206 mm con puerta abatible pintada, fondo con 3 compartimentos para desechables, 3 compartimentos con separadores para 12 tubs</p> <p>Hängeschrank L 1206 mm mit lackierter Klapptür, Unterteil mit 3 Fächern für Einwegartikel vorbereitet, 3 Fächer mit Trennwänden für 12 Behälter</p> <p>Mueble colgante L1206 con puerta abatible pintada, fondo con 3 compartimentos para desechables, 3 compartimentos con separadores para 12 tubs</p>				
L 1206 x P 350 x H 640 mm			0,25 78	PVOJ	€ 1.535,00

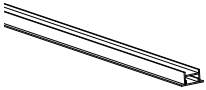
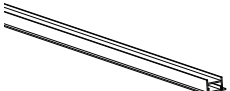
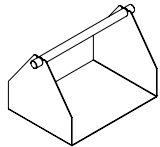
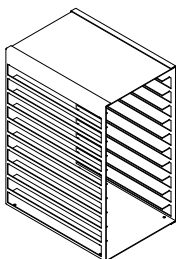
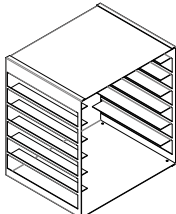
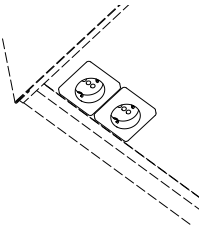
	Descrizione / Description Description / Beschreibung / Descripción	Fianchi Sides / Côtés Seiten / Laterales	M³ Kg	Articolo Item / Article Artikel/Artículo	Prezzo Price / Prix Preis / Precio
	LAMPADA A LED sottopensile/ sottomensola con interruttore touch Under-floor/-shelf LED lamp with touch switch Lampe à LED sous élément haut/sous étagère avec interrupteur tactile LED-lampe für Unterbau Hängeschrank/Regal mit Touch-Schalter Lámpara de LED debajo del mueble colgante/ estante con interruptor táctil	<i>Fino a/Up to</i> L = 1000 mm		PLEDE10	€ 201,00
		<i>L=da/from 1000</i> <i>a/to 1500mm</i>		PLEDE15	€ 244,00
	LAMPADA A LED interna al pensile LED lamp inside the wall unit Lampe à LED à l'intérieur de l'élément haut LED-lampe Hängeschrankinnenseite Lámpara de LED incorporada dentro del mueble colgante	<i>Fino a/Up to</i> L = 1000 mm		PLEDI10	€ 261,00
		<i>L=da/from 1000</i> <i>a/to 1500mm</i>		PLEDI15	€ 304,00
	Portarotolo interno al pensile Roll holder inside the cupboard Porte-rouleau intérieur pour élément mural Rollenhalterung für Hängeschrankinnenseite Porta-rollos dentro del mueble colgante		- 2,3	PAP01	€ 107,00
	Porta Tray interno al pensile Tray holder inside the cupboard Porte Tray intérieur pour élément mural Trayhalterung für Hängeschrankinnenseite Porta-Tray dentro del mueble colgante		- 6,7	PAP02	€ 141,00
	Porta Tubs interno al pensile Tubs holder inside the cupboard Porte Tubs intérieur pour élément mural Tubhalterung für Hängeschrankinnenseite Porta-Tubs dentro del mueble colgante		- 7	PAP03	€ 178,00
	Coppia di prese di corrente schuko sotto al pensile Pair of Schuko power outlets under the wall unit Deux prises de courant Schuko sous l'élément haut 1 Paar Schuko-Stromsteckdosen unter Hängeschrank Par de tomas de corriente schuko debajo del mueble colgante			PAP04	€ 73,00

PURA | Barra attrezzata

Equipped bar / Barre équipée / Stangenausstattung / Barra equipada

LORAN

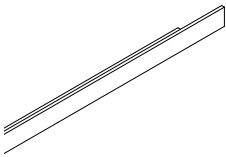
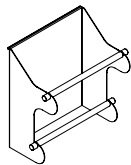
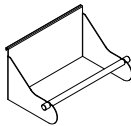
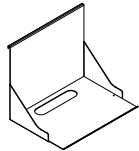
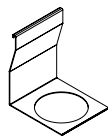
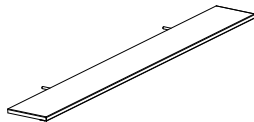
	Descrizione / Description Description / Beschreibung / Descripción	M ³ Kg	Articolo Item / Article Artikel / Artículo	Prezzo Price / Prix Preis / Precio
	Barra attrezzata in acciaio inox: al metro lineare Equipped bar in stainless steel: per meter Barre équipée en acier inox: au mètre Edelstahl - Stangenausstattung: meterweise Barra equipada de acero inoxidable: por metro	3 Kg/m	PA01	€/m 132,00
SP 15 x H 50 mm				
	Portarotolo da esterno in acciaio inox Roll holder for exterior in stainless steel Porte-rouleau extérieur en acier inox Edelstahl-Rollenhalterung für außen Porta-rollos para exterior de acero inoxidable	- 4,5	PA02	€ 230,00
L 386 mm x P 250 x H 400 mm				
	Portarotolo da esterno singolo in acciaio inox Single roll holder for exterior in stainless steel Porte-rouleau simple extérieur en acier inox Einzelner Edelstahl-Rollenhalterung für außen Porta-rollos individual para exterior de acero inoxidable	- 3	PA06	€ 210,00
L 386 mm x P 250 x H 200 mm				
	Supporto per attrezzature in acciaio inox Support for equipments in stainless steel Support pour équipements en acier inox Edelstahl-Halterung für Geräte Soporte para equipos de acero inoxidable	- 3,7	PA03	€ 189,00
L 350 mm x P 270 x H 300 mm				
	Supporto per contenitore aghi in acciaio inox (foro ø 130 mm) Support for needle container in stainless steel (hole ø 130 mm) Support pour conteneur à aiguilles en acier inox (trou ø 130 mm) Halterung für Nadelbehälter aus Edelstahl (Bohrung ø 130 mm) Soporte para contenedor agujas de acero inoxidable (orificio ø 130 mm)	- 0,9	PA04	€ 107,00
L 160 mm x P 170 x H 210 mm				
	Mensola completa di kit di fissaggio: al metro lineare Shelf with mounting kit: per meter Étagère fournie avec kit de fixation: au mètre Regal mit Befestigungsset: meterweise Repisa con kit de fijación: por metro	3,5 Kg/m	PME	€/m 130,00
P 180 mm				

VELA

LOOK

LIKE

ALA/QUADRO
NOVO/UPRIGHTMOVINGTRAY
MOVING ARMPURA
PURASTUDIO

STERIL K

CART

ARMADI

BACINELLE

PIANI
ALZATINELAVELLI
RUBINETTILAVORAZIONI
ACCESSORIOPEN BOX
SEGGIOLINI

PROF

MAESTRO

IMPIANTISTICA

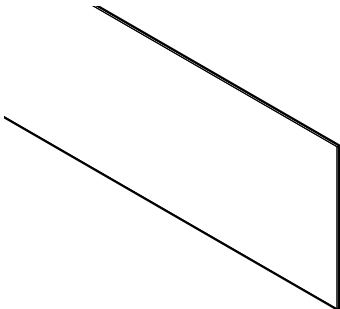
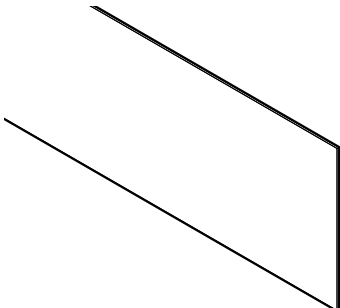
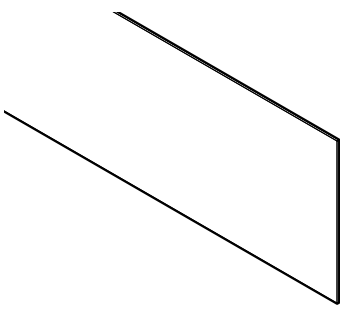
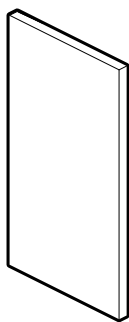
	Descrizione / Description Description / Beschreibung / Descripción	M ³ Kg	Articolo Item / Article Artikel / Artículo	Prezzo Price / Prix Preis / Precio
	<p>Tamponamento di chiusura tra piano e pensile in acciaio inox: al metro lineare</p> <p>Closing element between top and shelf in stainless steel: per meter</p> <p>Cache de fermeture entre le plan et l'élément mural en acier inox: au mètre</p> <p>Schließabdichtung zwischen Ebene und Hängeschrank aus Edelstahl: meterweise</p> <p>Elemento de relleno entre encimera y mueble colgante de acero inoxidable: por metro</p>	- 9	PTCI	€ 661,00
P 20 x H 576 mm				
	<p>Tamponamento di chiusura tra piano e pensile in stratificato: al metro lineare</p> <p>Closing element between top and shelf in stratified laminate: per meter</p> <p>Cache de fermeture entre le plan et l'élément mural en stratifié: au mètre</p> <p>Schließabdichtung zwischen Ebene und Hängeschrank aus Verbundmaterial: meterweise</p> <p>Elemento de relleno entre encimera y mueble colgante de estratificado: por metro</p>	- 11,1	PTCS	€ 450,00
P 12 x H 584 mm				
	<p>Tamponamento di chiusura tra piano e pensile in Corian®: al metro lineare</p> <p>Closing element between top and shelf in Corian®: per meter</p> <p>Cache de fermeture entre le plan et l'élément mural en Corian®: au mètre</p> <p>Schließabdichtung zwischen Ebene und Hängeschrank aus Corian®: meterweise</p> <p>Elemento de relleno entre encimera y mueble colgante de Corian®: por metro</p>	- 12,7	PTCC	€ 626,00
P 12 x H 584 mm				
	<p>Pannello laterale verniciato di sostegno piano</p> <p>Painted side panel supporting the top</p> <p>Panneau latéral peint de soutien du plan</p> <p>Lackiertes Seitenpaneel zum Abstützen der Ebene</p> <p>Panel lateral pintado para soporte encimera</p>	- 14	PSLS	€ 218,00
L 25 x P 640 x H 918 mm				

VELA

LOOK

LIKE

ALA/QUADRO
NOVO/UPRIGHT

MOVINGTRAY
MOVING ARM

PURA
PURASTUDIO

STERIL K

CART

ARMADI

BACINELLE

PIANI
ALZATINE

LAVELLI
RUBINETTI

LAVORAZIONI
ACCESSORI

OPEN BOX
SEGGIOLINI

PROF

MAESTRO

IMPIANTISTICA

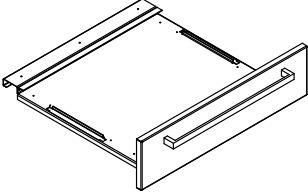
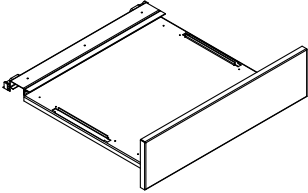
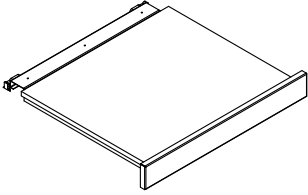
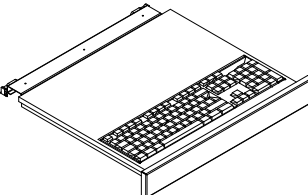
	Descrizione / Description Description / Beschreibung / Descripción	M ³ Kg	Articolo Item / Article Artikel / Artículo	Prezzo Price / Prix Preis / Precio	
	CASSETTO con maniglia Drawer with handle Tiroir avec poignée Schublade mit Griff Cajón con tirador	-			
		A) H 65	4,2	PCAAM	€ 147,00
		B) H 130	5,2	PCABM	€ 165,00
		C) H 195	5,8	PCACM	€ 195,00
	D) H 260	6,8	PCADM	€ 207,00	
	CASSETTO Push-Pull Drawer Push-Pull Tiroir Push-Pull Schublade Push-Pull Cajón Push-Pull	-			
		A) H 65	4	PCAAP	€ 160,00
		B) H 130	5	PCABP	€ 178,00
		C) H 195	5,8	PCACP	€ 207,00
	D) H 260	6,6	PCADP	€ 218,00	
	CASSETTO estraibile con ripiano in Corian® o stratificato Pull-out drawer with top in Corian® or stratified laminate Tiroir extractible avec tablette en Corian® ou stratifié Ausziehbarer Schublade mit Einlegeboden aus Corian® oder Verbundmaterial Cajón extraíble con estante de Corian® o estratificado	-			
		Stratificato Stratifié Schichtstoff Estratificado	8,8	PCA AES (L 500 mm)	€ 266,00
		Corian®	9,3	PCA AEC (L 500 mm)	€ 296,00
		Stratificato Stratifié Schichtstoff Estratificado	9,3	PCA AES6 (L 600 mm)	€ 307,00
	Corian®	9,8	PCA AEC6 (L 600 mm)	€ 336,00	
	CASSETTO estraibile per tastiera (L 385 mm H 25 mm max) Removable drawer for keyboard (L 385 mm H 25 mm max) Tiroir extractible pour clavier (L 385 mm H 25 mm max) Ausziehbare schublade für Tastatur (L 385 mm H 25 mm max) Cajón extraíble para teclado (L 385 mm H 25 mm máx)		PCAAPK	€ 266,00	

L 500
L 600

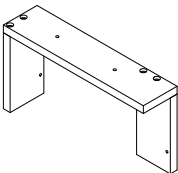
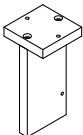
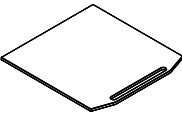
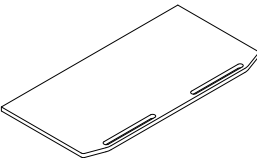
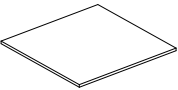
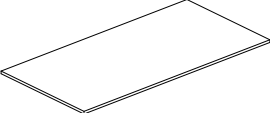
	Descrizione / Description Description / Beschreibung / Descripción	M³ Kg	Articolo Item / Article Artikel / Artículo	Prezzo Price / Prix Preis / Precio
	PIEDE in alluminio Aluminium foot Pied en aluminium Aluminiumfuß Pata de aluminio	DX / RH Droite / Rechts Dcho	- 4	PPAD € 137,00
		SX / LH Gauche / Links Izq	- 4	PPAS € 137,00
	PIEDE CENTRALE in alluminio Aluminium foot Pied en aluminium Aluminiumfuß Pata de aluminio	- 1,5	PPAC	€ 64,00
	PIANO sagomato per servomobile Shaped top for movable unit Plan façonné pour module mobile Geformte Arbeitsplatte für Rollenschrank Encimera perfilada para módulo móvil	Corian®	- 5,7	PPSC € 263,00
		Stratificato Stratified / Stratifié Schichtstoff Estratificado	- 5	PPSS € 228,00
		Vetro / Glass Verre / Glas / Vidrio	- 10	PPSV € 354,00
		Extra-chiaro / Extra clear / Transparent / Transparent / Extra-claro		€ +82,00
		Satinato / Satin / Dépoli / Satiniert Satinado		€ +88,00
		Corian®	- 11,5	PPSC2 € 452,00
	PIANO sagomato per servomobile Shaped top for movable unit Plan façonné pour module mobile Geformte Arbeitsplatte für Rollenschrank Encimera perfilada para módulo móvil	Stratificato Stratified / Stratifié Schichtstoff Estratificado	- 10	PPSS2 € 385,00
		Vetro / Glass Verre / Glas / Vidrio	- 20	PPSV2 € 498,00
		Extra-chiaro / Extra clear / Transparent / Transparent / Extra-claro		€ +82,00
		Satinato / Satin / Dépoli / Satiniert Satinado		€ +88,00
		Corian®	- 11,5	PPSC2 € 452,00
	PIANO inox L 510 mm per servomobile spessore 20 mm Top for movable unit, 20 mm thick Plan pour module mobile, ép. 20 mm Arbeitsplatte für Rollenschrank, St. 20 mm Encimera para módulo móvil, de 20 mm de esp.	- 6	PPSI	€ 305,00
	PIANO inox L 1010 mm per servomobile spessore 20 mm Top for movable unit, 20 mm thick Plan pour module mobile, ép. 20 mm Arbeitsplatte für Rollenschrank, St. 20 mm Encimera para módulo móvil, de 20 mm de esp.	- 12	PPSI2	€ 608,00

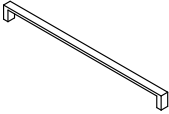
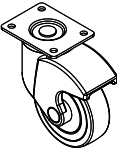
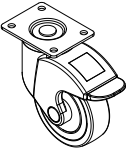
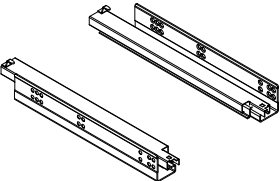
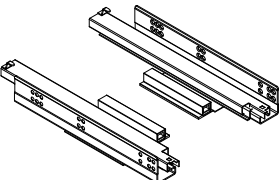
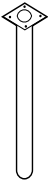
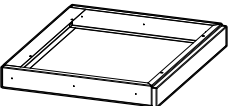
	Descrizione / Description Description / Beschreibung / Descripción	M³ Kg	Articolo Item / Article Artikel / Artículo	Prezzo Price / Prix Preis / Precio
	MANIGLIA in alluminio per "Look"/"Pura" Aluminium handle for "Look"/"Pura" Poignée en aluminium pour "Look"/"Pura" Griff aus Aluminium für "Look"/"Pura" Tirador de aluminio para "Look"/"Pura"	Interasse / Wheelbase Entraxe / Abstand Distancia entre ejes 352	- 0,4	MA020 € 24,00
	RUOTA senza freno Castor without brake Roue sans frein Rad ohne Bremse Rueda sin freno	- 0,6	RUO26 € 29,00	
	RUOTA con freno Castor with brake Roue avec frein Rad mit Bremse Rueda con freno	- 0,7	RUO27 € 37,00	
	COPPIA DI GUIDE con rientro ammortizzato per cassetto con maniglia Pair of guides with soft closing for drawer provided with handle Couple de glissières avec amortisseur pour tiroir avec poignée EIN PAAR Führungen mit Softeinzug für Schublade mit Griff Par de guías con cierre suave para cajón con tirador	- 1	GUI66 € 33,00	
	COPPIA DI GUIDE per cassetto Push-Pull Pair of guides for Push-Pull drawer Couple de glissières pour tiroir Push-Pull Eine Paar Führungen für Push-Pull Schublade Par de guías para cajón Push-Pull	- 1	GUI67 € 43,00	
 H 918 mm - Ø 60	Supporto in tubolare per piano Tube top bracket Support en tube pour plan Rundrohrbeine für Arbeitsplatte Soporte en tubular para la encimera	- 8	PSTP € 95,00	
 L 600 x P 500 x H 65 mm	Cornice di finitura H 65 mm per vano L 600 mm completa di frontale Finishing frame h 65 mm for compartment l 600 mm with front Cadre de finition h 65 mm pour compartiment l 600 mm avec façade Zierrahmen H 65 mm für Fach L 600 mm mit Front Marco de acabado h 65 mm para compartimento l 600 mm con frente	- 3	PCRA € 94,00	

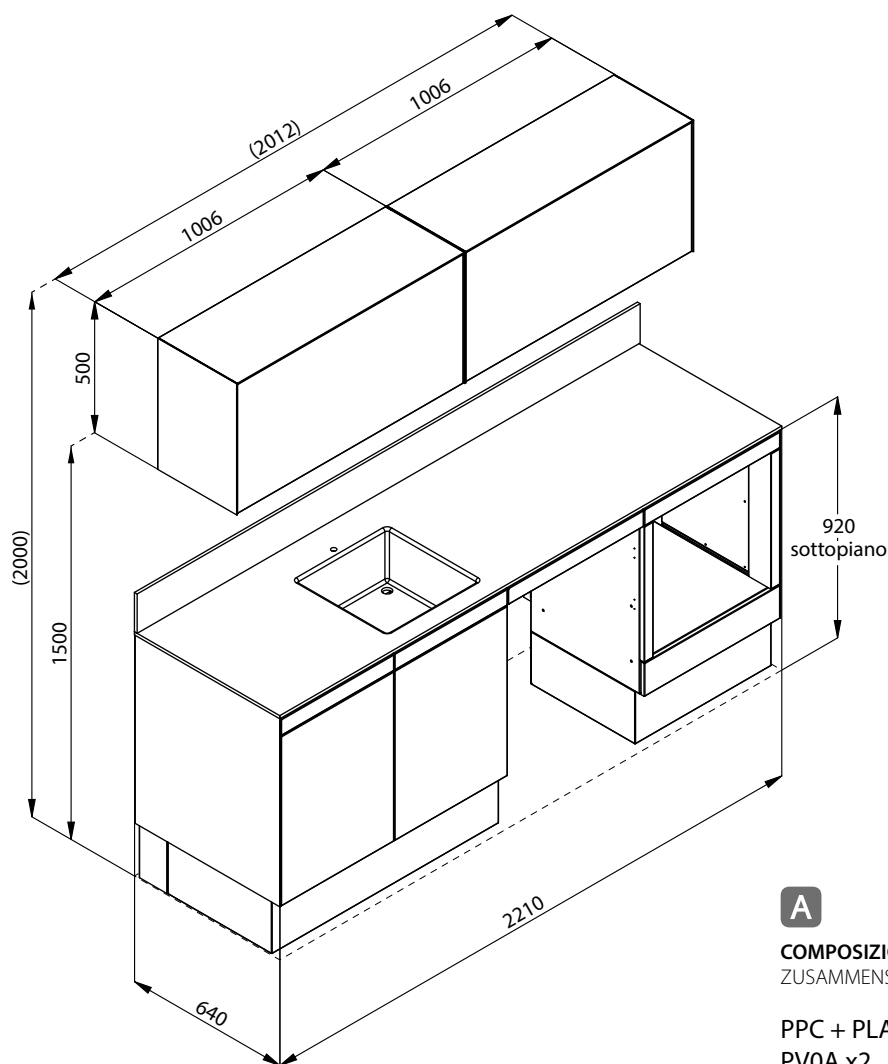

A

**COMPOSIZIONE / COMPOSITION / COMPOSITION
ZUSAMMENSTELLUNG / COMPOSICIÓN**

PPC + PLA + PCRA + PAA
PV0A x2

**La composizione è comprensiva di bacinelle standard.
Rubinetto escluso.**

Trays included. Mixer excluded
Intérieurs de tiroirs inclus. Robinet pas compris.
Standard Schubladeneinsätze sind enthalten. Armatur ist ausgeschlossen.
La composición incluye bandejas estándar.
Grifo excluido.

		Con piedi / On feet Sur pieds / Mit Füßen / Con patas		Basamento / Base units / Bases / Sockel / Bases		
		Maniglia Handle / Poignée Griff / Tirador	Push-Pull	Maniglia Handle / Poignée Griff / Tirador	Push-Pull	
1	Piano in laminato Fenix® + Alzatina "Fenix®" - laminate worktop / Plan de travail en laminé "Fenix®" / Arbeitsplatte aus Laminat "Fenix®" / Encimera de laminado "Fenix®"	+V2S	€ 5.932,00	€ 5.979,00	€ 5.546,00	€ 5.592,00
2	Piano in stratificato + Alzatina Stratified top / Plan stratifié / Arbeitsplatte aus Schichtstoff / Encimera de estratificado	+V2S	€ 6.616,00	€ 6.662,00	€ 6.229,00	€ 6.275,00
3	Piano in acciaio inox + Alzatina Steel top / Plan en acier Arbeitsplatte aus stahl / Encimera de acero	+V11 +VAA	€ 7.457,00	€ 7.504,00	€ 6.985,00	€ 7.032,00
4	Piano in Corian® + Alzatina Corian® top / Plan en Corian® Arbeitsplatte aus Corian® / Encimera de Corian®	+VPC	€ 7.971,00	€ 8.017,00	€ 7.585,00	€ 7.631,00

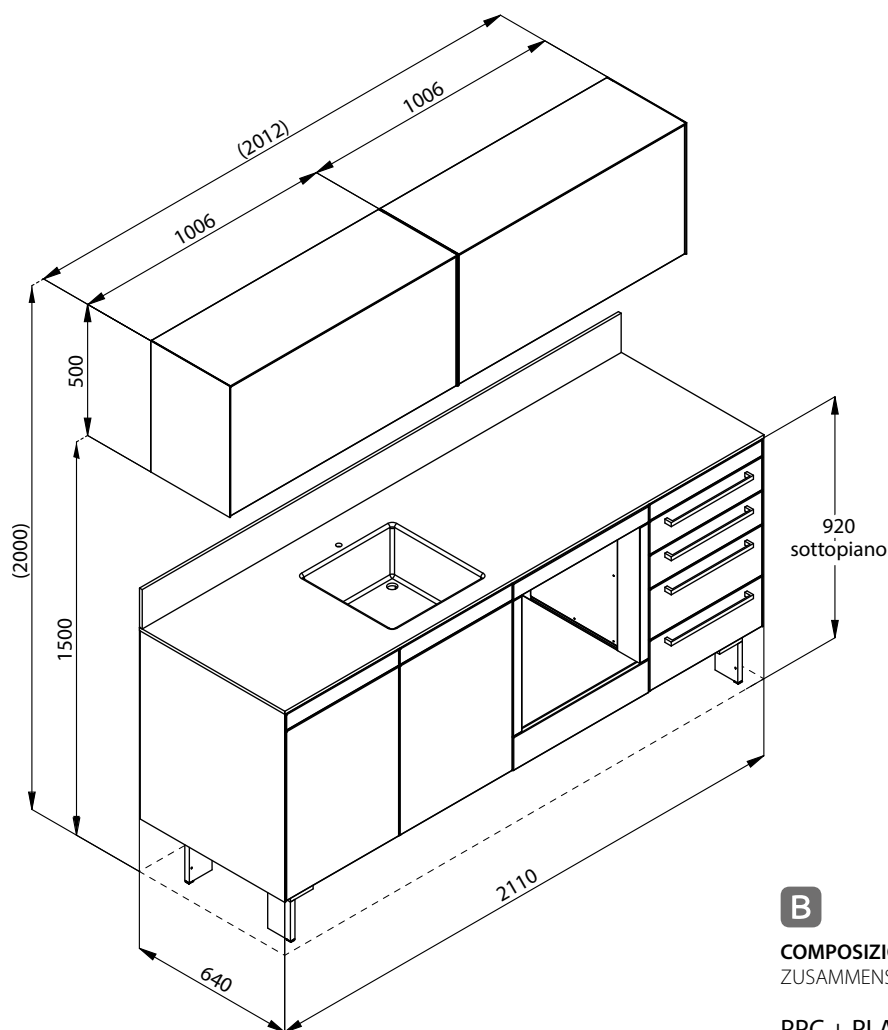

B

**COMPOSIZIONE / COMPOSITION / COMPOSITION
ZUSAMMENSTELLUNG / COMPOSICIÓN**

PPC + PLA + PAA + P4B
PV0A x2

**La composizione è comprensiva di bacinelle standard.
Rubinetto escluso.**

Trays included. Mixer excluded
Intérieurs de tiroirs inclus. Robinet pas compris.
Standard Schubladeneinsätze sind enthalten. Armatur ist ausgeschlossen.
La composición incluye bandejas estándar.
Grifo excluido.

		Con piedi / On feet Sur pieds / Mit Füßen / Con patas		Basamento / Base units / Bases / Sockel / Bases		
		Maniglia Handle / Poignée Griff / Tirador	Push-Pull	Maniglia Handle / Poignée Griff / Tirador	Push-Pull	
1	Piano in laminato Fenix® + Alzatina "Fenix®" - laminate worktop / Plan de travail en laminé "Fenix®" / Arbeitsplatte aus Laminat "Fenix®" / Encimera de laminado "Fenix®"	+V2S	€ 6.544,00	€ 6.638,00	€ 6.276,00	€ 6.370,00
2	Piano in stratificato + Alzatina Stratified top / Plan stratifié / Arbeitsplatte aus Schichtstoff / Encimera de estratificado	+V2S	€ 7.231,00	€ 7.324,00	€ 6.963,00	€ 7.056,00
3	Piano in acciaio inox + Alzatina Steel top / Plan en acier Arbeitsplatte aus stahl / Encimera de acero	+V11 +VAA	€ 8.021,00	€ 8.115,00	€ 7.752,00	€ 7.846,00
4	Piano in Corian® + Alzatina Corian® top / Plan en Corian® Arbeitsplatte aus Corian® / Encimera de Corian®	+VPC	€ 8.537,00	€ 8.631,00	€ 8.269,00	€ 8.363,00

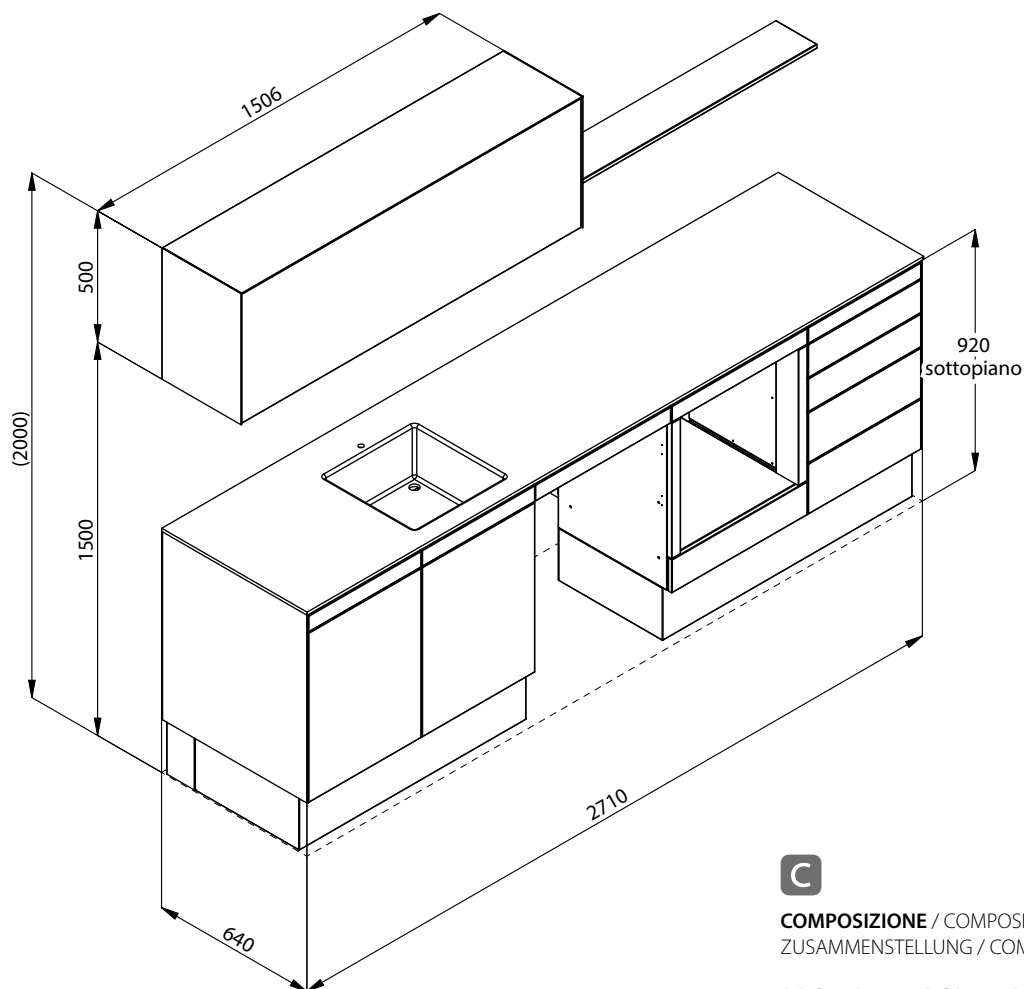

**COMPOSIZIONE / COMPOSITION / COMPOSITION
ZUSAMMENSTELLUNG / COMPOSICIÓN**

PPC + PLA + PCRA + PAA + P4B
PV0B + PME (L 1200 mm)

**La composizione è comprensiva di bacinelle standard.
Rubinetto escluso.**

Trays included. Mixer excluded
Intérieurs de tiroirs inclus. Robinet pas compris.
Standard Schubladeneinsätze sind enthalten. Armatur ist ausgeschlossen.
La composición incluye bandejas estándar.
Grifo excluido.

		Con piedi / On feet Sur pieds / Mit Füßen / Con patas		Basamento / Base units / Bases / Sockel / Bases		
		Maniglia Handle / Poignée Griff / Tirador	Push-Pull	Maniglia Handle / Poignée Griff / Tirador	Push-Pull	
1	Piano in laminato Fenix® "Fenix®" - laminate worktop / Plan de travail en laminé "Fenix®" / Arbeitsplatte aus Laminat "Fenix®" / Encimera de laminado "Fenix®"	+ V2S	€ 6.228,00	€ 6.322,00	€ 5.844,00	€ 5.938,00
2	Piano in stratificato Stratified top / Plan stratifié / Arbeitsplatte aus Schichtstoff / Encimera de estratificado	+ V2S	€ 6.999,00	€ 7.092,00	€ 6.615,00	€ 6.708,00
3	Piano in acciaio inox Steel top / Plan en acier Arbeitsplatte aus stahl / Encimera de acero	+ V11 + VAA	€ 7.773,00	€ 7.867,00	€ 7.389,00	€ 7.483,00
4	Piano in Corian® Corian® top / Plan en Corian® Arbeitsplatte aus Corian® / Encimera de Corian®	+ VPC	€ 8.345,00	€ 8.439,00	€ 7.961,00	€ 8.054,00

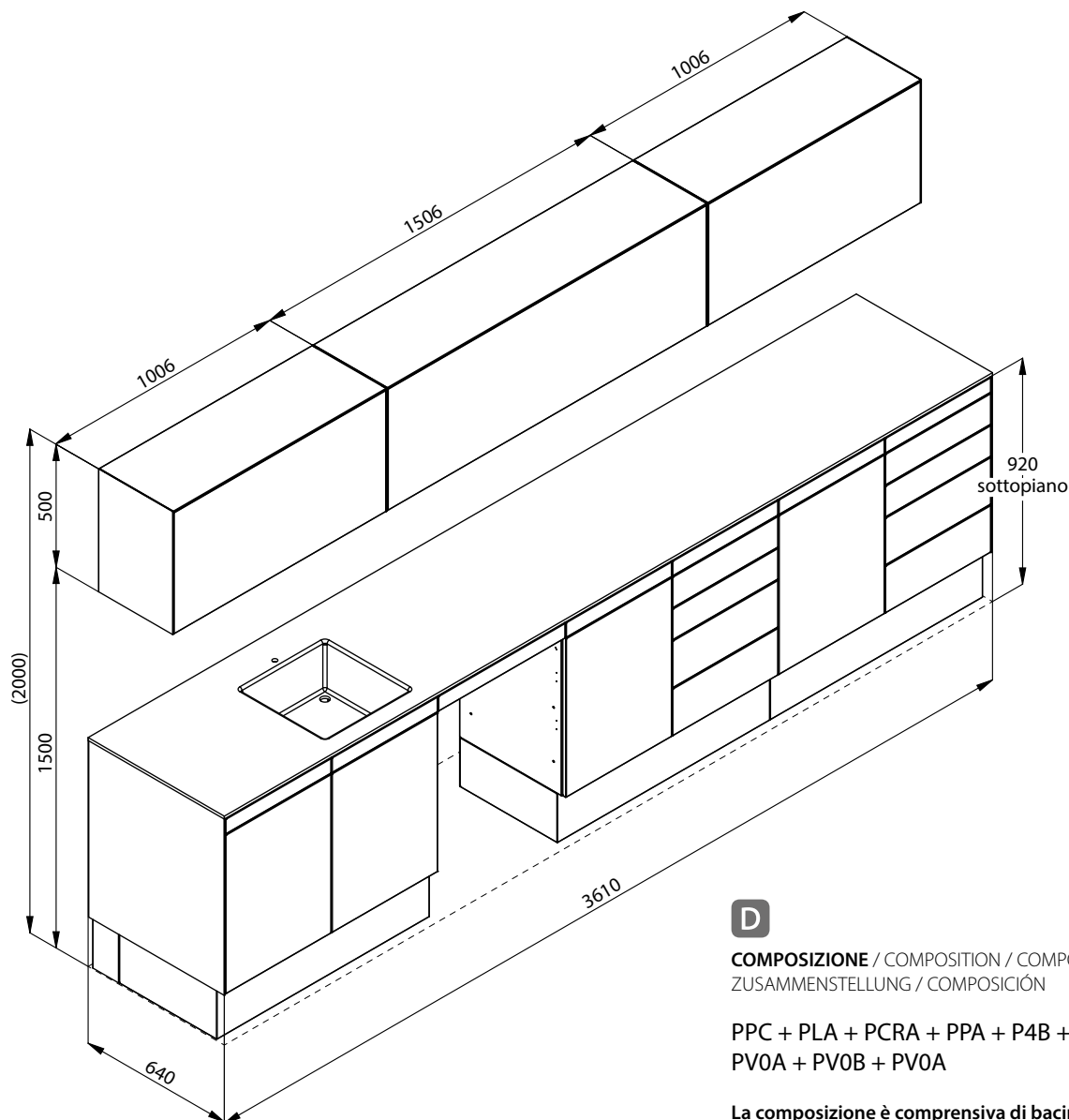

D

**COMPOSIZIONE / COMPOSITION / COMPOSITION
ZUSAMMENSTELLUNG / COMPOSICIÓN**

PPC + PLA + PCRA + PPA + P4B + PPA + P4B
PVOA + PVOB + PVOA

**La composizione è comprensiva di bacinelle standard.
Rubinetto escluso.**

Trays included. Mixer excluded
Intérieurs de tiroirs inclus. Robinet pas compris.
Standard Schubladeneinsätze sind enthalten. Armatur ist ausgeschlossen.
La composición incluye bandejas estándar.
Grifo excluido.

		Con piedi / On feet Sur pieds / Mit Füßen / Con patas		Basamento / Base units / Bases / Sockel / Bases		
		Maniglia Handle / Poignée Griff / Tirador	Push-Pull	Maniglia Handle / Poignée Griff / Tirador	Push-Pull	
1	Piano in laminato Fenix® "Fenix®" - laminate worktop / Plan de travail en laminé "Fenix®" Arbeitsplatte aus Laminat "Fenix®" / Encimera de laminado "Fenix®"	+ V2S	€ 9.417,00	€ 9.607,00	€ 8.943,00	€ 9.133,00
2	Piano in stratificato Stratified top / Plan stratifié / Arbeitsplatte aus Schichtstoff / Encimera de estratificado	+ V2S	€ 10.443,00	€ 10.631,00	€ 9.970,00	€ 10.158,00
3	Piano in acciaio inox Steel top / Plan en acier Arbeitsplatte aus stahl / Encimera de acero	+ V11 + VAA	€ 11.355,00	€ 11.545,00	€ 10.881,00	€ 11.071,00
4	Piano in Corian® Corian® top / Plan en Corian® Arbeitsplatte aus Corian® / Encimera de Corian®	+ VPC	€ 11.931,00	€ 12.121,00	€ 11.457,00	€ 11.647,00

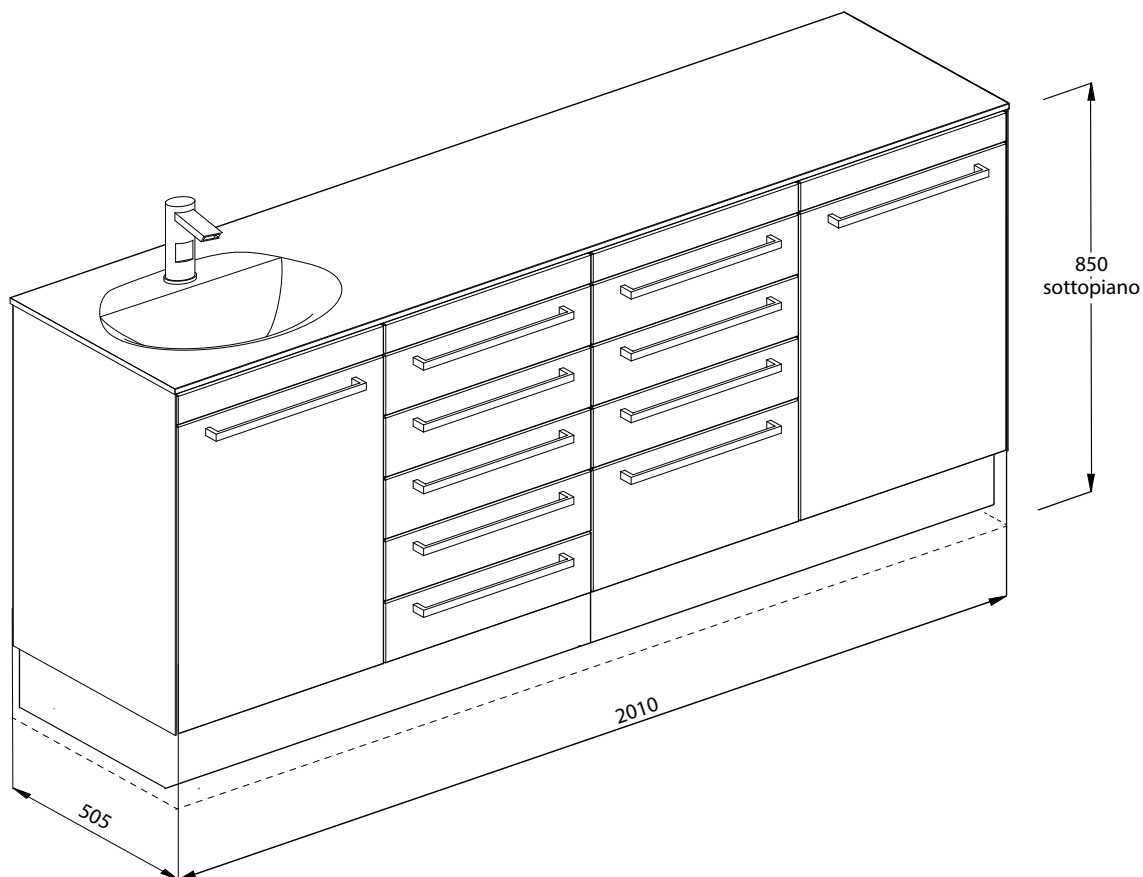

E

COMPOSIZIONE / COMPOSITION / COMPOSITION
ZUSAMMENSTELLUNG / COMPOSICIÓN

PLA+P5B+P4C+PPA

La composizione è comprensiva di bacinelle standard. Rubinetto escluso.

Trays included. Mixer excluded.
Intérieurs de tiroirs inclus. Robinet pas compris.
Standard Schubladeneinsätze sind enthalten. Armatur ist ausgeschlossen.
La composición incluye bandejas estándar.
Grifo excluido.

		Sospesa / Suspended / Suspendue Wandhängend / Suspendida		Basamento / Base units / Bases / Sockel / Bases		
		Maniglia Handle / Poignée Griff / Tirador	Push-Pull	Maniglia Handle / Poignée Griff / Tirador	Push-Pull	
1	Piano in laminato Fenix® "Fenix®" - laminate worktop / Plan de travail en laminé "Fenix®" / Arbeitsplatte aus Laminat "Fenix®" / Encimera de laminado "Fenix®"	+VCF	€ 3.904,00	€ 4.057,00	€ 3.961,00	€ 4.113,00
2	Piano in stratificato Stratified top / Plan stratifié / Arbeitsplatte aus Schichtstoff / Encimera de estratificado	+VCS	€ 4.515,00	€ 4.665,00	€ 4.572,00	€ 4.722,00
3	Piano in Corian® Corian® top / Plan en Corian® Arbeitsplatte aus Corian® / Encimera de Corian®	+VTC	€ 5.004,00	€ 5.155,00	€ 5.060,00	€ 5.212,00

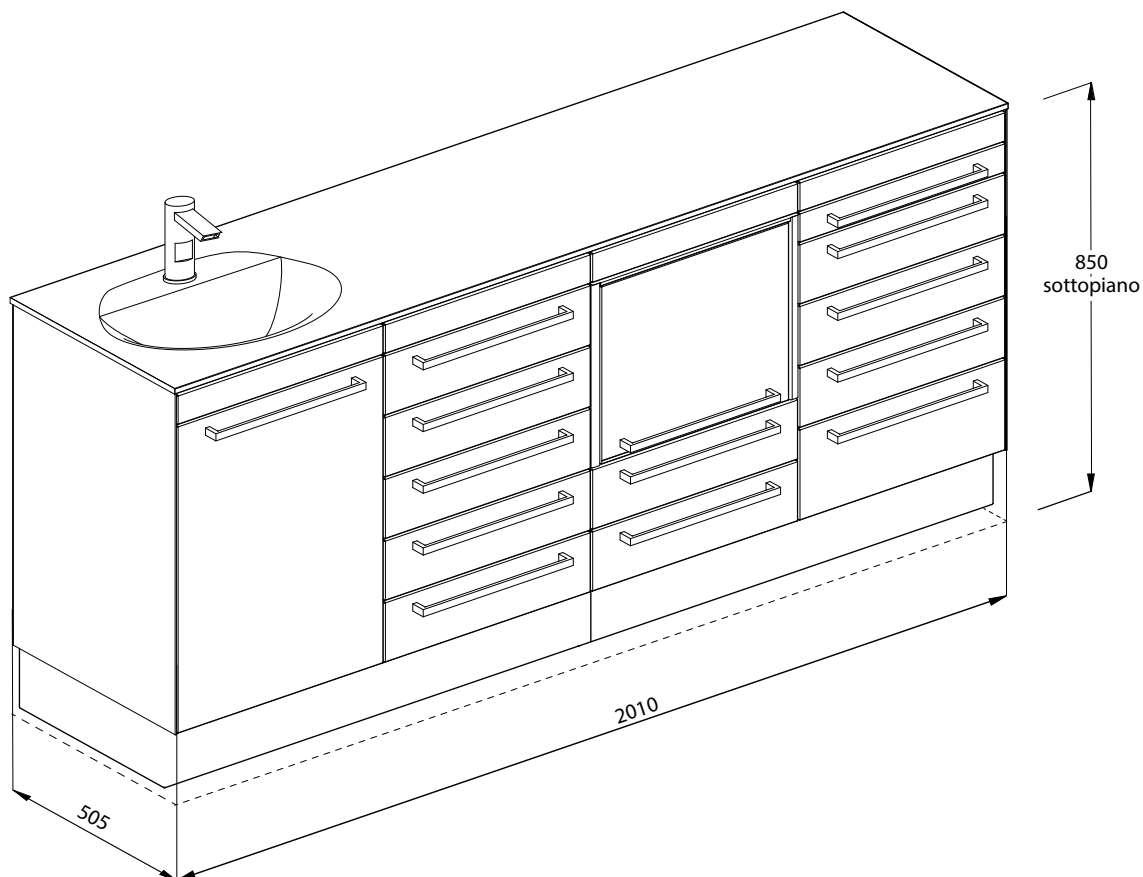

F

**COMPOSIZIONE / COMPOSITION / COMPOSITION
ZUSAMMENSTELLUNG / COMPOSICIÓN**

PLA+P5B+PRA+P5A

**La composizione è comprensiva di bacinelle standard.
Rubinetto escluso.**

Trays included. Mixer excluded

Intérieurs de tiroirs inclus. Robinet pas compris.

Standard Schubladeneinsätze sind enthalten. Armatur ist ausgeschlossen.

La composición incluye bandejas estándar.

Grifo excluido.

		Sospesa / Suspended / Suspendue Wandhängend / Suspendida		Basamento / Base units / Bases / Sockel / Bases		
		Maniglia Handle / Poignée Griff / Tirador	Push-Pull	Maniglia Handle / Poignée Griff / Tirador	Push-Pull	
1	Piano in laminato Fenix® "Fenix®" - laminate worktop / Plan de travail en laminé "Fenix®" / Arbeitsplatte aus Laminat "Fenix®" / Encimera de laminado "Fenix®"	+VCF	€ 4.871,00	€ 5.057,00	€ 4.927,00	€ 5.113,00
2	Piano in stratificato Stratified top / Plan stratifié / Arbeitsplatte aus Schichtstoff / Encimera de estratificado	+VCS	€ 5.482,00	€ 5.667,00	€ 5.539,00	€ 5.724,00
3	Piano in Corian® Corian® top / Plan en Corian® Arbeitsplatte aus Corian® / Encimera de Corian®	+VTC	€ 5.969,00	€ 6.155,00	€ 6.026,00	€ 6.212,00

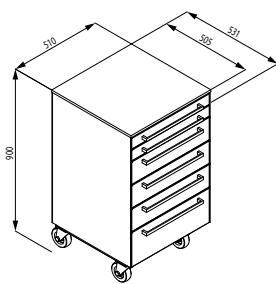
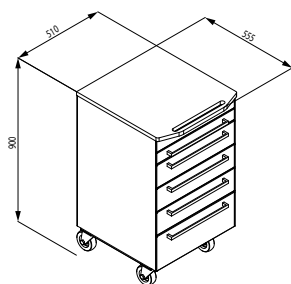

G

SERVOMOBILE / COMPOSITION / COMPOSITION
ZUSAMMENSTELLUNG / COMPOSICIÓN

P5A + KRP

Il servomobile è comprensivo di bacinelle standard.

Trays included.
Intérieurs de tiroirs inclus.
Standard Schubladeneinsätze sind enthalten.
La composición incluye bandejas estándar.

	Maniglia Handle / Poignée Griff / Tirador	Push-Pull
1 Piano in stratificato Stratified top / Plan stratifié / Arbeitsplatte aus Schichtstoff / Encimera de estratificado	€ 1.378,00	€ 1.435,00
2 Piano in vetro Glass top / Plan en verre Arbeitsplatte aus Glas / Encimera de vidrio	€ 1.524,00	€ 1.582,00
3 Piano in Corian® Corian® top / Plan en Corian® Arbeitsplatte aus Corian® / Encimera de Corian®	€ 1.438,00	€ 1.496,00
4 Piano in acciaio inox Steel top / Plan en acier Arbeitsplatte aus stahl / Encimera de acero	€ 1.508,00	€ 1.566,00

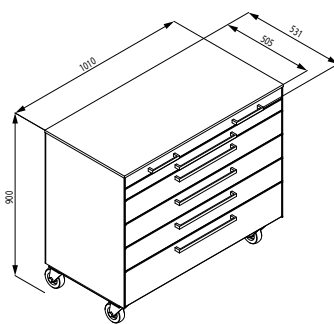
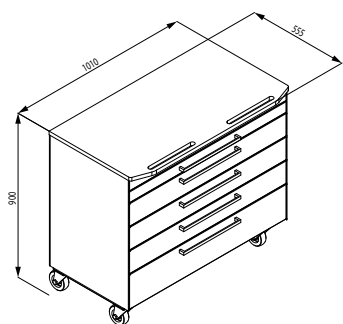

H

SERVOMOBILE / COMPOSITION / COMPOSITION
ZUSAMMENSTELLUNG / COMPOSICIÓN

P5A_2 + KRP_2

Il servomobile è comprensivo di bacinelle standard.

Trays included.
Intérieurs de tiroirs inclus.
Standard Schubladeneinsätze sind enthalten.
La composición incluye bandejas estándar.

	Maniglia Handle / Poignée Griff / Tirador	Push-Pull
1 Piano in stratificato Stratified top / Plan stratifié / Arbeitsplatte aus Schichtstoff / Encimera de estratificado	€ 2.211,00	€ 2.330,00
2 Piano in vetro Glass top / Plan en verre Arbeitsplatte aus Glas / Encimera de vidrio	€ 2.293,00	€ 2.412,00
3 Piano in Corian® Corian® top / Plan en Corian® Arbeitsplatte aus Corian® / Encimera de Corian®	€ 2.273,00	€ 2.392,00
4 Piano in acciaio inox Steel top / Plan en acier Arbeitsplatte aus stahl / Encimera de acero	€ 2.481,00	€ 2.600,00

MODULI

Aggiungere ad ogni elemento il prezzo del supporto a pavimento o del basamento e relativi fianchi laterali dove necessari, del piano, dell'alzatina, del lavello e del rubinetto.

(Il sottopiano è già incluso nei moduli).

I moduli su misura possono essere realizzati solo con anta: applicare il prezzo dell'articolo di misura superiore con un supplemento del **35%**.

ATTENZIONE

Indicare sempre le misure delle apparecchiature che devono essere inserite nei moduli.

Le composizioni si intendono sempre a partire da sinistra verso destra.

Dimensioni: L = Larghezza P = Profondità H = Altezza

COLORI

Bianco Loran per i frontali, i fianchi di finitura, sottopiani e i basamenti.

Specificare dimensioni e tipo di piano, alzatina, lavello e rubinetto.

Per composizioni con elementi ad angolo verificare la perpendicolarità delle pareti (90°): considerando la distanza di 80 cm su una parete e 60 cm sull'altra, la diagonale deve corrispondere a 100 cm.

MANIGLIE ALLUMINIO

N.B.: solo in alluminio, **NO** verniciate.

SUPPORTI A PAVIMENTO

N.B.: solo verniciati Bianco Loran.

STRATIFICATO E LAMINATO

Solo di colore bianco.

SPESE IMBALLO

Ogni collo € 20,00 prezzo netto.

UNITS

Add the floor support or base and sides price, the top, splashback, sink and mixer prices to each unit.

(Undercounter included).

Made-to-measure units: apply the price of the article with the next greater size and add a **35%** extra charge.

ATTENTION

Always provide the dimensions of the appliances that will be built into the units.

The compositions are always understood as starting from the left to the right.

Dimensions:

L = Width P = Depth H = Height

COLORS

Bianco Loran / White Loran for sides and fronts, sides, undercounter and bases.

Specify the dimensions and type of top, splashback, sink and mixer.

For compositions with corner elements check that the walls are perfectly perpendicular (90°): considering the distance of 80 cm on the right and 60 cm left hand sides of the corner, the diagonal line must be 100 cm.

ALUMINIUM HANDLE

Attention: only aluminium, **NOT** painted.

FLOOR SUPPORT

Attention: only painted White Loran.

STRATIFIED and LAMINATE

only in white color.

PACKING COSTS

Each package € 20,00 net price.

MODULES

À chaque module il faut ajouter le prix de: support au sol, base et cotés, plan, dossier, évier et robinet.

(Sous plan inclus).

Les modules sur mesure peuvent être réalisés uniquement avec une porte: appliquer le prix de l'article de mesure supérieure et ajouter un supplément de **35%**.

ATTENTION

Indiquer obligatoirement les mesures exactes des appareils destinés à être introduits dans les meubles.

Les compositions s'entendent toujours en partant de gauche vers la droite.

Dimensions:

L = Largeur P = Profondeur H = Hauteur

COULEURS

Blanc Loran pour les côtés, les façades, sous plan et les bases.

Spécifier les dimensions et le type du plan, du dossier, du lavabo et du robinet. Pour les compositions avec des éléments d'angle, contrôler soigneusement la perpendicularité des murs (90°): si on prend la distance exacte de 80 cm à droite et 60 cm à gauche de l'angle, la diagonale devra mesurer 100 cm

POIGNÉE EN ALUMINIUM

Attention: en aluminium, **PAS** peint.

SUPPORTS AU SOL

Attention: seulement peint Loran Blanc.

STRATIFIÉ et LAMINÉ

en couleur blanc seulement.

FRAIS D'EMBALLAGE

Prix net de chaque colis € 20,00.

SCHRÄNKE

Bei jedem Element muss der Preis der Bodengestell, Wandbefestigung, Sockel und Seiten der Arbeitsplatte, der Aufkantung, der Spüle und der Wasserhahn separat berechnet werden.

(Unterbaus enthalten).

Maßgefertigte Schränke können nur mit Tür hergestellt werden: auf den Preis des nächst größeren Artikels einen Mehrpreis von **35%** berechnen.

VORSICHT

Immer die Maße der Geräte angeben, die in die Schränke eingebaut werden.

Die Anbaulösungen sind immer von links nach rechts angegeben.

Abmessungen:

L = Breite P = Tief H = Höhe

FARBEN

Loran Weiss für Seiten, Fronten, Unterbau und Sockel.

Abmessungen und Art der Arbeitsplatte, Aufkantung, Spüle und Wasserhahn angeben.

Bei Anbaulösungen mit ECKelementen auf lotrechte (90°) Wände achten: bei einem Abstand von 80 cm rechts und 60 cm links von der Ecke muss die Diagonale 100 cm betragen.

ALUMINIUMGRIFF

Bitte beachten: Aluminium, **NICHT** lackiert.

BODENGESTELL

Bitte beachten: nur gemalt Weißer Loran.

SCHICHTSTOFF und LAMINAT

Nur weiß.

VERPACKUNGSKOSTEN

Jedes Paket € 20,00 Nettopreis.

MÓDULOS

Añadir a cada elemento el precio del soporte en pared, de la base y de los paneles laterales, de la encimera, de la alzada, del lavabo y del grifo.

(Pieza debajo de la encimera incluida).

Los muebles a la medida pueden realizarse sólo con la puerta: aplicar el precio del artículo de medida superior con un recargo del **35%**.

ATENCIÓN

Indicar siempre las medidas de los equipos que deben introducirse en los módulos.

Las composiciones se consideran siempre a partir de la izquierda hacia la derecha.

Dimensiones:

L = Ancho P = Profundidad H = Alto

COLORES ESTANDAR:

Blanco Loran para los paneles laterales, los frentes, de baio de la encimera y las bases.

Especificar las dimensiones y el tipo de encimera, de alzada, de lavabo y de grifo. Para composiciones con elementos en ángulo controlar la perpendicularidad de las paredes (90°): considerando la distancia de 80 cm a la dcha. y 60 cm a la izq.. del ángulo, la diagonal debe corresponder a 100 cm.

TIRADOR DE ALUMINIO

Atención: en aluminio, **NO** pintada.

SOPORTE DE PIE

Atención: solo pintado Loran blanco.

ESTRATIFICADO y LAMINADO

De color blanco.

EMBALAJE

Cada paquete € 20,00 precio neto.

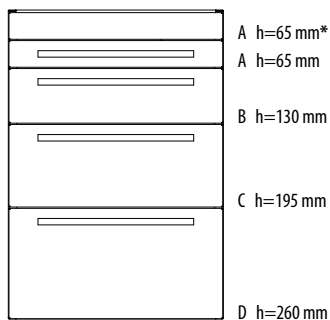
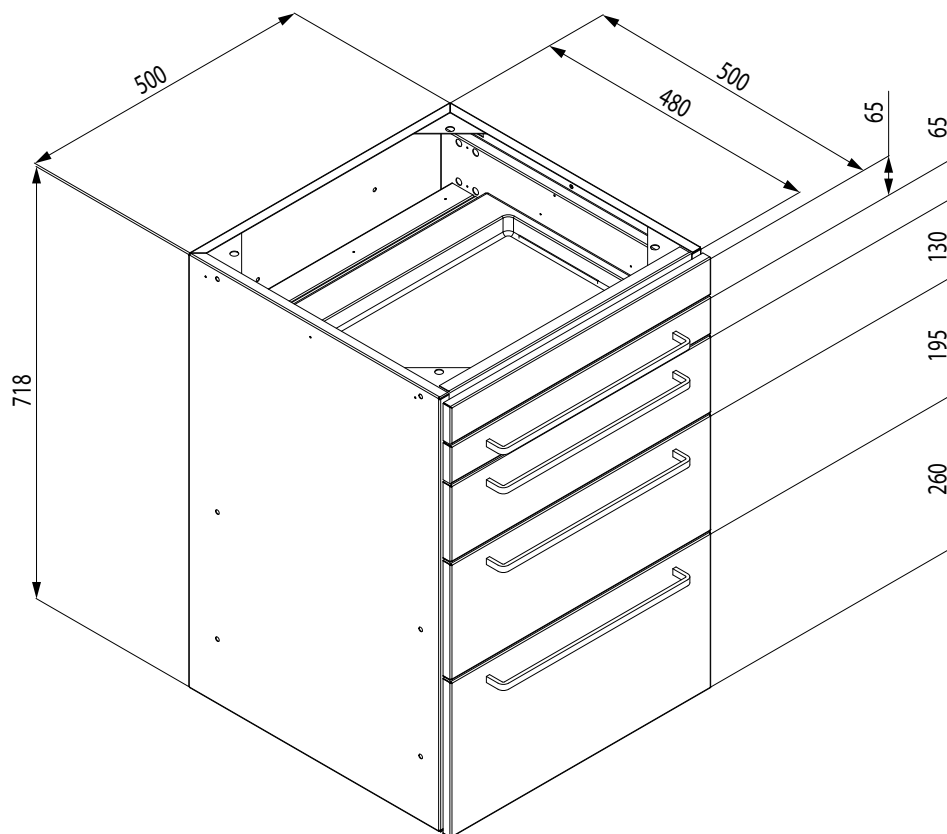

Cassetti
Drawers / Tiroirs
Schubladen / Cajones

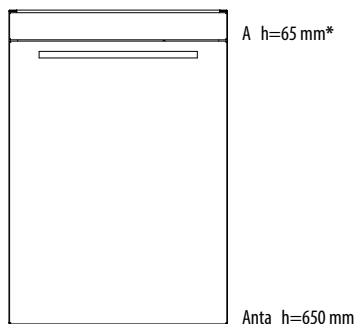

Anta
Door / Porte
Tür / Puerta

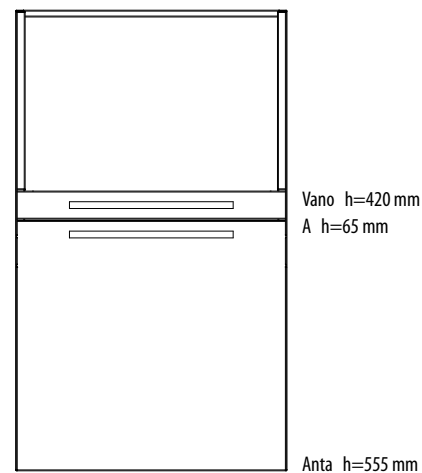

Modulo per termosigillatrice
Lowered module for autoclave
Module surbaissé pour autoclave
Gesenktes Modul für Autoklav
Módulo bajo para autoclave

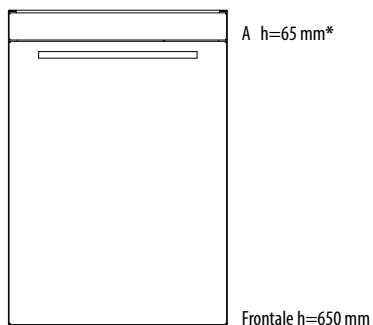

Cassettone
Pullout drawer / Grand tiroir
Oder schublade / Cajon

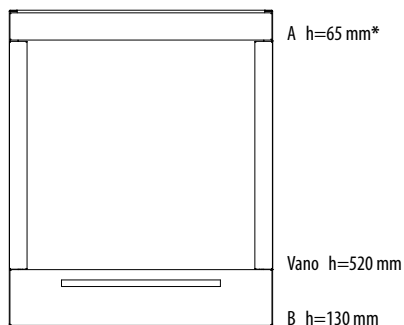

Modulo per autoclave
Module for autoclave / Module pour autoclave
Modul für Autoklav / Módulo para autoclave

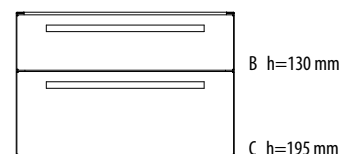

Modulo per termosigillatrice
Module for thermosigilator / Module pour thermoscelluse / Modul für Wärmeversiegelung / Módulo para termoselladora

* Frontale A fisso (possibilità di sostituzione con cassetto estraibile) / Fixed A front panel (possibility of replacement with pull-out shelf) / Façade A fixe (possibilité de la remplacer par un tiroir extractible) / Feststehende Frontseite A (austauschbar mit ausziehbarer Schublade) / Frente A fijo (posibilidad de sustitución con cajón extraíble)

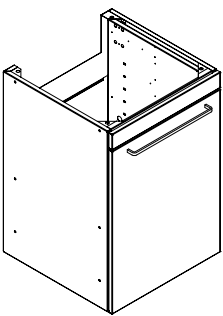
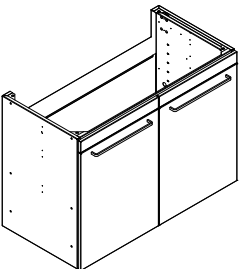
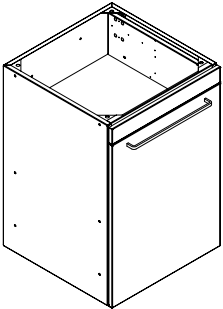
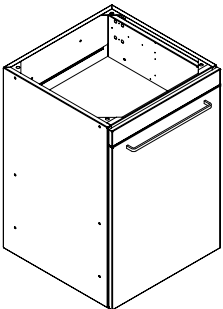
	Descrizione / Description Description / Beschreibung / Descripción	Apertura Opening / Ouverture Öffnung / Apertura	M ³ Kg	Articolo Item / Article Artikel / Artículo	Prezzo Price / Prix Preis / Precio
 <p>MODULO sottolavello con anta "SLA" o con cassettone estraibile "SLC", con portarifiuti interno</p> <p>Sink module with "SLA" door or "SLC" pullout drawer, with internal waste bin</p> <p>Module évier avec porte "SLA" ou avec bac extractible "SLC", avec poubelle intérieure</p> <p>Unterwaschbecken-Modul mit Tür "SLA" oder ausziehbarer Schublade "SLC", mit Innenabfallbehälter</p> <p>Módulo debajo del lavabo con hoja "SLA" o con cajón extraíble "SLC", con cubo de basura interior</p> <p>L 500 x P 500 x H 718 mm</p>		Maniglia Handle Poignée Griff Tirador	0,17 27,7	SLAM	€ 399,00
			0,17 32,2	SLCM	€ 563,00
			0,17 27,5	SLAP	€ 431,00
	Push-Pull		0,17 32	SLCP	€ 587,00
 <p>MODULO sottolavello L 1000 mm con 2 ante e portarifiuti interno</p> <p>Sink module sink L 1000 mm with 2 doors and internal waste bin</p> <p>Module évier L 1000 mm avec 2 portes et poubelle intérieure</p> <p>Unterwaschbecken-Modul L 1000 mm mit 2 Türen und Innenabfallbehälter</p> <p>Módulo debajo del lavabo L 1000 mm con 2 hojas y cubo de basura interior</p> <p>L 1000 x P 500 x H 718 mm</p>		Maniglia Handle Poignée Griff Tirador	0,36 48,4	SLLM	€ 782,00
	Push-Pull		0,36 48	SLLP	€ 865,00
 <p>MODULO con anta e due ripiani interni</p> <p>Unit with door and 2 interior shelves</p> <p>Module avec porte et 2 étagères internes</p> <p>Schrank mit Tür und 2 Einlegeböden</p> <p>Módulo con puerta y dos estantes interiores</p> <p>L 500 x P 500 x H 718 mm L 600 x P 500 x H 718 mm</p>		Maniglia Handle Poignée Griff Tirador	0,17 26,5	SPAM (L. 500 mm)	€ 388,00
			0,22 30,5	SPMM (L. 600 mm)	€ 398,00
 <p>MODULO schiena aperta, con anta e due ripiani interni</p> <p>Open back module, with door and two internal shelves</p> <p>Module ouvert derrière, avec porte et deux étagères intérieures</p> <p>Modul hinten offen, mit Tür und zwei Einlegeböden</p> <p>Módulo sin paneles, con hoja y dos estantes interiores</p> <p>L 500 x P 500 x H 718 mm L 600 x P 500 x H 718 mm</p>		Maniglia Handle Poignée Griff Tirador	0,17 24,3	SPFM (L. 500 mm)	€ 388,00
			0,22 28,3	SPNM (L. 600 mm)	€ 398,00

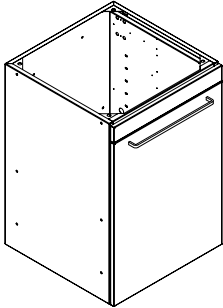
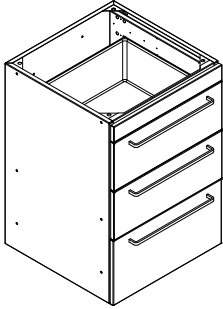
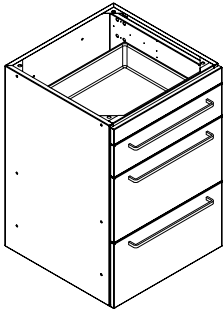
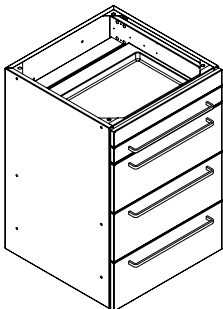
	Descrizione / Description Description / Beschreibung / Descripción	Apertura Opening / Ouverture Öffnung / Apertura	M ³ Kg	Articolo Item / Article Artikel / Artículo	Prezzo Price / Prix Preis / Precio
 <p>MODULO con anta senza ripiani "SPI" o con cassettone estraibile con 2 portarifiuti "SPC" Module with "SPI" door without shelves or "SPC" large pull-out drawer with 2 waste bins Module avec porte "SPI" sans étagères ou avec bac extractible avec 2 poubelles "SPC" Modul mit Tür "SPI" ohne Einlegeböden "SPI" oder mit ausziehbarer Schublade mit 2 Abfallbehältern "SPC" Módulo con hoja sin estantes "SPI" o con cajón extraíble con 2 cubos de basura "SPC"</p> <p>L 500 x P 500 x H 718 mm</p>			0,17 26,5	SPIM	€ 313,00
	Anta Door/Porte Tür/Puerta	0,17 26,3	SPIP	€ 336,00	
	Cassettone Drawer/Tiroir Schublade Cajon	0,17 39	SPCM	€ 651,00	
		0,17 38,8	SPCP	€ 675,00	
 <p>MODULO con 3 cassetti: 2 C e 1 D Unit with 3 drawers: 2 C and 1 D Module avec 3 tiroirs: 2 C et 1 D Schrank mit 3 Schubladen: 2 C et 1 D Módulo con 3 cajones: 2 C y 1 D</p> <p>Bacinnelle / Trays / Intérieurs de tiroir Einsätze / Bandejas: 3xLBC1</p> <p>L 500 x P 500 x H 718 mm</p>					
	Maniglia Handle Poignée Griff Tirador	0,17 40	S3AM	€ 639,00	
 <p>MODULO con 3 cassetti: 1 B e 2 D Unit with 3 drawers: 1 B and 2 D Module avec 3 tiroirs: 1 B et 2 D Schrank mit 3 Schubladen: 1 B et 2 D Módulo con 3 cajones: 1 B y 2 D</p> <p>Bacinnelle / Trays / Intérieurs de tiroir Einsätze / Bandejas: 1xLBB1, 2xLBC1</p> <p>L 500 x P 500 x H 718 mm</p>					
	Maniglia Handle Poignée Griff Tirador	0,17 40,2	S3BM	€ 664,00	
 <p>MODULO con 4 cassetti: 1 A e 3 C Unit with 4 drawers: 1 A and 3 C Module avec 4 tiroirs: 1 A et 3 C Schrank mit 4 Schubladen: 1 A et 3 C Módulo con 4 cajones: 1 A y 3 C</p> <p>Bacinnelle / Trays / Intérieurs de tiroir Einsätze / Bandejas: 1xLBA2, 3xLBC1</p> <p>L 500 x P 500 x H 718 mm</p>					
	Maniglia Handle Poignée Griff Tirador	0,17 43,7	S4AM	€ 704,00	

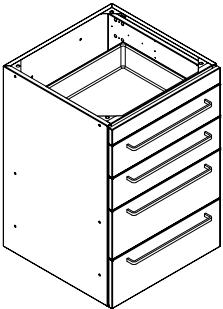
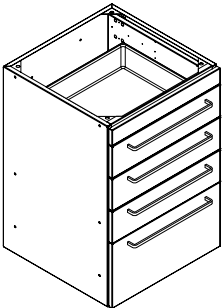
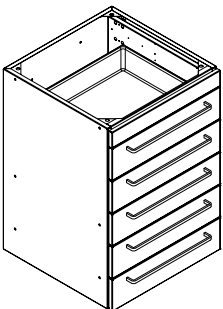
	Descrizione / Description Description / Beschreibung / Descripción	Apertura Opening / Ouverture Öffnung / Apertura	M ³ Kg	Articolo Item / Article Artikel / Artículo	Prezzo Price / Prix Preis / Precio
 <p>MODULO con 4 cassetti: 2 B e 2 C Unit with 4 drawers: 2 B and 2 C Module avec 4 tiroirs: 2 B et 2 C Schrank mit 4 Schubladen: 2 B et 2 C Módulo con 4 cajones: 2 B y 2 C</p> <p>Bacinelle / Trays / Intérieurs de tiroir Einsätze / Bandejas: 1xLBB1, 1xLBB2, 2xLBC1</p> <p>L 500 x P 500 x H 718 mm</p>	<p>Maniglia Handle Poignée Griff Tirador</p>	<p>0,17 44,3</p>	S4BM	€ 704,00	
 <p>MODULO con 4 cassetti: 3 B e 1 D Unit with 4 drawers: 3 B and 1 D Module avec 4 tiroirs: 3 B et 1 D Schrank mit 4 Schubladen: 3 B et 1 D Módulo con 4 cajones: 3 B y 1 D</p> <p>Bacinelle / Trays / Intérieurs de tiroir Einsätze / Bandejas: 1xLBB1, 1xLBB2, 1xLBB3, 1xLBC1</p> <p>L 500 x P 500 x H 718 mm</p>	<p>Maniglia Handle Poignée Griff Tirador</p>	<p>0,17 38,5</p>	S4CM	€ 735,00	
 <p>MODULO con 5 cassetti: 1 A, 3 B e 1 C Unit with 5 drawers: 1 A, 3 B and 1 C Module avec 5 tiroirs: 1 A, 3 B et 1 C Schrank mit 5 Schubladen: 1 A, 3 B et 1 C Módulo con 5 cajones: 1 A, 3 B y 1 C</p> <p>Bacinelle / Trays / Intérieurs de tiroir Einsätze / Bandejas: 1xLBA2, 1xLBB1, 1xLBB2, 1xLBB3, 1xLBC1</p> <p>L 500 x P 500 x H 718 mm</p>	<p>Maniglia Handle Poignée Griff Tirador</p>	<p>0,17 48,2</p>	S5AM	€ 753,00	
 <p>MODULO con 5 cassetti: 5 B Unit with 5 drawers: 5 B Module avec 5 tiroirs: 5 B Schrank mit 5 Schubladen: 5 B Módulo con 5 cajones: 5 B</p> <p>Bacinelle / Trays / Intérieurs de tiroir Einsätze / Bandejas: 3xLBB1, 1xLBB2, 1xLBB3</p> <p>L 500 x P 500 x H 718 mm</p>	<p>Maniglia Handle Poignée Griff Tirador</p>	<p>0,17 48,9</p>	S5BM	€ 750,00	

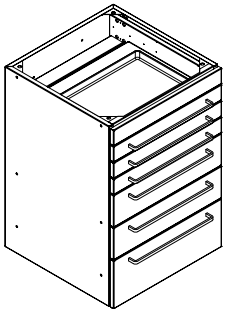
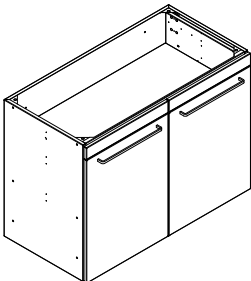
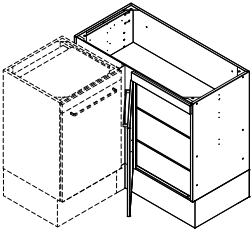
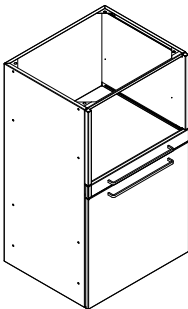
	Descrizione / Description Description / Beschreibung / Descripción	Apertura Opening / Ouverture Öffnung / Apertura	M ³ Kg	Articolo Item / Article Artikel / Artículo	Prezzo Price / Prix Preis / Precio
	<p>MODULO con 6 cassetti: 3 A, 2 B e 1 C</p> <p>Unit with 6 drawers: 3 A, 2 B and 1 C Module avec 6 tiroirs: 3 A, 2 B et 1 C Schrank mit 6 Schubladen: 3 A, 2 B et 1 C Módulo con 6 cajones: 3 A, 2 B y 1 C</p> <p>Bacinelle / Trays / Intérieurs de tiroir Einsätze / Bandejas: 1xLBA1, 1xLBA2, 1xLBA3, 1xLBB1, 1xLBB3, 1xLBC1</p>	Maniglia Handle Poignée Griff Tirador	0,17 51,6	S6AM	€ 803,00
	<p>MODULO da 1000 mm con 2 ante e 2 ripiani interni</p> <p>1000 mm module with 2 doors and 2 internal shelves Module de 1000 mm avec 2 portes et 2 étagères intérieures Modul 1000 mm, mit 2 Türen und 2 Inneneinlegeböden Módulo de 1000 mm con 2 hojas y 2 estantes interiores</p>	Maniglia Handle Poignée Griff Tirador	0,36 46	SPLM	€ 614,00
	<p>MODULO angolare con 2 ripiani interni</p> <p>Angular module with 2 internal shelves Module d'angle avec 2 étagères intérieures Eckmodul mit 2 Inneneinlegeböden Módulo angular con 2 estantes internos</p>	Maniglia Handle Poignée Griff Tirador	0,36 40	SPOM (Door on the right)	€ 716,00
		Maniglia Handle Poignée Griff Tirador	0,36 40	SPRM (Door on the left)	€ 716,00
	<p>MODULO per termosigillatrice con ante e predisposizione per autoclave sopra il piano (piano escluso)</p> <p>Thermosealer module with H 430 mm compartment and drawer, door and shelf in the lower compartment, top prepared for autoclave (top not included) Module soudeuse avec logement H 430 mm et tiroir, porte et étagère en bas, dessus préparé pour autoclave (plan de travail non inclus) Modul für Wärmeversiegelung mit Tür und Vorrichtung für Autoklav auf der Ebene (Ebene nicht inkl.) Módulo termoselladora con alojamiento H 430 mm y cajón, puerta y estante inferior, parte superior preparada para autoclave (encimera no incluida)</p>	Maniglia Handle Poignée Griff Tirador	0,3 38	STAM	€ 846,00

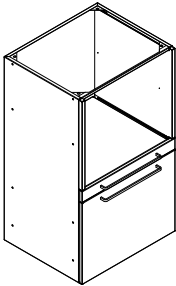
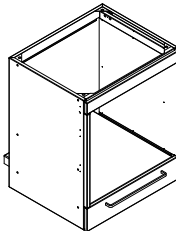
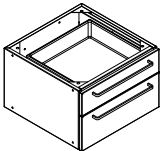
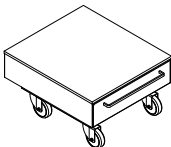
	Descrizione / Description Description / Beschreibung / Descripción	Apertura Opening / Ouverture Öffnung / Apertura	M³ Kg	Articolo Item / Article Artikel / Artículo	Prezzo Price / Prix Preis / Precio
	<p>MODULO per autoclave con vano H 520 e anta nella parte inferiore</p> <p>MODULE for autoclave with H 520 compartment and door in the lower part</p> <p>MODULE pour autoclave avec logement H 520 et porte dans la partie inférieure</p> <p>MODUL für Autoklav mit Fach H 520 und Tür im unteren Teil</p> <p>MÓDULO para autoclave con compartimento H 520 y puerta en la parte inferior</p>	Maniglia Handle Poignée Griff Tirador	<u>0,3</u> 38	SAFM	€ 846,00
L 600 x P 500 x H 1065 mm					
	<p>MODULO per autoclave</p> <p>Module for autoclave</p> <p>Module pour autoclave</p> <p>Modul für Autoklav</p> <p>Módulo para autoclave</p>	Maniglia Handle Poignée Griff Tirador	<u>0,21</u> 23	SAAM	€ 602,00
L 600 x P 500 x H 718 mm					
	<p>MODULO ribassato per autoclave o Multisteril con cassetti: 1 B e 1 C</p> <p>Lowered module for autoclave or Multisteril with drawers: 1 B and 1 C</p> <p>Module surbaissé pour autoclave ou multisteril avec tiroirs: 1 B et 1 C</p> <p>Gesenktes Modul für Autoklav oder Multisteril mit Schubladen: 1 B und 1 C</p> <p>Módulo bajo para autoclave o multisteril con cajones: 1 B y 1 C</p>	Maniglia Handle Poignée Griff Tirador	<u>0,8</u> 18	SABM	€ 576,00
L 500 x P 500 x H 328 mm	Bacinelle / Trays / Intérieurs de tiroir Einsätze / Bandejas: 1xLBB1, 1xLBC1				
	<p>CARRELLO porta autoclave con 1 cassetto B e piano in stratificato</p> <p>Autoclave-holder trolley with 1 B drawer and laminated top</p> <p>Chariot porte autoclave avec 1 tiroir B et un plan en stratifié</p> <p>Wagen für Autoklav mit 1 Schublade B und Ebene aus Verbundmaterial</p> <p>Carro porta autoclave con 1 cajón B y encimera de estratificado</p>	Maniglia Handle Poignée Griff Tirador	<u>0,1</u> 26,1	SACM	€ 694,00
L 510 x P 565 x H 310 mm	Bacinelle / Trays / Intérieurs de tiroir Einsätze / Bandejas: 1xLBA2				

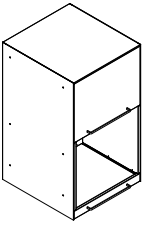
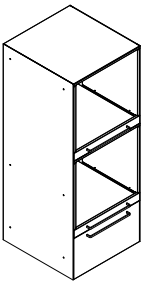
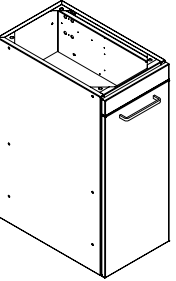
	Descrizione / Description Description / Beschreibung / Descripción	Apertura Opening / Ouverture Öffnung / Apertura	M ³ Kg	Articolo Item / Article Artikel / Artículo	Prezzo Price / Prix Preis / Precio
 <p>L 606 x P 640 x H 1068 mm</p>	<p>Colonne con 1 vano per autoclave e anta, da posizionare soprapiano "SADM" o con 2 vani per autoclave e anta, da posizionare a terra "SAGM"</p> <p>Columns with 1 compartment for autoclave and door, to be positioned on the "SADM" top or with 2 compartments for autoclave and door, to be positioned on the "SAGM" ground</p> <p>Colonnes avec 1 logement pour autoclave et porte, à positionner sur le plan de travail "SADM" ou avec 2 logements pour autoclave et porte, à positionner sur le sol "SAGM"</p> <p>Säulen mit 1 Fach für Autoklav und Türflügel, als Aufbaukonstruktion "SADM" oder mit 2 Fächern für Autoklav und Türflügel, zur Bodenplatzierung "SAGM"</p> <p>Columnas con 1 compartimiento para autoclave y puerta, para colocar sobre la encimera "SADM" o con 2 compartimientos para autoclave y puerta, para colocar en el suelo "SAGM"</p>	Maniglia Handle Poignée Griff Tirador	0,3 40	SADM	€ 947,00
		Maniglia Handle Poignée Griff Tirador	0,6 60	SAGM	€ 1.805,00
 <p>L 606 x P 640 x H 1536 mm</p>	<p>MODULO con anta e due ripiani interni</p> <p>Unit with door and 2 interior shelves</p> <p>Module avec porte et 2 étagères internes</p> <p>Schrank mit Tür und 2 Einlegeböden</p> <p>Módulo con puerta y dos estantes interiores</p>	Maniglia Handle Poignée Griff Tirador	0,10 21,5	SPDM (L. 300 mm)	€ 388,00
		Maniglia Handle Poignée Griff Tirador	0,14 24	SPGM (L. 400 mm)	€ 388,00
 <p>L 300 x P 500 x H 718 mm L 400 x P 500 x H 718 mm</p>	<p>MODULO con anta e due ripiani interni, con schiena aperta</p> <p>Unit with door and 2 interior shelves, open back</p> <p>Module avec porte et 2 étagères internes, ouvert derrière</p> <p>Schrank mit Tür und 2 Einlegeböden, Rückwand geöffnet</p> <p>Módulo con puerta y dos estantes interiores, con panel trasero abierto</p>	Maniglia Handle Poignée Griff Tirador	0,10 21	SPEM (L. 300 mm)	€ 388,00
		Maniglia Handle Poignée Griff Tirador	0,14 23,5	SPHM (L. 400 mm)	€ 388,00

VELA

LOOK

LIKE

ALA/QUADRO
NOVO/UPRIGHTMOVINGTRAY
MOVING ARMPURA
PURASTUDIO

STERIL K

CART

ARMADI

BACINELLE

PIANI
ALZATINELAVELLI
RUBINETTILAVORAZIONI
ACCESSORIOPEN BOX
SEGGIOLINI

PROF

MAESTRO

IMPIANTISTICA

STERIL K | Supporti a pavimento

Floor supports / Supports au sol / Bodengestelle / Soportes de pie

LORAN

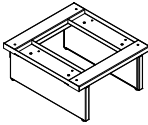
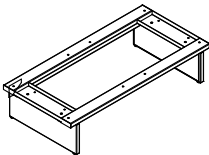
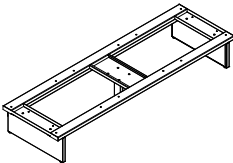
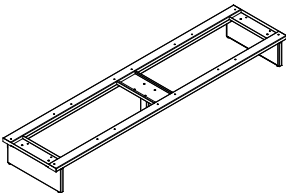
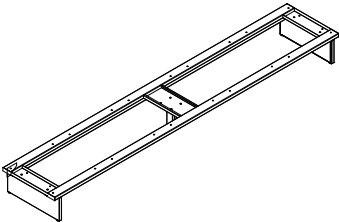
	Descrizione / Description Description / Beschreibung / Descripción	Fianchi Sides / Côtés Seiten / Laterales	M³ Kg	Articolo Item / Article Artikel / Artículo	Prezzo Price / Prix Preis / Precio
 <p>L 500 mm L 600 mm</p>	SUPPORTO a pavimento per 1 modulo Floor support for 1 unit Support au sol pour 1 module Bodengestell für 1 Schrank Soporte de pie para 1 módulo	Verniciato Painted / Verni Lackiert Pintado	0,30	SS05 (L. 500 mm)	€ 196,00
			0,36	SS06 (L. 600 mm)	€ 196,00
 <p>L 1000-1100 mm</p>	SUPPORTO a pavimento per 2 moduli Floor support for 2 units Support au sol pour 2 modules Bodengestell für 2 Schränke Soporte de pie para 2 módulos	Verniciato Painted / Verni Lackiert Pintado	0,59	SS10 (L. 1000 mm)	€ 246,00
			0,65	SS11 (L. 1100 mm)	€ 246,00
 <p>L 1500-1600 mm</p>	SUPPORTO a pavimento per 3 moduli Floor support for 3 units Support au sol pour 3 modules Bodengestell für 3 Schränke Soporte de pie para 3 módulos	Verniciato Painted / Verni Lackiert Pintado	0,89	SS15 (L. 1500 mm)	€ 313,00
			0,95	SS16 (L. 1600 mm)	€ 313,00
 <p>L 2000-2100 mm</p>	SUPPORTO a pavimento per 4 moduli Floor support for 4 units Support au sol pour 4 modules Bodengestell für 4 Schränke Soporte de pie para 4 módulos	Verniciato Painted / Verni Lackiert Pintado	1,18	SS20 (L. 2000 mm)	€ 403,00
			1,24	SS21 (L. 2100 mm)	€ 403,00
 <p>L 2500-2600 mm</p>	SUPPORTO a pavimento per 5 moduli Floor support for 5 units Support au sol pour 5 modules Bodengestell für 5 Schränke Soporte de pie para 5 módulos	Verniciato Painted / Verni Lackiert Pintado	1,48	SS25 (L. 2500 mm)	€ 466,00
			1,54	SS26 (L. 2600 mm)	€ 466,00

VELA

LOOK

LIKE

ALA/QUADRO
NOVO/UPRIGHTMOVINGTRAY
MOVING ARMPURA
PURASTUDIO

STERIL K

CART

ARMADI

BACINELLE

PIANI
ALZATINELAVELLI
RUBINETTILAVORAZIONI
ACCESSORIOPEN BOX
SEGGIOLINI

PROF

MAESTRO

IMPIANTISTICA

STERIL K | Basamenti

Base units / Bases / Sockel / Bases

LORAN

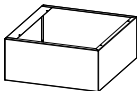
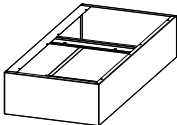
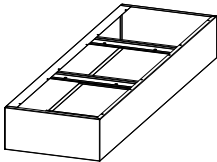
	Descrizione / Description Description / Beschreibung / Descripción	M³ Kg	Articolo Item / Article Artikel / Artículo	Prezzo Price / Prix Preis / Precio
	L 500 x P 445 x H 200 mm Basamento / Base unit / Base Sockel / Base: L 500	$\frac{0,04}{3,5}$	SBK05	€ 85,00
	L 600 x P 445 x H 200 mm Basamento / Base unit / Base Sockel / Base: L 600	$\frac{0,05}{4}$	SBK06	€ 95,00
	L 1000 x P 445 x H 200 mm Basamento / Base unit / Base Sockel / Base: L 1000	$\frac{0,09}{6,5}$	SBK10	€ 127,00
	L 1100 x P 445 x H 200 mm Basamento / Base unit / Base Sockel / Base: L 1100	$\frac{0,09}{7}$	SBK11	€ 137,00
	L 1500 x P 445 x H 200 mm Basamento / Base unit / Base Sockel / Base: L 1500	$\frac{0,13}{12}$	SBK15	€ 208,00
	L 1600 x P 445 x H 200 mm Basamento / Base unit / Base Sockel / Base: L 1600	$\frac{0,14}{12,5}$	SBK16	€ 218,00

VELA

LOOK

LIKE

ALA / QUADRO
NOVO / UPRIGHTMOVINGTRAY
MOVING ARMPURA
PURASTUDIO

STERIL K

CART

ARMADI

BACINELLE

PIANI
ALZATINELAVELLI
RUBINETTILAVORAZIONI
ACCESSORIOPEN BOX
SEGGIOLINI

PROF

MAESTRO

IMPIANTISTICA

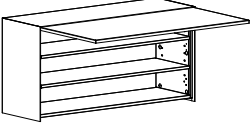
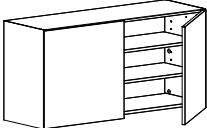
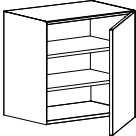
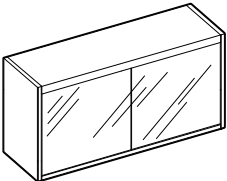
	Descrizione / Description Description / Beschreibung / Descripción	Fianchi Sides / Côtés Seiten / Laterales	M³ Kg	Articolo Item / Article Artikel/Artículo	Prezzo Price / Prix Preis / Precio
	<p>PENSILE L 1000 mm con anta a ribalta verniciata, con 2 ripiani interni</p> <p>Wall unit L 1000 mm with flap painted, with 2 inner shelves</p> <p>Élément haut L 1000 mm avec porte battante peinte, avec 2 étagères intérieures</p> <p>Hängeschrank L 1000 mm mit lackierter Kipptür und 2 Inneneinlegeböden</p> <p>Mueble colgante L 1000 mm con hoja basculante pintada, con 2 estantes internos</p>	Anta verniciata Painted / Verni Lackiert Pintado	0,16 34,5	SV0A	€ 746,00
L 1000 x P 350 x H 500 mm					
	<p>PENSILE L 1000 mm con 2 ante battenti e 2 ripiani interni</p> <p>Cupboard L 1000 mm with 2 doors and 2 internal shelves</p> <p>Élément mural L 1000 mm avec 2 portes battantes et 2 étagères intérieures</p> <p>Hängeschrank L 1000 mm mit 2 Türflügeln und 2 Inneneinlegeböden</p> <p>Mueble colgante L 1000 mm con 2 hojas batientes y 2 estantes interiores</p>	Verniciato Painted / Verni Lackiert Pintado	0,25 34	SV0C	€ 661,00
L 1000 x P 350 x H 500 mm					
	<p>PENSILE L 500 con anta battente e 2 ripiani interni</p> <p>L 500-cupboard with swinging door and 2 interior shelves</p> <p>Élément mural L 500 avec porte battante et 2 étagères internes</p> <p>L 500-Hängeschrank mit Türflügel und 2 Einlegeböden</p> <p>Mueble colgante L 500 con puerta a batiente, con 2 estantes interiores</p>		0,15 21	SV0F	€ 459,00
L 500 x P 350 x H 500 mm					
	<p>VETRINA L 1000 con 2 ripiani interni</p> <p>L 1000-display cabinet with sliding glass doors and 2 interior shelves</p> <p>Vitrine L 1000 avec portes coulissantes et 2 étagères internes</p> <p>L 1000-Vitrine mit Schiebetüren und 2 Einlegeböden</p> <p>Vitrina L 1000 con puertas correderas de cristal, con 2 estantes interiores</p>		0,26 36,5	SV0H	€ 690,00
L 1000 x P 330 x H 482 mm					

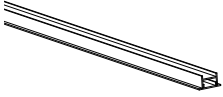
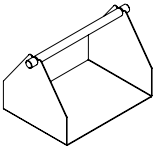
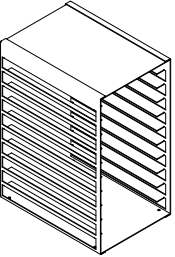
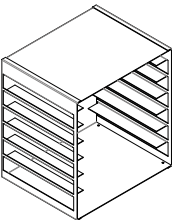
	Descrizione / Description Description / Beschreibung / Descripción	Fianchi Sides / Côtés Seiten / Laterales	M³ Kg	Articolo Item / Article Artikel/Artículo	Prezzo Price / Prix Preis / Precio
	<p>LAMPADA A LED sottopensile/ sottomensola con interruttore touch</p> <p>Under-floor/-shelf LED lamp with touch switch Lampe à LED sous élément haut/sous étagère avec interrupteur tactile LED-lampe für Unterbau Hängeschrank/Regal mit Touch-Schalter Lámpara de LED debajo del mueble colgante/ estante con interruptor táctil</p>		<i>Fino a/Up to</i> L = 500 mm	PLEDE05	€ 201,00
			<i>Fino a/Up to</i> L = 1000 mm	PLEDE10	€ 201,00
	<p>Portarotolo interno al pensile</p> <p>Roll holder inside the cupboard Porte-rouleau intérieur pour élément mural Rollenhalterung für Hängeschrankinnenseite Porta-rollos dentro del mueble colgante</p>		- 2,3	PAP01	€ 107,00
	<p>Porta Tray interno al pensile</p> <p>Tray holder inside the cupboard Porte Tray intérieur pour élément mural Trayhalterung für Hängeschrankinnenseite Porta-Tray dentro del mueble colgante</p> <p>Per 10 trays / For 10 trays / Pour 10 plateaux / Für 10 trays / Para 10 bandejas</p>		- 6,7	PAP02	€ 141,00
	<p>Porta Tubs interno al pensile</p> <p>Tubs holder inside the cupboard Porte Tubs intérieur pour élément mural Tubshalterung für Hängeschrankinnenseite Porta-Tubs dentro del mueble colgante</p> <p>Per 6 tubs / For 6 tubs / Per 6 tubes / Für 6 tubs / Para 6 recipientes</p>		- 7	PAP03	€ 178,00

L 330 x P 210 x H 200 mm

L 203 x P 290 x H 390 mm

L 363 x P 290 x H 390 mm

STERIL K | Barra attrezzata

LORAN

Equipped bar / Barre équipée / Stangenausstattung / Barra equipada

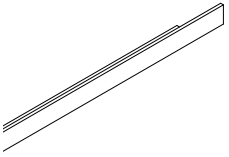
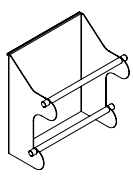
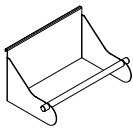
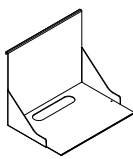
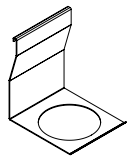
	Descrizione / Description Description / Beschreibung / Descripción	M³ Kg	Articolo Item / Article Artikel / Artículo	Prezzo Price / Prix Preis / Precio
	<p>Barra attrezzata in acciaio inox: al metro lineare</p> <p>Equipped bar in stainless steel: per meter Barre équipée en acier inox: au mètre Edelstahl - Stangenausstattung: meterweise Barra equipada de acero inoxidable: por metro</p>	3 Kg/m	PA01	€/m 132,00
SP 15 x H 50 mm				
	<p>Portarotolo da esterno in acciaio inox</p> <p>Roll holder for exterior in stainless steel Porte-rouleau extérieur en acier inox Edelstahl-Rollenhalterung für außen Porta-rollos para exterior de acero inoxidable</p>	- 4,5	PA02	€ 230,00
L 386 mm x P 250 x H 400 mm				
	<p>Portarotolo da esterno singolo in acciaio inox</p> <p>Single roll holder for exterior in stainless steel Porte-rouleau simple extérieur en acier inox Einzelner Edelstahl-Rollenhalterung für außen Porta-rollos individual para exterior de acero inoxidable</p>	- 3	PA06	€ 210,00
L 386 mm x P 250 x H 200 mm				
	<p>Supporto per attrezzature in acciaio inox</p> <p>Support for equipments in stainless steel Support pour équipements en acier inox Edelstahl-Halterung für Geräte Soporte para equipos de acero inoxidable</p>	- 3,7	PA03	€ 189,00
L 350 mm x P 270 x H 300 mm				
	<p>Supporto per contenitore aghi in acciaio inox (foro ø 130 mm)</p> <p>Support for needle container in stainless steel (hole ø 130 mm) Support pour conteneur à aiguilles en acier inox (trou ø 130 mm) Halterung für Nadelbehälter aus Edelstahl (Bohrung ø 130 mm) Soporte para contenedor agujas de acero inoxidable (orificio ø 130 mm)</p>	- 0,9	PA04	€ 107,00
L 160 mm x P 170 x H 210 mm				

VELA

LOOK

LIKE

ALA/QUADRO
NOVO/UPRIGHTMOVINGTRAY
MOVING ARMPURRA
PURASTUDIO

STERIL K

CART

ARMADI



BACINELLE

PIANI
ALZATINELAVELLI
RUBINETTILAVORAZIONI
ACCESSORIOPEN BOX
SEGGIOLINI

PROF

MAESTRO

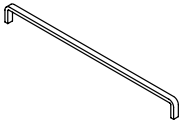
IMPIANTISTICA

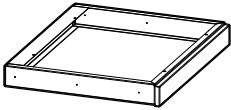
	Descrizione / Description Description / Beschreibung / Descripción	M³ Kg	Articolo Item / Article Artikel / Artículo	Prezzo Price / Prix Preis / Precio
	<p>MANIGLIA in alluminio per "Like"/"Steril K"</p> <p>Aluminium handle for "Like"/"Steril K"</p> <p>Poignée en aluminium pour "Like"/"Steril K"</p> <p>Griff aus Aluminium für "Like"/"Steril K"</p> <p>Tirador de aluminio para "Like"/"Steril K"</p>	Interasse / Wheelbase Entraxe / Abstand Distancia entre ejes 352	- 0,4	MA032 € 24,00
	<p>Supporto in tubolare per piano</p> <p>Tube top bracket</p> <p>Support en tube pour plan</p> <p>Rundrohrbeine für Arbeitsplatte</p> <p>Soporte en tubular para la encimera</p>		- 8	PSTP € 95,00
	<p>Cornice di finitura H 65 mm per vano L 600 mm completa di frontale</p> <p>Finishing frame h 65 mm for compartment l 600 mm with front</p> <p>Cadre de finition h 65 mm pour compartiment l 600 mm avec façade</p> <p>Zierrahmen H 65 mm für Fach L 600 mm mit Front</p> <p>Marco de acabado h 65 mm para compartimento l 600 mm con frente</p>		- 3	PCRA € 94,00

H 918 mm - Ø 60

L 600 x P 500 x H 65 mm

VELA

LOOK

LIKE

ALA / QUADRO
NOVO / UPRIGHT

MOVINGTRAY
MOVING ARM

PURFA
PURASTUDIO

STERIL K

CART

ARMADI

BACINELLE

PIANI
ALZATINE

LAVELLI
RUBINETTI

LAVORAZIONI
ACCESSORI

OPEN BOX
SEGGIOLINI

PROF

MAESTRO

IMPIANTISTICA

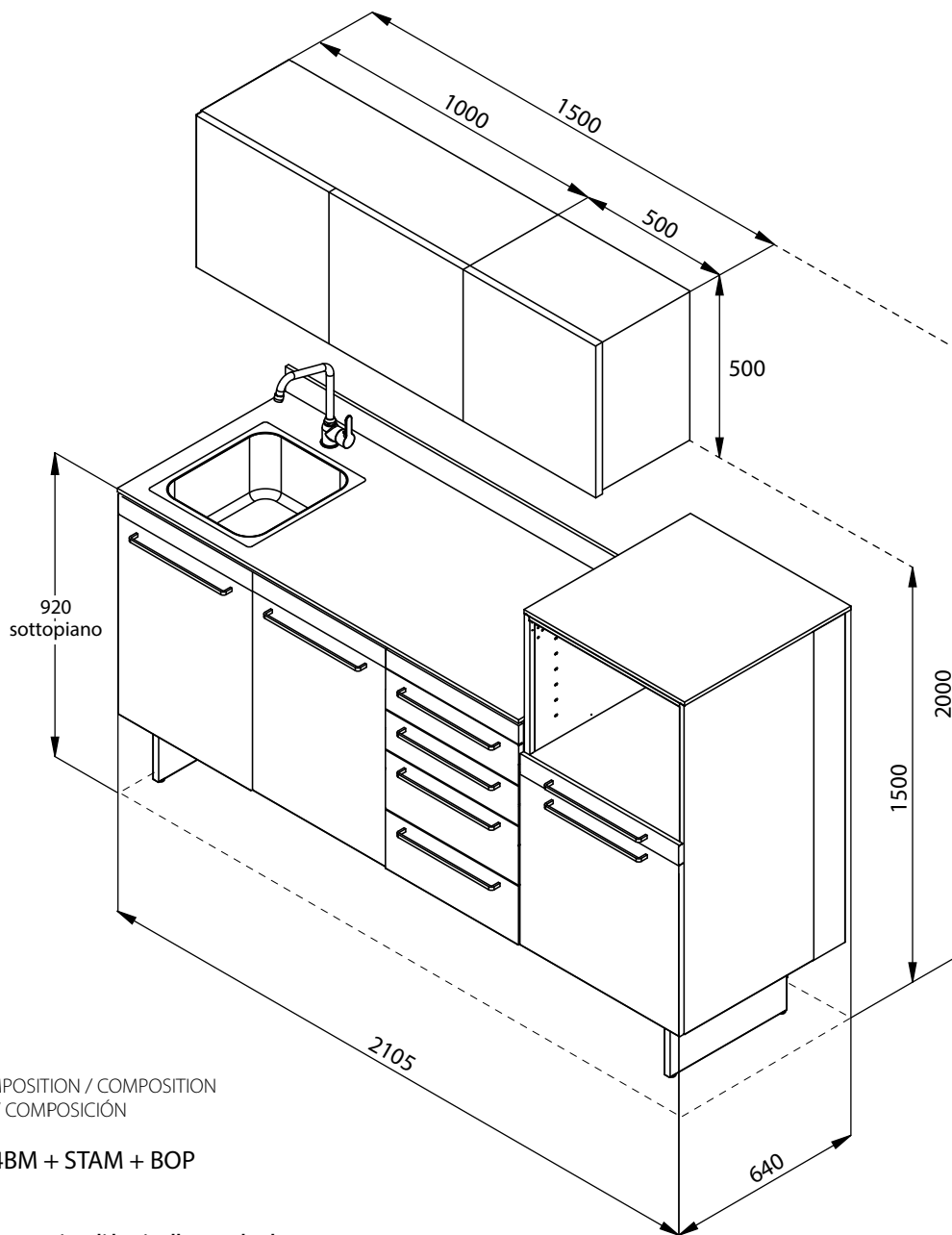

A

COMPOSIZIONE / COMPOSITION / COMPOSITION
ZUSAMMENSTELLUNG / COMPOSICIÓN

SLAM + SPAM + S4BM + STAM + BOP
SV0C + SV0F

La composizione è comprensiva di bacinelle standard.

Rubinetto e alzatina esclusi.

Trays included. Mixer excluded. Splashback excluded.

Intérieurs de tiroirs inclus. Robinet pas compris.

Dosseret pas compris.

Standard Schubladeneinsätze sind enthalten. Armatur ist

ausgeschlossen. Aufkantung ist ausgeschlossen.

La composición incluye bandejas estándar.

Grifo excluido. Alzada excluida.

		Con piedi / On feet Sur pieds / Mit Füßen / Con patas	Basamento / Base units / Bases / Sockel / Bases
		Maniglia Handle / Poignée Griff / Tirador	Maniglia Handle / Poignée Griff / Tirador
1	Piano in laminato Laminate worktop / Plan de travail en laminé / Arbeitsplatte aus Laminat / Encimera de laminado	+V15K (circolare) € 4.647,00	€ 4.594,00
2	Piano in stratificato Stratified top / Plan stratifié / Arbeitsplatte aus Schichtstoff / Encimera de estratificado	+V15 (circolare) € 5.426,00	€ 5.373,00

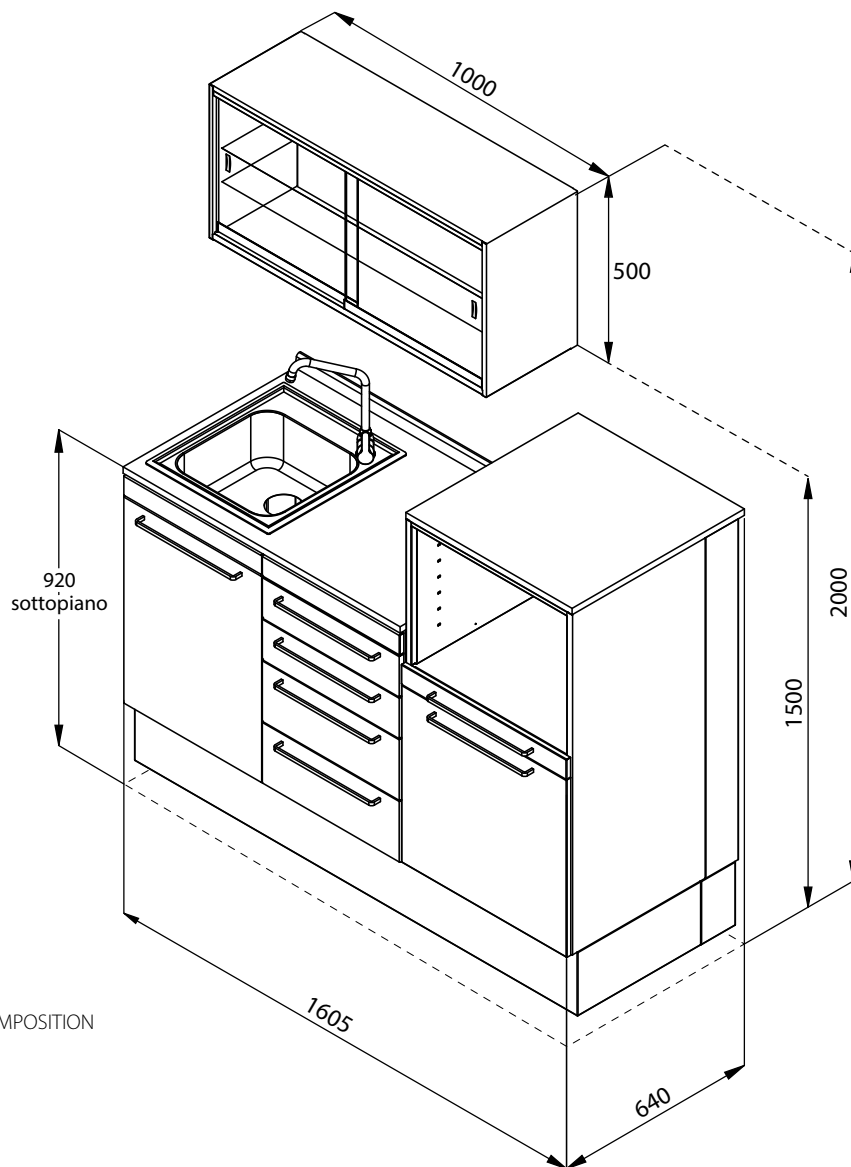

B

COMPOSIZIONE / COMPOSITION / COMPOSITION
ZUSAMMENSTELLUNG / COMPOSICIÓN

SLAM + S4BM + STAM + BOP
SV0H

La composizione è comprensiva di bacinelle standard.

Rubinetto e alzatina esclusi.

Trays included. Mixer excluded. Splashback excluded.

Intérieurs de tiroirs inclus. Robinet pas compris.

Dosseret pas compris.

Standard Schubladeneinsätze sind enthalten. Armatur ist

ausgeschlossen. Aufkantung ist ausgeschlossen.

La composición incluye bandejas estándar.

Grifo excluido. Alzada excluida.

		Con piedi / On feet Sur pieds / Mit Füßen / Con patas	Basamento / Base units / Bases / Sockel / Bases
		Maniglia Handle / Poignée Griff / Tirador	Maniglia Handle / Poignée Griff / Tirador
1	Piano in laminato Laminate worktop / Plan de travail en laminé / Arbeitsplatte aus Laminat / Encimera de laminado	+V15K (circolare) € 3.526,00	€ 3.516,00
2	Piano in stratificato Stratified top / Plan stratifié / Arbeitsplatte aus Schichtstoff / Encimera de estratificado	+V15 (circolare) € 4.134,00	€ 4.124,00

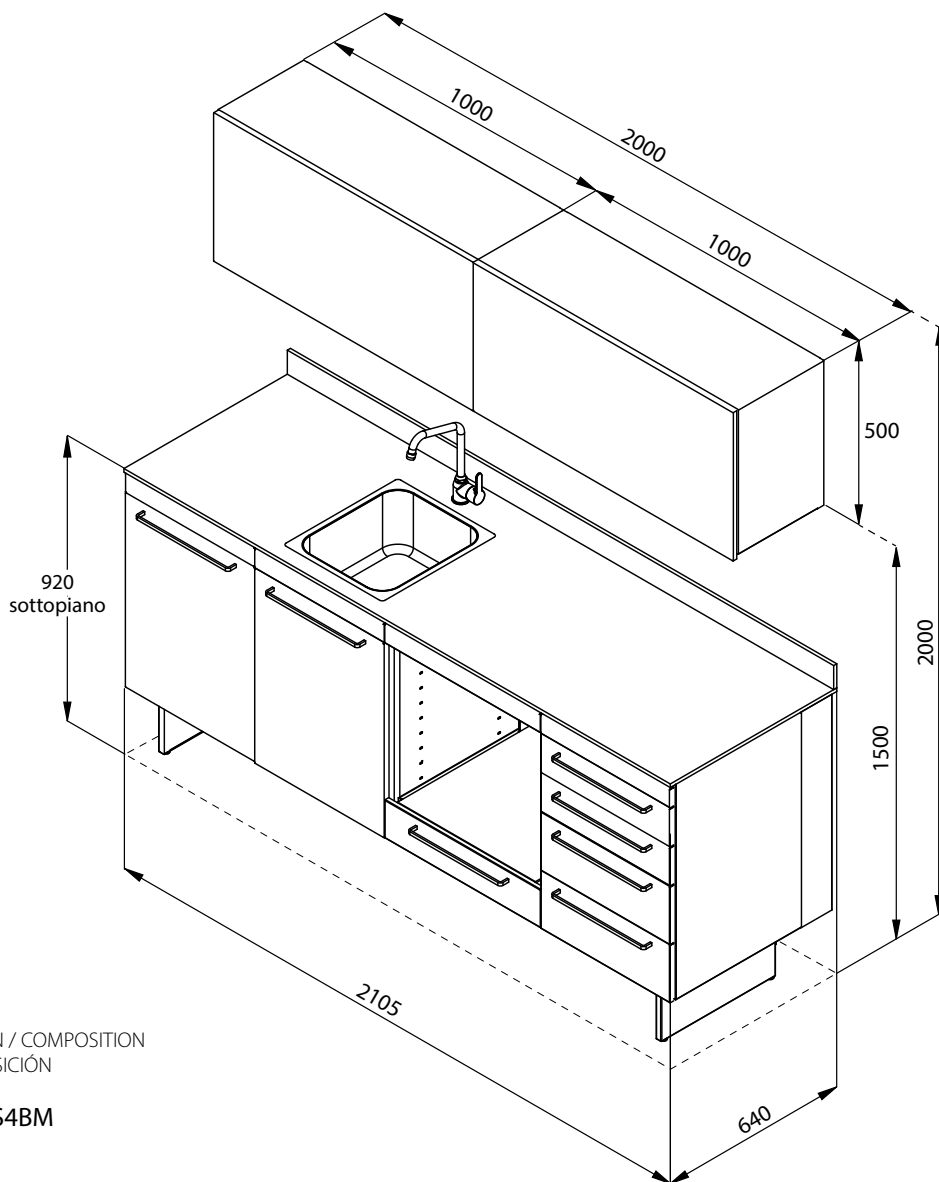

COMPOSIZIONE / COMPOSITION / COMPOSITION
ZUSAMMENSTELLUNG / COMPOSICIÓN

SPAM + SLAM + SAAM + S4BM
SV0A x2

La composizione è comprensiva di bacinelle standard.

Rubinetto e alzatina esclusi.

Trays included. Mixer excluded. Splashback excluded.

Intérieurs de tiroirs inclus. Robinet pas compris.

Dosseret pas compris.

Standard Schubladeneinsätze sind enthalten. Armatur ist

ausgeschlossen. Aufkantung ist ausgeschlossen.

La composición incluye bandejas estándar.

Grifo excluido. Alzada excluida.

		Con piedi / On feet Sur pieds / Mit Füßen / Con patas	Basamento / Base units / Bases / Sockel / Bases
		Maniglia Handle / Poignée Griff / Tirador	Maniglia Handle / Poignée Griff / Tirador
1	Piano in laminato Laminate worktop / Plan de travail en laminé / Arbeitsplatte aus Laminat / Encimera de laminado	+V15K (circolare) € 4.712,00	€ 4.659,00
2	Piano in stratificato Stratified top / Plan stratifié / Arbeitsplatte aus Schichtstoff / Encimera de estratificado	+V15 (circolare) € 5.486,00	€ 5.433,00

MATE | Carrello porta computer

LORAN

Computer trolley | Chariot pour ordinateur | Computerwagen | Mesa de ordenador con ruedas

	Descrizione / Description Description / Beschreibung / Descripción	M ³ Kg	Articolo Item / Article Artikel / Artículo	Prezzo Price / Prix Preis / Precio
	<p>Carrello porta computer con supporto per fissaggio del monitor e passacavi, vano porta PC, ripiano estraibile per tastiera, piano poggiapiedi, 2 ruote con freno, 2 prese.</p> <p>Computer trolley with Bracket for securing the monitor and cable glands, PC-holder compartment, Pull-out keyboard shelf, Footrest top, 2 Wheels with brake, 2 power sockets.</p> <p>Chariot pour ordinateur avec Étrier pour la fixation de l'écran et passe-câbles, Logement pour unité centrale, Tablette extractible pour clavier, Plan repose-pied, 2 Roulettes avec frein, 2 prises.</p> <p>Computerwagen mit Halterung mit Kabeln und Kabelkanälen, PC-Fach , Ausziehbare Tastaturablage, Fußablage, 2 Räder mit Bremse, 2 Steckdosenleisten.</p> <p>Carro informático con Soporte de fijación de la pantalla y pasacables, Compartimiento de la PC, Bandeja abatible para el teclado, Reposapiés, 2 Ruedas con freno, 2 tomas.</p>	-	MATE_01	€ 862,00
L 540 x P 473 x H 1167 mm		41		

	<p>PER PC PORTATILE: senza supporto monitor Carrello porta computer con passacavi, vano porta PC, 1 cassetto, piano poggiapiedi, 2 ruote con freno, 2 prese.</p> <p>FOR PORTABLE PC: with no bracket</p> <p>Computer trolley with cable glands, PC-holder compartment, 1 drawer, 2 Wheels with brake, 2 power sockets.</p> <p>POUR PC PORTABLE: sans étrier</p> <p>Chariot pour ordinateur avec passe-câbles, Logement pour unité centrale, 1 tiroir, Plan repose-pied, 2 Roulettes avec frein, 2 prises.</p> <p>FÜR LAPTOP: ohne Halterung</p> <p>Computerwagen mit Kabelkanälen, PC-Fach, 1 Schublade, Fußablage, 2 Räder mit Bremse, 2 Steckdosenleisten.</p> <p>PARA ORDENADOR PORTÁTIL: sin soporte</p> <p>Carro informático con pasacables, Compartimiento de la PC, 1 cajón, Reposapiés, 2 Ruedas con freno, 2 tomas.</p>	-	MATE_02	€ 780,00
L 540 x P 473 x H 831 mm		39		

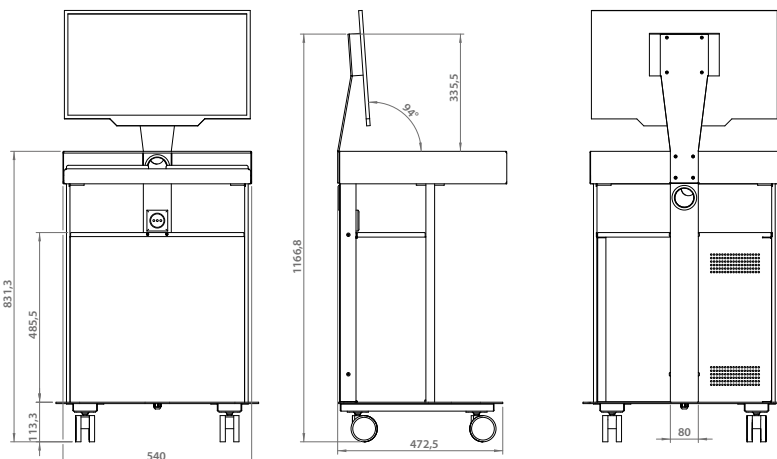

	Descrizione / Description Description / Beschreibung / Descripción	M ³ Kg	Articolo Item / Article Artikel / Artículo	Prezzo Price / Prix Preis / Precio
	<p>Carrello con 2 ripiani in metallo, elettrificato con 2 prese di corrente e cavo spiralato</p> <p>Cart with 2 metal shelves, 2 sockets and electrical spiral cable Cart avec 2 étagères métalliques, 2 prises électriques et cable spirale Gerätewagen mit 2 Metallböden, 2 Steckdosen und Spiralkabel Carro electrificado, equipado con estantes en metal, dos tomas de corriente, agujero pasacables y cable eléctrico extensible</p>	- ---	LOGO	€ 600,00
	<p>Carrello con 2 ripiani in metallo, con cassetto sotto al ripiano superiore, elettrificato con 2 prese di corrente e cavo spiralato</p> <p>Cart with an upper shelf with drawer, a single metal shelf, 2 sockets and electrical spiral cable Cart avec étagère supérieure avec tiroir, une étagère simple, 2 prises électriques et cable spirale Gerätewagen mit 2 Metallböden, Schublade unter dem oberen Boden, 2 Steckdosen und Spiralkabel Carro electrificado, equipado con estantes en metal, con un cajon, dos tomas de corriente, agujero pasacables y cable eléctrico extensible</p>	- ---	LOGOC	€ 738,00
	<p>Carrello con 2 ripiani in vetro, elettrificato con 2 prese di corrente e cavo spiralato</p> <p>Cart with 2 glass shelves, 2 sockets and electrical spiral cable Cart avec deux étagères en verre, 2 prises électriques et cable spirale Gerätewagen mit 2 Glasböden, 2 Steckdosen und Spiralkabel Carro electrificado, equipado con estantes en vidrio, dos tomas de corriente, agujero pasacables y cable eléctrico extensible</p>	- ---	LOGOV	€ 782,00
	<p>Carrello con 2 ripiani in vetro, con cassetto sotto al ripiano superiore, elettrificato con 2 prese di corrente e cavo spiralato</p> <p>Cart with an upper glass shelf with drawer, a single glass shelf, 2 sockets and electrical spiral cable Cart avec étagère supérieure en verre avec tiroir, étagère simple en verre, 2 prises électriques et cable spirale Gerätewagen mit 2 Glasböden, Schublade unter dem oberen Boden, 2 Steckdosen und Spiralkabel Carro electrificado, equipado con un cajon, estantes en vidrio, dos tomas de corriente, agujero pasacables y cable eléctrico extensible</p>	- ---	LOGOCV	€ 952,00

L 468 x P 400 x H 922 mm

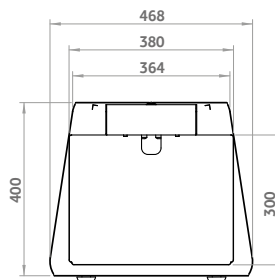
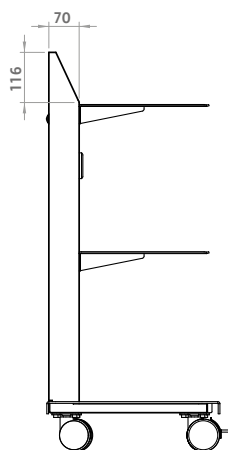
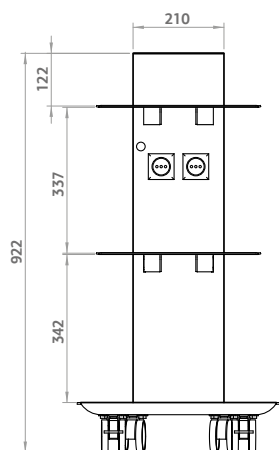

	Descrizione / Description Description / Beschreibung / Descripción	M³ Kg	Articolo Item / Article Artikel / Artículo	Prezzo Price / Prix Preis / Precio
	<p>CARRELLO PORTA APPARECCHI con 2 prese singole</p> <p>EQUIPMENT-CARRYING TROLLEY with 2 power sockets CARIOT POUR APPAREILS avec 2 prises Gerätetragewagen (Trolley für Geräte) mit 2 Steckdosenleisten CARRO PORTA EQUIPOS con 2 tomas</p>	0,22 23	LUNA	€ 848,00
L 430 x P 500 x H 845 mm				
	<p>CARRELLO PORTA APPARECCHI con 2 prese singole e PANNELLI COLORATI*</p> <p>EQUIPMENT-CARRYING TROLLEY with 2 power sockets AND COLOURED PANELS* CHARIOT POUR APPAREILS avec 2 prises ET PANNEAUX EN COULEUR* Gerätetragewagen (Trolley für Geräte) mit 2 Steckdosenleisten und farbige Paneele* CARRO PORTA EQUIPOS con 2 tomas y PANELES DE COLORES*</p> <p>* Tinte RAL / RAL colors / couleurs RAL / RAL Farbe / colores RAL</p>	0,22 23	LUNAV	€ 958,00
L 430 x P 500 x H 845 mm				
	<p>CARRELLO PORTA APPARECCHI con cassetto e 2 prese singole</p> <p>EQUIPMENT-CARRYING TROLLEY with drawer and 2 power sockets CHARIOT POUR APPAREILS avec tiroir et 2 prises Gerätetragewagen (Trolley für Geräte) mit Schublade und 2 Steckdosenleisten CARRO PORTA EQUIPOS con cajones y 2 tomas</p>	0,22 2,6	LUNAC	€ 958,00
L 430 x P 500 x H 845 mm				
	<p>CARRELLO PORTA APPARECCHI con cassetto e 2 prese singole e PANNELLI COLORATI*</p> <p>EQUIPMENT-CARRYING TROLLEY with drawer, 2 power sockets AND COLOURED PANELS* CHARIOT POUR APPAREILS avec tiroir, avec 2 prises ET PANNEAUX EN COULEUR* Gerätetragewagen (Trolley für Geräte) mit Schublade, 2 Steckdosenleisten und farbige Paneele* CARRO PORTA EQUIPOS con cajón, 2 tomas y PANELES DE COLORES*</p> <p>* Tinte RAL / RAL colors / couleurs RAL / RAL Farbe / colores RAL</p>	0,22 26	LUNACV	€ 1.069,00
L 430 x P 500 x H 845 mm				

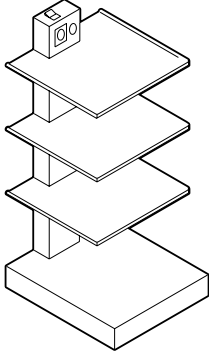
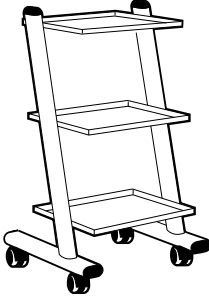
	Descrizione / Description Description / Beschreibung / Descripción	M³ Kg	Articolo Item / Article Artikel / Artículo	Prezzo Price / Prix Preis / Precio
 <p data-bbox="130 831 360 853">L 370 x P 430 x H 890 mm</p>	<p data-bbox="411 499 884 551">Carrello porta apparecchi con 3 prese Schuko sulla colonna</p> <p data-bbox="411 568 951 725"> Trolley for apparatus with 3 Schuko sockets Chariot porte-appareils avec 3 prises de courant Schuko Wagen für Geräte mit 3 Schuko-Steckdosen Carro portaaparatos con 3 tomas Schuko </p>	<p data-bbox="1054 790 1098 853">0,16 17</p>	<p data-bbox="1134 824 1257 853">SERVITOR</p>	<p data-bbox="1289 824 1445 853">€ 541,00</p>
 <p data-bbox="130 1350 360 1373">L 465 x P 395 x H 785 mm</p>	<p data-bbox="411 981 876 1032">Carrello porta apparecchi con presa multipla universale sul fondo</p> <p data-bbox="411 1059 932 1350"> Trolley for apparatus with multiple-outlet trailing socket at the base Chariot porte-appareils avec prise multiple universelle sur la base Wagen für Geräte mit einer Mehrfachsteckdose and der Unterfläche Carro portaaparatos con toma múltiple universal en la base </p>	<p data-bbox="1054 1305 1098 1368">0,16 12</p>	<p data-bbox="1158 1346 1230 1375">JOLIE</p>	<p data-bbox="1289 1346 1445 1375">€ 219,00</p>

VELA
LOOK
LIKE
ALA / QUADRO NOVO / UPRIGHT
MOVINGTRAY MOVING ARM
PURRA PURASTUDIO
STERIL K
CART
ARMADI
BACINELLE
PIANI ALZATINE
LAVELLI RUBINETTI
LAVORAZIONI ACCESSORI
OPEN BOX SEGGIOLINI
PROF
MAESTRO
IMPIANTISTICA

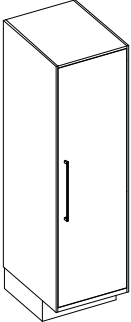
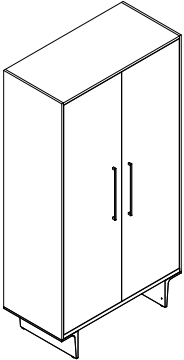
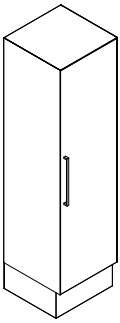
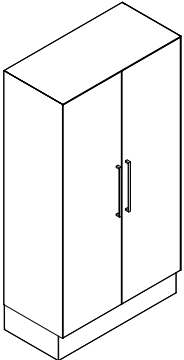
	Descrizione / Description Description / Beschreibung / Descripción	M ³ Kg	Articolo Item / Article Artikel / Artículo	Prezzo Price / Prix Preis / Precio
	<p>VELA Armadio con basamento, fianchi , coperchio, anta in metallo e 5 ripiani interni</p> <p>Cabinet with base, lateral sides, upper cover, door and 5 interior shelves</p> <p>Armoire avec base, panneaux latéraux, capot supérieur, porte et 5 étagères internes</p> <p>Schrank mit Sockel, Seitenwände, Deckel, Tür und 5 Einlegeböden</p> <p>Armario con base, paneles lateral, tapa superior, puerta y 5 estantes interiores</p>	0,70 74	ARV05B	€ 2.260,00
L 530 x P 500 x H 2040 mm				
	<p>VELA Armadio con basamento o supporto a pavimento, fianchi, coperchio, 2 ante in metallo e 5 ripiani interni</p> <p>Cabinet with base or floor support, lateral sides, upper cover, 2 doors and 5 interior shelves</p> <p>Armoire avec base ou support au sol, panneaux latéraux, capot supérieur, 2 portes et 5 étagères internes</p> <p>Schrank mit Sockel oder Bodengestell, Seitenwände, Deckel, 2 Türen und 5 Einlegeböden</p> <p>Armario con base o soporte de pie, paneles lateral, tapa superior, 2 puertas y 5 estantes interiores</p>	1,25 100	ARV10S <i>Supporto a pavimento Floor support Support au sol Bodengestell Soporte de pie</i>	€ 3.082,00
L 1030 P 500 x H 2040 mm			ARV10B <i>Basamento Base unit Base Sockel Base</i>	€ 2.752,00
	<p>PURA LOOK ARMADIO con basamento o supporto a pavimento, fianchi, copertura, anta in metallo e 5 ripiani interni</p> <p>Cabinet with base or support with feet, with door and 5 interior shelves</p> <p>Armoire avec base ou support avec pieds, avec porte et 5 étagères internes</p> <p>Schrank mit Sockel oder Gestell mit Füßen, mit Tür und 5 Einlegeböden</p> <p>Armario con base o soporte con patas, con puerta y 5 estantes interiores</p>	0,51 85	AR05PS <i>Supporto a pavimento Floor support Support au sol Bodengestell Soporte de pie</i>	€ 2.421,00
L 510 x P 500 x H 2000 mm			AR05PB <i>Basamento Base unit Base Sockel Base</i>	€ 2.184,00
	<p>PURA LOOK ARMADIO con basamento o supporto a pavimento, fianchi, copertura, 2 ante in metallo e 5 ripiani interni</p> <p>Cabinet with base or support with feet, with 2 doors and 5 interior shelves</p> <p>Armoire avec base ou support avec pieds, avec 2 portes et 5 étagères internes</p> <p>Schrank mit Sockel oder Gestell mit Füßen, mit 2 Türen und 5 Einlegeböden</p> <p>Armario con base o soporte con patas, con 2 puertas y 5 estantes interiores</p>	1,01 105	AR10PS <i>Supporto a pavimento Floor support Support au sol Bodengestell Soporte de pie</i>	€ 2.893,00
L 1010 x P 500 x H 2000 mm			AR10PB <i>Basamento Base unit Base Sockel Base</i>	€ 2.656,00

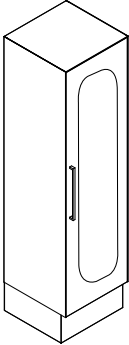
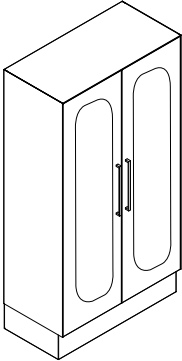
	Descrizione / Description Description / Beschreibung / Descripción	M³ Kg	Articolo Item / Article Artikel / Artículo	Prezzo Price / Prix Preis / Precio
 <p>PURA LOOK ARMADIO con basamento o supporto a pavimento, fianchi, copertura, 1 anta in vetro e 5 ripiani interni</p> <p>CABINET with base or support with feet, with 1 glass door and 5 interior shelves</p> <p>Armoire avec base ou support avec pieds, avec 1 porte en verre et 5 étagères internes</p> <p>SCHRANK mit Sockel oder Gestell mit Füßen, Seitenwände, Abdeckung, 1 Tür und 5 Einlegeböden</p> <p>Armario con base o soporte con patas, con 1 puerta de cristal y 5 estantes interiores</p> <p>L 510 x P 500 x H 2000 mm</p>		0,51	AV05PS Supporto a pavimento Floor support Support au sol Bodengestell Soporte de pie	€ 2.533,00
		92	AV05PB Basamento Base unit Base Sockel Base	€ 2.297,00
 <p>PURA LOOK ARMADIO con basamento o supporto a pavimento, fianchi, copertura, 2 ante in vetro e 5 ripiani interni</p> <p>Cabinet with base or support with feet, with 2 glass doors and 5 interior shelves</p> <p>Armoire avec base ou support avec pieds, avec 2 portes en verre et 5 étagères internes</p> <p>Schrank mit Sockel oder Gestell mit Füßen, mit 2 Türen aus Glas und 5 Einlegeböden</p> <p>Armario con base o soporte con patas, con 2 puertas de cristal y 5 estantes interiores</p> <p>L 1010 x P 500 x H 2000 mm</p>		1,01	AV10PS Supporto a pavimento Floor support Support au sol Bodengestell Soporte de pie	€ 3.118,00
		119	AV10PB Basamento Base unit Base Sockel Base	€ 2.881,00

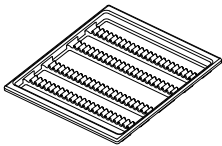
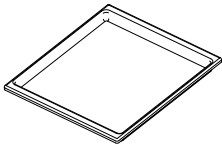
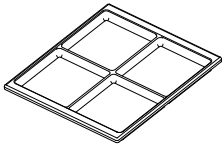
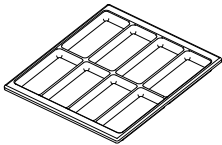
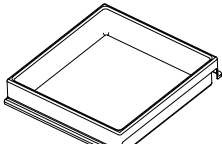
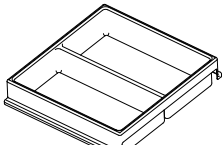
	Descrizione / Description Description / Beschreibung / Descripción	M ³ Kg	Articolo Item / Article Artikel / Artículo	Prezzo Price / Prix Preis / Precio
	BACINELLA con rastrelliera portastrumenti, per cassetto A Instrument compartment drawer tray, for drawer A Intérieur de tiroir porte-instruments, pour tiroir A Einsatz mit Instrumentenhalter, für Schublade A Bandeja porta instrumentos, para cajón A	- 0,5	VBA1	€ 22,00
L 440 x P 389 x H 31 mm				
	BACINELLA piana, per cassetto A Flat drawer tray, for drawer A Intérieur de tiroir bas, pour tiroir A Niedriger Einsatz, für Schublade A Bandeja plana, para cajón A	- 0,5	VBA2	€ 22,00
L 440 x P 389 x H 31 mm				
	BACINELLA a 4 settori, per cassetto A Drawer tray with 4 compartments, for drawer A Intérieur de tiroir à 4 secteurs, pour tiroir A 4-Fächern Einsatz, für Schublade A Bandeja con 4 sectores, para cajón A	- 0,5	VBA3	€ 22,00
L 440 x P 389 x H 31 mm				
	BACINELLA a 8 settori, per cassetto A Drawer tray with 8 compartments, for drawer A Intérieur de tiroir à 8 secteurs, pour tiroir A 8-Fächern Einsatz, für Schublade A Bandeja con 8 sectores, para cajón A	- 0,5	VBA4	€ 22,00
L 440 x P 389 x H 31 mm				
	BACINELLA piana, per cassetto B Flat drawer tray, for drawer B Intérieur de tiroir bas, pour tiroir B Niedriger Einsatz, für Schublade B Bandeja plana, para cajón B	- 0,9	VBB1	€ 28,00
L 400 x P 389 x H 90 mm				
	BACINELLA a 2 settori, per cassetto B Drawer tray with 2 compartment, for drawer B Intérieur de tiroir à 2 secteurs, pour tiroir B 2-Fächern Einsatz, für Schublade B Bandeja con 2 sectores, para cajón B	- 0,9	VBB2	€ 28,00
L 400 x P 389 x H 90 mm				

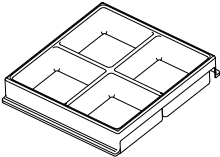
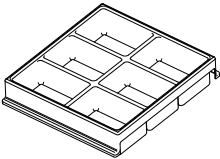
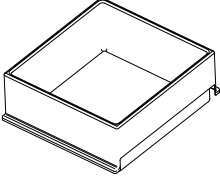
	Descrizione / Description Description / Beschreibung / Descripción	M³ Kg	Articolo Item / Article Artikel / Artículo	Prezzo Price / Prix Preis / Precio
 <p>BACINELLA a 4 settori, per cassetto B Drawer tray with 4 compartments, for drawer B Intérieur de tiroir à 4 secteurs, pour tiroir B 4-Fächern Einsatz, für Schublade B Bandeja con 4 sectores, para cajón B</p> <p>L 400 x P 389 x H 90 mm</p>	-	0,9	VBB3	€ 28,00
 <p>BACINELLA a 6 settori, per cassetto B Drawer tray with 6 compartments, for drawer B Intérieur de tiroir à 6 secteurs, pour tiroir B 6-Fächern Einsatz, für Schublade B Bandeja con 6 sectores, para cajón B</p> <p>L 400 x P 389 x H 90 mm</p>	-	0,9	VBB4	€ 28,00
 <p>BACINELLA piana, per cassetti C e D Flat drawer tray, for drawers C and D Intérieur de tiroir bas, pour tiroirs C et D Niedriger Einsatz, für Schubladen C und D Bandeja plana, para cajones C y D</p> <p>L 400 x P 389 x H 165 mm</p>	-	1,1	VBC1	€ 54,00

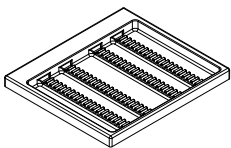
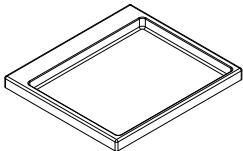
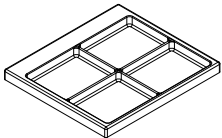
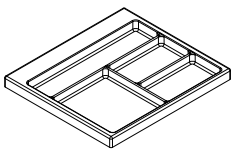
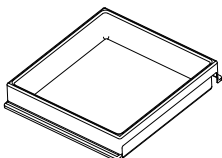
	Descrizione / Description Description / Beschreibung / Descripción	M ³ Kg	Articolo Item / Article Artikel / Artículo	Prezzo Price / Prix Preis / Precio
	BACINELLA con rastrelliera portastrumenti, per cassetto A Instrument compartment drawer tray, for drawer A Intérieur de tiroir porte-instruments, pour tiroir A Einsatz mit Instrumentenhalter, für Schublade A Bandeja porta instrumentos, para cajón A	- 0,5	LBA1	€ 22,00
L 425 x P 379 x H 31 mm				
	BACINELLA piana, per cassetto A Flat drawer tray, for drawer A Intérieur de tiroir bas, pour tiroir A Niedriger Einsatz, für Schublade A Bandeja plana, para cajón A	- 0,5	LBA2	€ 22,00
L 425 x P 379 x H 31 mm				
	BACINELLA a 4 settori, per cassetto A Drawer tray with 4 compartments, for drawer A Intérieur de tiroir à 4 secteurs, pour tiroir A 4-Fächern Einsatz, für Schublade A Bandeja con 4 sectores, para cajón A	- 0,5	LBA3	€ 22,00
L 425 x P 379 x H 31 mm				
	BACINELLA a 4 settori, per cassetto A Drawer tray with 4 compartments, for drawer A Intérieur de tiroir à 4 secteurs, pour tiroir A 4-Fächern Einsatz, für Schublade A Bandeja con 4 sectores, para cajón A	- 0,5	LBA4	€ 22,00
L 425 x P 379 x H 31 mm				
	BACINELLA piana, per cassetto B Flat drawer tray, for drawer B Intérieur de tiroir bas, pour tiroir B Niedriger Einsatz, für Schublade B Bandeja plana, para cajón B	- 0,9	LBB1	€ 28,00
L 400 x P 389 x H 90 mm				

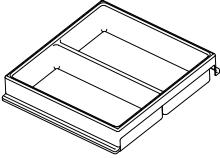
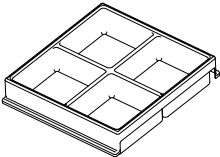
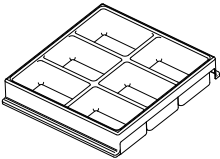
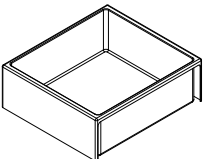
	Descrizione / Description Description / Beschreibung / Descripción	M³ Kg	Articolo Item / Article Artikel / Artículo	Prezzo Price / Prix Preis / Precio
	BACINELLA a 2 settori, per cassetto B Drawer tray with 2 compartment, for drawer B Intérieur de tiroir à 2 secteurs, pour tiroir B 2-Fächern Einsatz, für Schublade B Bandeja con 2 sectores, para cajón B	- 0,9	LBB2	€ 28,00
L 400 x P 389 x H 90 mm				
	BACINELLA a 4 settori, per cassetto B Drawer tray with 4 compartments, for drawer B Intérieur de tiroir à 4 secteurs, pour tiroir B 4-Fächern Einsatz, für Schublade B Bandeja con 4 sectores, para cajón B	- 0,9	LBB3	€ 28,00
L 400 x P 389 x H 90 mm				
	BACINELLA a 6 settori, per cassetto B Drawer tray with 6 compartments, for drawer B Intérieur de tiroir à 6 secteurs, pour tiroir B 6-Fächern Einsatz, für Schublade B Bandeja con 6 sectores, para cajón B	- 0,9	LBB4	€ 28,00
L 400 x P 389 x H 90 mm				
	BACINELLA piana, per cassetti C e D Flat drawer tray, for drawers C and D Intérieur de tiroir bas, pour tiroirs C et D Niedriger Einsatz, für Schubladen C und D Bandeja plana, para cajones C y D	- 1,1	LBC1	€ 54,00
L 423 x P 379 x H 145 mm				

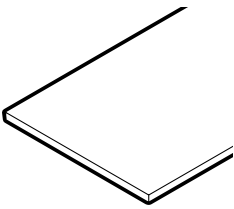
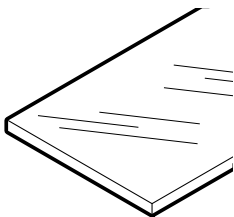
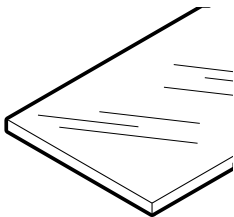
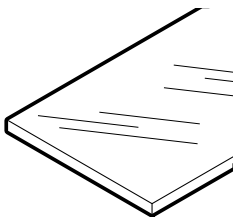
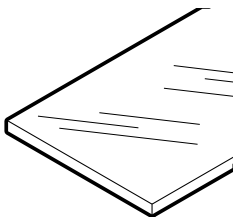
	Descrizione / Description Description / Beschreibung / Descripción	M³ Kg	Articolo Item / Article Artikel / Artículo	Prezzo Price / Prix Preis / Precio
 <p>Piano in Corian® bianco: al metro lineare White Corian® top: per meter Plan en Corian® blanc: au mètre Weiß Corian® Arbeitsplatte: je Meter Encimera de Corian® blanco: al m.</p> <p>P 455 x H 12 mm P 505 x H 12 mm P 600 x H 12 mm</p>		- 10	CA (P 455 mm)	€ 582,00
		- 11	CB (P 505 mm)	€ 582,00
		- 13	CD (P 600 mm)	€ 670,00
 <p>Piano in vetro: al metro lineare Glass top: per meter Plan en verre: au mètre Glasarbeitsplatte: je Meter Encimera de vidrio: al m.</p> <p>P 455 x H 15 mm P 505 x H 15 mm P 600 x H 15 mm</p>		- 17	VA (P 455 mm)	€ 481,00
		- 19	VB (P 505 mm)	€ 481,00
		- 19	VD (P 600 mm)	€ 625,00
 <p>Piano in vetro satinato: al metro lineare Glass top satin: per meter Plan en verre dépoli: au mètre Satinierter Glasarbeitsplatte: je Meter Encimera de vidrio satinado: al m.</p> <p>P 455 x H 15 mm P 505 x H 15 mm P 600 x H 15 mm</p>		- 17	XA (P 455 mm)	€ 594,00
		- 19	XB (P 505 mm)	€ 594,00
		- 19	XD (P 600 mm)	€ 773,00
 <p>Piano in vetro extra-chiaro: al metro lineare Extra clear glass top: per meter Plan en verre transparent: au mètre Transparente Glasarbeitsplatte: je Meter Encimera de vidrio transparente: al m.</p> <p>P 455 x H 15 mm P 505 x H 15 mm P 600 x H 15 mm</p>		- 17	YA (P 455 mm)	€ 577,00
		- 19	YB (P 505 mm)	€ 577,00
		- 19	YD (P 600 mm)	€ 749,00
 <p>Piano in vetro extra-chiaro satinato: al metro lineare Extra-clear glass top satin: per meter Plan en verre transparent dépoli: au mètre Transparente satinierter Glasarbeitsplatte: je Meter Encimera de vidrio transparente satinado: al m.</p> <p>P 455 x H 15 mm P 505 x H 15 mm P 600 x H 15 mm</p>		- 17	ZA (P 455 mm)	€ 691,00
		- 19	ZB (P 505 mm)	€ 691,00
		- 19	ZD (P 600 mm)	€ 898,00

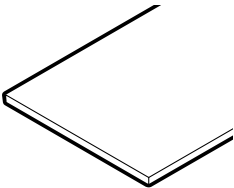
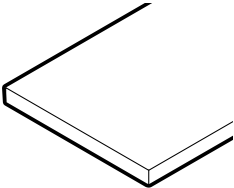
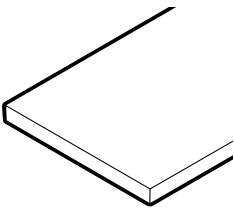
	Descrizione / Description Description / Beschreibung / Descripción	M³ Kg	Articolo Item / Article Artikel / Artículo	Prezzo Price / Prix Preis / Precio
 <p>Piano in stratificato bianco: al metro lineare White stratified top: per meter Plan en stratifié blanc: au mètre Weiß Schichtstoffarbeitsplatte: je Meter Encimera de estratificado blanco: al m.</p> <p>P 455 x H 12 mm P 505 x H 12 mm P 600 x H 12 mm</p>		- 8,6	SA (P 455 mm)	€ 449,00
		- 9,6	SB (P 505 mm)	€ 449,00
		- 11,4	SD (P 600 mm)	€ 530,00
 <p>Piano in laminato Fenix®: al metro lineare Fenix® - laminate worktop: per meter Plan de travail en laminé Fenix®: au mètre Arbeitsplatte aus Laminat Fenix®: je Meter Encimera de laminado Fenix®: al m.</p> <p>P 455 x H 20 mm P 505 x H 20 mm P 600 x H 20 mm</p>		- 6	FA (P 455 mm)	€ 205,00
		- 6,4	FB (P 505 mm)	€ 205,00
		- 7,6	FD (P 600 mm)	€ 245,00
 <p>Piano in laminato: al metro lineare Laminate worktop: per meter Plan de travail en laminé: au mètre Arbeitsplatte aus Laminat: je Meter Encimera de laminado: al m.</p> <p>NOTA: Alzatina consigliata ALB (Pag. 152) Suggested splashback ALB (Page 152) Dossieret conseillé ALB (Page 152) Geraten Wasserhahn ALB (Seite 152) Alzada recomendada ALB (Pág.152)</p> <p>P 455 x H 20 mm P 505 x H 20 mm P 600 x H 20 mm</p>		- 10	DA (P 455 mm)	€ 164,00
		- 11	DB (P 505 mm)	€ 164,00
		- 12	DD (P 600 mm)	€ 184,00

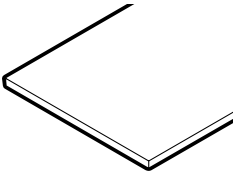
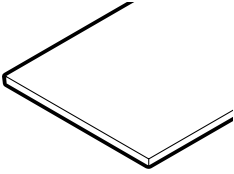
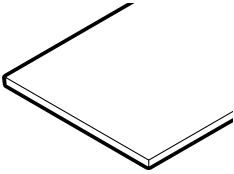
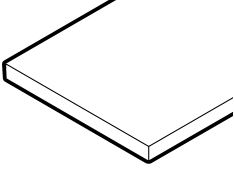
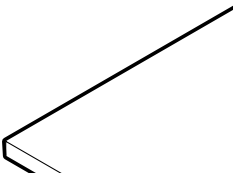
	Descrizione / Description Description / Beschreibung / Descripción	M³ Kg	Articolo Item / Article Artikel / Artículo	Prezzo Price / Prix Preis / Precio
 <p>Piano in Corian® bianco: al metro lineare White Corian® top: per meter Plan en Corian® blanc: au mètre Weiß Corian® Arbeitsplatte: je Meter Encimera de Corian® blanco: al m.</p>		- 13,9	CE (P. 640 mm)	€ 687,00
		- 15,2	CG (P. 700 mm)	€ 754,00
 <p>Piano in stratificato bianco: al metro lineare White stratified top: per meter Plan en stratifié blanc: au mètre Weiß Schichtstoffarbeitsplatte: je Meter Encimera de estratificado blanco: al m.</p>		- 12,2	SE (P. 640 mm)	€ 530,00
		- 13,3	SG (P. 700 mm)	€ 558,00
 <p>Piano in acciaio inox: al metro lineare Stainless steel top: per meter Plan en acier inox : au mètre Edelstahlarbeitsplatte: je Meter Encimera de acero inox: al m.</p>		- 13,9	AE (P. 640 mm)	€ 681,00
		- 15,2	AG (P. 700 mm)	€ 760,00
 <p>Piano in laminato Fenix®: al metro lineare Fenix® - laminate worktop: per meter Plan de travail en laminé Fenix®: au mètre Arbeitsplatte aus Laminat Fenix®: je Meter Encimera de laminado Fenix®: al m.</p>		- 8,1	FE (P. 640 mm)	€ 245,00
		- 8,9	FG (P. 700 mm)	€ 260,00
 <p>Piano in laminato: al metro lineare Laminate worktop: per meter Plan de travail en laminé: au mètre Arbeitsplatte aus Laminat: je Meter Encimera de laminado: al m.</p> <p>NOTA: Alzatina consigliata ALB (Pag. 152) Suggested splashback ALB (Page 152) Dossieret conseillé ALB (Page 152) Geraten Wasserhahn ALB (Seite 152) Alzada recomendada ALB (Pág.152)</p>		- 10	DE (P. 640 mm)	€ 191,00
		- 11	DG (P. 700 mm)	€ 199,00

P 640 x H 12 mm
P 700 x H 12 mm

P 640 x H 12 mm
P 700 x H 12 mm

P 640 x H 20 mm
P 700 x H 20 mm

P 640 x H 20 mm
P 700 x H 20 mm

P 640 x H 20 mm
P 700 x H 20 mm

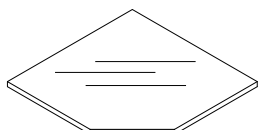
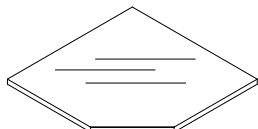
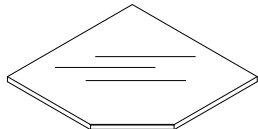
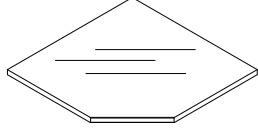
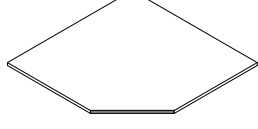
	Descrizione / Description Description / Beschreibung / Descripción	M³ Kg	Articolo Item / Article Artikel / Artículo	Prezzo Price / Prix Preis / Precio
	Piano angolare in Corian® bianco White Corian® top for corner units Plan en Corian® blanc pour modules d'angle Weiß Corian® Arbeitsplatte für Eckschränke Encimera de Corian® blanco para módulos angulares	- 11,6	CBV	€ 696,00
L 755 x P 755 x H 12 mm				
	Piano angolare in vetro Glass top for corner units Plan en verre pour modules d'angle Glasarbeitsplatte für Eckschränke Encimera de vidrio para módulos angulares	- 20,2	VBV	€ 599,00
L 755 x P 755 x H 15 mm				
	Piano angolare in vetro satinato Glass top satin for corner units Plan en verre dépoli pour modules d'angle Satinierter Glasarbeitsplatte für Eckschränke Encimera de vidrio satinado para módulos angulares	- 20,2	XBV	€ 728,00
L 755 x P 755 x H 15 mm				
	Piano angolare in vetro extra-chiaro Extra-clear glass top for corner units Plan en verre transparent pour modules d'angles Transparente Glasarbeitsplatte für Eckschränke Encimera de vidrio transparente para módulos angulares	- 20,2	YBV	€ 719,00
L 755 x P 755 x H 15 mm				
	Piano angolare in vetro extra-chiaro satinato Extra clear glass top satin for corner units Plan en verre transparent dépoli pour modules d'angles Transparente satinierte Glasarbeitsplatte für Eckschränke Encimera de vidrio trasparente satinado para módulos angulares	- 20,2	ZBV	€ 848,00
L 755 x P 755 x H 15 mm				
	Piano angolare in stratificato bianco White stratified top for corner units Plan en stratifié blanc pour modules d'angles Weiß Schichtstoffarbeitsplatte für Eckschränke Encimera de estratificado blanco para módulos angulares	- 10,2	SBV	€ 587,00
L 755 x P 755 x H 12 mm				

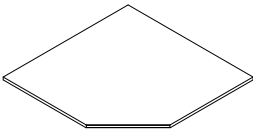
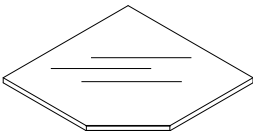
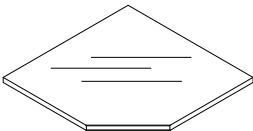
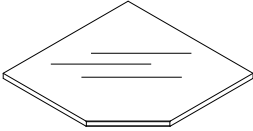
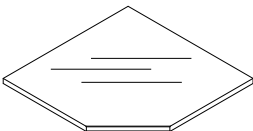
	Descrizione / Description Description / Beschreibung / Descripción	M³ Kg	Articolo Item / Article Artikel / Artículo	Prezzo Price / Prix Preis / Precio
	Piano angolare in Corian® bianco White Corian® top for corner units Plan en Corian® blanc pour modules d'angle Weiß Corian® Arbeitsplatte für Eckschränke Encimera de Corian® blanco para módulos angulares	- 10,3	CAV	€ 631,00
L 705 x P 705 x H 12 mm				
	Piano angolare in vetro Glass top for corner units Plan en verre pour modules d'angle Glasarbeitsplatte für Eckschränke Encimera de vidrio para módulos angulares	- 18	VAV	€ 599,00
L 705 x P 705 x H 15 mm				
	Piano angolare in vetro satinato Glass top satin for corner units Plan en verre dépoli pour modules d'angle Satinierter Glasarbeitsplatte für Eckschränke Encimera de vidrio satinado para módulos angulares	- 18	XAV	€ 728,00
L 705 x P 705 x H 15 mm				
	Piano angolare in vetro extra-chiaro Extra-clear glass top for corner units Plan en verre transparent pour modules d'angles Transparente Glasarbeitsplatte für Eckschränke Encimera de vidrio transparente para módulos angulares	- 18	YAV	€ 719,00
L 705 x P 705 x H 15 mm				
	Piano angolare in vetro extra-chiaro satinato Extra-clear glass top satin for corner units Plan en verre transparent dépoli pour modules d'angles Transparente satinierter Glasarbeitsplatte für Eckschränke Encimera de vidrio transparente satinado para módulos angulares	- 18	ZAV	€ 848,00
L 705 x P 705 x H 15 mm				

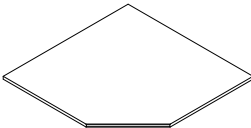
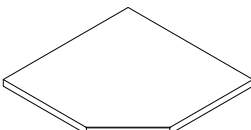
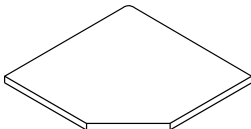
	Descrizione / Description Description / Beschreibung / Descripción	M³ Kg	Articolo Item / Article Artikel / Artículo	Prezzo Price / Prix Preis / Precio
 <p>Piano angolare in stratificato bianco White stratified top for corner units Plan en stratifié blanc pour modules d'angles Weiß Schichtstoffarbeitsplatte für Eckschränke Encimera de estratificado blanco para módulos angulares</p> <p>L 705 x P 705 x H 12 mm</p>		- 9	SAV	€ 533,00
	 <p>Piano angolare in laminato Fenix® White laminate top Fenix® for corner units Plan en laminé blanc Fenix® pour modules d'angles Weiße Laminatarbeitsplatte Fenix® für Eckschränke Encimera de laminado blanco Fenix® para módulos angulares</p> <p>L 705 x P 705 x H 20 mm L 755 x P 755 x H 20 mm L 850 x P 850 x H 20 mm</p>		- 6	FAV (P 705 mm)
		- 7	FBV (P 755 mm)	€ 391,00
		- 9	FDV (P 850 mm)	€ 442,00
 <p>Piano angolare in laminato White laminate top for corner units Plan en laminé blanc pour modules d'angles Weiße Laminatarbeitsplatte für Eckschränke Encimera de laminado blanco para módulos angulares</p> <p>L 705 x P 705 x H 20 mm L 755 x P 755 x H 20 mm L 800 x P 800 x H 20 mm</p>			- 11	DAV
		- 13	DBV	€ 253,00
		- 15	DDV	€ 316,00

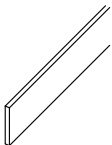
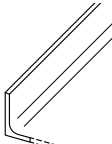
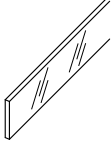
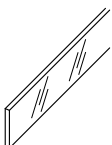
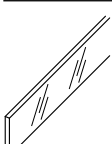
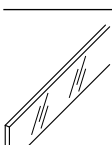
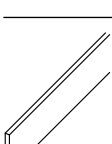
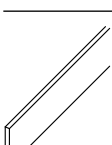
	Descrizione / Description Description / Beschreibung / Descripción	M ³ Kg	Articolo Item / Article Artikel / Artículo	Prezzo Price / Prix Preis / Precio
 <p>SP 12 x H 80 mm SP 12 x H 12 mm</p>	<p>Alzatina in Corian® bianco: al metro lineare White Corian® splashback: per meter Dosseret en Corian® blanc: au mètre Weiß Corian® Aufkantung: je Meter Alzada de Corian® blanco: al m.</p>	- 1,5	AC08 (H 80 mm)	€ 120,00
		- 0,3	AC01 (H 12 mm)	€ 100,00
 <p>SP 12 x H 30 mm</p>	<p>Alzatina in Corian® raccordata al piano Corian® upstand connected to the top Dosseret en Corian® relié au plan Aufsatz aus Corian®, mit der Auflagefläche verbunden Elevación de Corian® conectada a la encimera</p>	- 0,6	ACR0 (H 30 mm)	€ 352,00
 <p>SP 15 x H 80 mm SP 15 x H 100 mm</p>	<p>Alzatina in vetro: al metro lineare Glass splashback: per meter Dosseret en verre: au mètre Glasaufkantung: je Meter Alzada de vidrio: al m.</p>	- 3	AV08 (H 80 mm)	€ 90,00
 <p>SP 15 x H 80 mm SP 15 x H 100 mm</p>	<p>Alzatina in vetro satinato: al metro lineare Glass splashback satin: per meter Dosseret en verre dépoli: au mètre Satinierter Glasaufkantung: je Meter Alzada de vidrio satinado: al m.</p>	- 3	AX08 (H 80 mm)	€ 107,00
 <p>SP 15 x H 80 mm SP 15 x H 100 mm</p>	<p>Alzatina in vetro extra-chiaro: al metro lineare Extra-clear glass splashback: per meter Dosseret en verre transparent: au mètre Transparente Glasaufkantung: je Meter Alzada de vidrio transparente: al m.</p>	- 3	AY08 (H 80 mm)	€ 114,00
 <p>SP 15 x H 80 mm SP 15 x H 100 mm</p>	<p>Alzatina in vetro extra-chiaro satinato: al metro lineare Extra-clear glass splashback satin: per meter Dosseret en verre transparent dépoli: au mètre Transparente satinierter Glasaufkantung: je Meter Alzada de vidrio transparente satinado: al m.</p>	- 3	AZ08 (H 80 mm)	€ 132,00
 <p>SP 12 x H 80 mm</p>	<p>Alzatina in stratificato bianco: al metro lineare White stratified splashback: per meter Dosseret en stratifié blanc: au mètre Weiß Schichtstoffaufkantung: je Meter Alzada de estratificado blanco: al m.</p>	- 1,5	AS08 (H 80 mm)	€ 109,00
 <p>SP 20 x H 80 mm</p>	<p>Alzatina in laminato Fenix®: al metro lineare Splashback laminate Fenix®: per meter Dosseret en laminé Fenix®: au mètre Aufkantung aus laminat Fenix®: je Meter Alzada de laminato Fenix®: al m.</p>	- 1	AF08 (H 80 mm)	€ 76,00

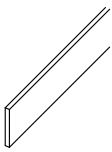
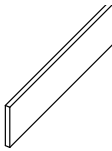
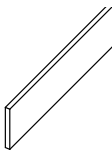
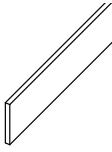
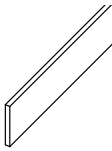
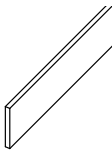
	Descrizione / Description Description / Beschreibung / Descripción	M ³ Kg	Articolo Item / Article Artikel / Artículo	Prezzo Price / Prix Preis / Precio
 SP 20 x H 80 mm	Alzatina in laminato: al metro lineare Laminate splashback: per meter Dosseret en laminé: au mètre Aufkantung aus laminat: je Meter Salpicadero laminado: por metro	- 1	AD08	€ 66,00
 SP 12 x H 100 mm	Alzatina in Corian® bianco: al metro lineare White Corian® splashback: per meter Dosseret en Corian® blanc: au mètre Weiß Corian® Aufkantung: je Meter Alzada de Corian® blanco: al m.	- 2,8	AC10	€ 152,00
 SP 12 x H 100 mm	Alzatina in stratificato bianco: al metro lineare White stratified splashback: per meter Dosseret en stratifié blanc: au mètre Weiß Schichtstoffaufkantung: je Meter Alzada de estratificado blanco: al m.	- 2,8	AS10	€ 127,00
 SP 20 x H 100 mm	Alzatina in acciaio Inox: al metro lineare Stainless steel splashback: per meter Dosseret en acier inox: au mètre Edelstahl Aufkantung: je Meter Alzada de acero inox: al m.	- 3,3	AA10	€ 176,00
 SP 20 x H 100 mm	Alzatina in laminato: al metro lineare Laminate splashback: per meter Dosseret en laminé: au mètre Aufkantung aus laminat: je Meter Salpicadero laminado: por metro	- 1,9	AD10	€ 76,00
 SP 20 x H 100 mm	Alzatina in laminato Fenix®: al metro lineare Splashback laminate Fenix®: per meter Dosseret en laminé Fenix®: au mètre Aufkantung aus laminat Fenix®: je Meter Alzada de laminato Fenix®: al m.	- 1,9	AF10	€ 86,00

Minimo fatturabile: 1 metro lineare

Minimum charge: 1 meter

Base minimale de facturation: 1 mètre

Mindestgebühr: 1meter

Mínimo facturable: 1 metro

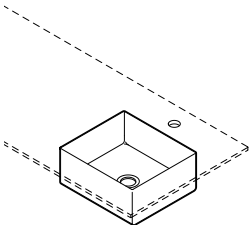
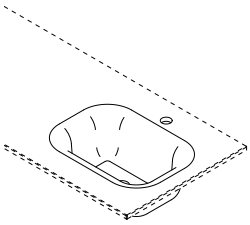
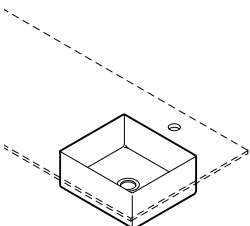
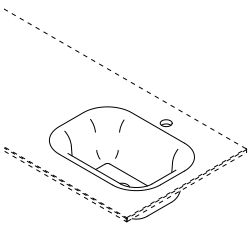
	Descrizione / Description Description / Beschreibung / Descripción	M³ Kg	Articolo Item / Article Artikel / Artículo	Prezzo Price / Prix Preis / Precio
 <p>Lavello integrato in Corian® Integrated Corian® sink Evier intégré en Corian® Integrierte Waschbecken aus Corian® Lavabo integrado de Corian®</p> <p>L 400 x P 260 x H 110 mm</p>			VIC	€ 1.067,00
 <p>Lavello termoformato in Corian® Integrated thermoformed Corian® sink Evier intégré thermoformé en Corian® Integriertes tiefgezogenes Waschbecken aus Corian® Lavabo integrado termoformato de Corian®</p> <p>L 400 x P 300 x H 130 mm</p>			VTC	€ 695,00
 <p>Lavello sottopiano in acciaio inox, per piani in Corian® e stratificato Undermont stainless steel sink, for Corian® and stratified top Evier en inox, pour plans en Corian® et stratifié Unterbauedelstahlwaschbecken, für Arbeitsplatte aus Corian® und Schichtstoff Lavabo bajo encimera de acero para encimeras de Corian® y estratificado</p> <p>L 400 x P 270 x H 195 mm</p>			VFA	€ 712,00
 <p>Lavello integrato in vetro Integrated glass sink Evier intégré en verre Integriertes, tiefgezogenes Glaswaschbecken Lavabo integrado de vidrio</p> <p>NB: piani lineari L 2800 mm max. / Straight tops L 2800 mm max. / Plans linéaires L 2800 mm max. / Gerade Arbeitsplatte L 2800 mm max. / Encimera lineal L 2800 mm max.</p> <p>L 400 x P 300 x H 130 mm</p>			VIV	€ 1.195,00

LAVELLI | Vela, Look

Sinks / Eiers / Waschbecken / Lavabos

LORAN

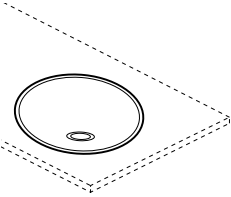
	Descrizione / Description Description / Beschreibung / Descripción	M³ Kg	Articolo Item / Article Artikel / Artículo	Prezzo Price / Prix Preis / Precio
	<p>Lavello a semisfera in acciaio inox sopra piano</p> <p>Top mounted stainless steel sink Evier en inox sur plan Aufgesetztes Edelstahlwaschbecken Lavabo de acero sobre encimera</p> <p>NB: si consiglia il rubinetto RB3 / mixer RB3 suggested / robinet RB3 conseillé / Wasserhahn RB3 empfohlen / se aconseja el grifo RB3</p>	- 1	VAS	€ 465,00
Ø 340 mm - H 160 mm				

LAVELLI | Vela, Look, Like, Sinks / Eiers / Waschbecken / Lavabos

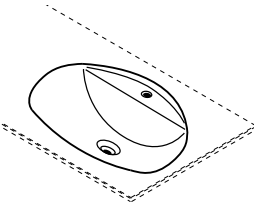
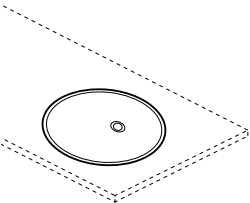
	<p>Lavello in ceramica a filo piano</p> <p>Flush ceramic bowl Evier porcelaine collée sous le plan Porzellanwaschbecken bündig mit der Arbeitsplatte Lavabo de cerámica a ras de la encimera</p>	- 7,2	VCF	€ 405,00
Laminato / Lamine / Laminé / Laminat / Laminado				
L 455 x P 405 mm				
	<p>Stratificato / Stratified / Stratifié / Schichtstoff / Estratificado</p>	- 7,2	VCS	€ 527,00
Stratificato / Stratified / Stratifié / Schichtstoff / Estratificado				
	<p>Lavello in acciaio smaltato</p> <p>Enamel steel sink Evier en acier inox émaillé Aufgesetztes emailiertes Stahl-Waschbecken Lavabo de acero esmaltado</p>	- 1	VSS	€ 331,00
Ø 340 mm - H 160 mm				

LAVELLI | Steril K Sinks / Eiers / Waschbecken / Lavabos

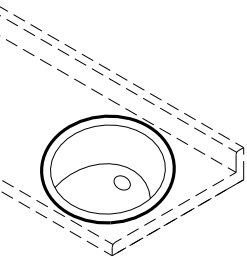
	<p>Lavello circolare in acciaio inox sopra piano</p> <p>Top mounted stainless steel sink Evier en inox sur plan Aufgesetztes Edelstahlwaschbecken Lavabo de acero sobre encimera</p> <p>Solo per Steril K con piano in laminato</p>	- 1	V1SK	€ 235,00
Ø 380 - H 180 mm				

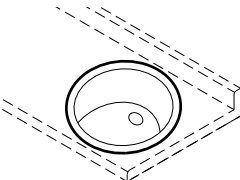
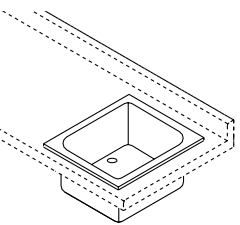
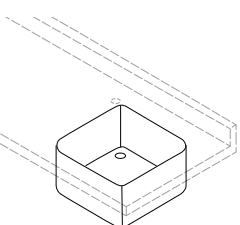
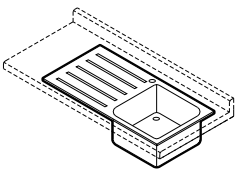
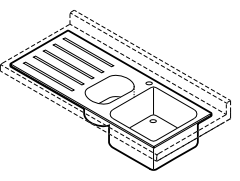
	Descrizione / Description Description / Beschreibung / Descripción	M ³ Kg	Articolo Item / Article Artikel / Artículo	Prezzo Price / Prix Preis / Precio
PURA (per piani prof. 505 - 520 - 600 mm)				
	<p>Lavello circolare in acciaio inox sopra piano</p> <p>Top mounted stainless steel sink Evier en inox sur plan Aufgesetztes Edelstahlwaschbecken Lavabo de acero sobre encimera</p>	- 1	V1S	€ 298,00
Ø 380 - H 180 mm				
PURA (per piani prof. 600 mm)				
	<p>Lavello rettangolare in acciaio inox sopra piano</p> <p>Top mounted stainless steel sink Evier en inox sur plan Aufgesetztes Edelstahlwaschbecken Lavabo de acero sobre encimera</p>	- 2,5	V2S	€ 335,00
L 360 x P 360 x H 163 mm				
	<p>Lavello rettangolare in acciaio inox a filo piano (per piani in Corian® e stratificato)</p> <p>Stainless steel sink (for Corian® and stratified top) Evier en inox collée sous le plan (pour plans en Corian® et stratifié) Edelstahlwaschbecken bündig mit der Arbeitsplatte (für Arbeitsplatte aus Corian® und Schichtstoff) Lavabo de acero a ras de la encimera (para encimeras de Corian® o estratificado)</p>	- 4,5	V2SF	€ 725,00
L 340 x P 400 x H 200 mm				
	<p>Lavello in acciaio inox e sgocciolatoio da incasso</p> <p>Stainless steel sink with draining board Evier en inox avec égouttoir Edelstahlwaschbecken mit Abtropfblech Lavabo de acero con escurridor</p>	- 3,5	V3S	€ 349,00
L 860 x P 500 x H 170 mm				
	<p>Lavello in acciaio inox con vaschetta e sgocciolatoio sopra piano (per mobile sottolavello L 1000)</p> <p>Stainless steel sink with draining board (for sink unit L 1000) Evier en inox avec égouttoir (pour module lavabo L 1000) Edelstahlwaschbecken mit Abtropfblech (für Waschbeckenschrank L 1000) Lavabo de acero con escurridor (para módulo lavabo L 1000)</p>	- 4,5	V4S	€ 478,00
L 970 x P 500 x H 170 mm				

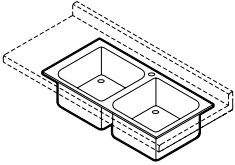
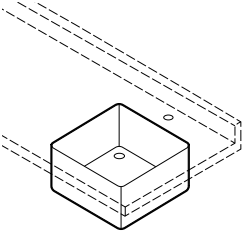
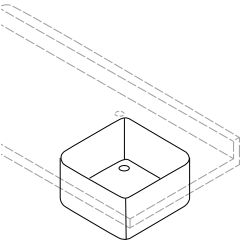
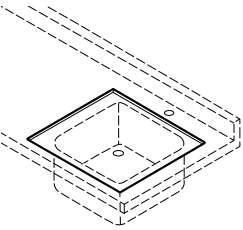
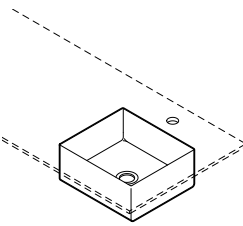
	Descrizione / Description Description / Beschreibung / Descripción	M³ Kg	Articolo Item / Article Artikel / Artículo	Prezzo Price / Prix Preis / Precio
	<p>Doppio lavello in acciaio inox sopra piano (per mobile sottolavello L 1000)</p> <p>Double stainless steel sink (for sink unit L 1000)</p> <p>Double evier en inox (pour module lavabo L 1000)</p> <p>Doppeledelstahlwaschbecken (für Waschbeckenschrank L 1000)</p> <p>Doble lavabo de acero (para módulo lavabo L 1000)</p>	- 4,5	V5S	€ 426,00
	<p>Lavello in acciaio inox con angoli interni di raggio 10 mm incorporato al piano inox</p> <p>Stainless steel sink with 10 mm radius internal corners incorporated into the stainless steel top</p> <p>Évier en acier inox avec angles internes de 10 mm de rayon incorporé au plan en inox</p> <p>Waschbecken aus Edelstahl mit Innenecken (10 mm Radius), eingebaut in die Edelstahlplatte</p> <p>Lavabo de acero inoxidable con esquinas internas, radio 10 mm, incorporado en la encimera de acero inoxidable</p>	- 5	V1P	€ 883,00
	<p>Lavello in acciaio inox con angoli interni di raggio 30 mm incorporato al piano inox</p> <p>Stainless steel sink with 30 mm radius internal corners incorporated into the stainless steel top</p> <p>Évier en acier inox avec angles internes de 30 mm de rayon incorporé au plan en inox</p> <p>Waschbecken aus Edelstahl mit Innenecken (30 mm Radius), eingebaut in die Edelstahlplatte</p> <p>Lavabo de acero inoxidable con esquinas internas, radio 30 mm, incorporado en la encimera de acero inoxidable</p>	- 5	V1I	€ 594,00
	<p>Abbassamento per lavello in acciaio inox incorporato al piano, al metro lineare</p> <p>Lowered element for stainless steel sink incorporated into the top, per meter</p> <p>Abaissement pour évier en acier incorporé au plan, au mètre</p> <p>Vertiefung für in die Ebene eingebautes Edelstahl-Waschbecken, je Meter</p> <p>Bajada para lavabo de acero inoxidable incorporado en la encimera, al m.</p>		VAA	€ 213,00
	<p>Lavello in Corian® integrato al piano in Corian®</p> <p>Integrated Corian® sink</p> <p>Évier intégré en Corian®</p> <p>Integrierte Waschbecken aus Corian®</p> <p>Lavabo integrado de Corian®</p>		VPC	€ 1.025,00

Descrizione / Description
Description / Beschreibung / Descripción

M³
Kg

Articolo
Item / Article
Artikel / Artículo

Prezzo
Price / Prix
Preis / Precio

Per Vela, Look For / Pour / Für / Por Vela, Look

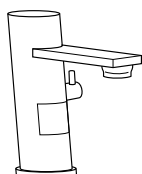

Rubinetto con fotocellula

Mixer with photoelectric cell
Robinet électronique à photocellule
Elektronische Wasserhahn mit Fotozelle
Grifo con fotocélula

-
3

RB7

€ 773,00

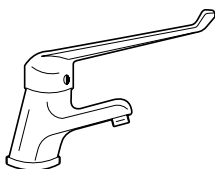

Rubinetto cromato a leva lunga (Fratelli Frattini)

Chromed mixer with long lever
Robinet chromé à levier long
Verchromte Wasserhahn mit langem Hebel
Grifo cromado con palanca larga

-
1,5

RB2

€ 183,00

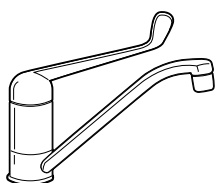

Rubinetto cromato con collo lungo e leva lunga (Fratelli Frattini)

Chromed mixer with long neck and long lever
Robinet chromé à col long et levier long
Verchromte Langrohr- und Langhebel-Wasserhahn
Grifo cromado con caño largo y palanca larga

-
1,5

RB3

€ 221,00

Universale Universal / Universel/ Universal / Universal

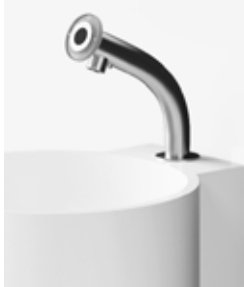

Rubinetto a fotocellula con dispensatore di sapone integrato (Miscea)



Photocell tap with integrated soap dispenser (Miscea)
Robinet à cellule photoélectrique avec distributeur de savon intégré (Miscea)
Fotocellenmischer mit integriertem Seifenspender (Miscea)
Grifo con fotocélula y dispensador de jabón integrado (Miscea)

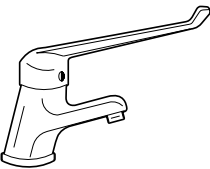
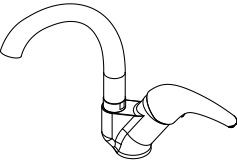
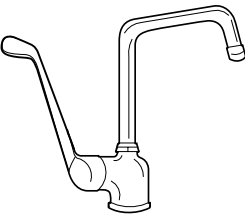
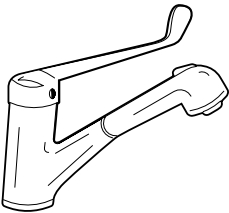
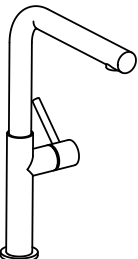

Disponibile per la nostra gamma prodotti

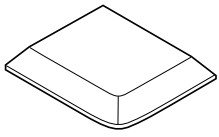
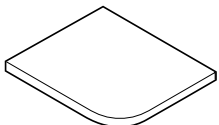
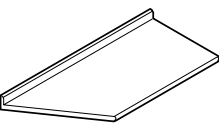
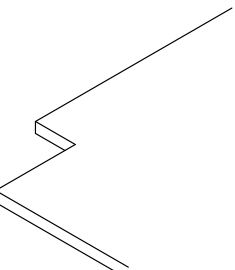
Available for our product range
Disponible pour notre gamme de produits
Für unsere Produktpalette erhältlich
Disponible para nuestra gama de productos

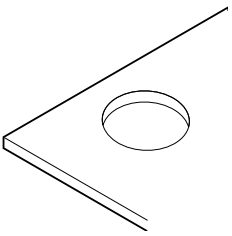
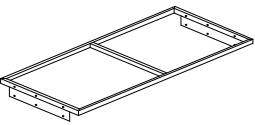
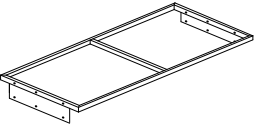

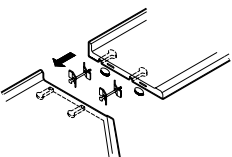

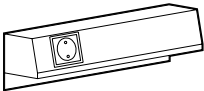
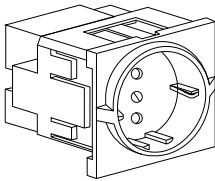
	Descrizione / Description Description / Beschreibung / Descripción	M³ Kg	Articolo Item / Article Artikel / Artículo	Prezzo Price / Prix Preis / Precio
Per Like For / Pour/ Für / Por Like				
	<p>Rubinetto monocomando con leva clinica (Rubinetterie Mariani)</p> <p>Single-control faucet with clinic handle Robinet monocommande avec levier clinique Einhebelmischer mit Klinikhebel Grifo monomando con palanca clínica</p>	- 1,5	RB12	€ 119,00
Per Steril K For / Pour/ Für / Por Steril K				
	<p>Rubinetto cromato con collo alto</p> <p>Chromed mixer Robinet chromé Verchromte Wasserhahn Grifo cromado</p>	- 1,5	RB14	€ 129,00
Per Pura, Steril K For / Pour/ Für / Por Pura, Steril K				
	<p>Rubinetto cromato con collo alto</p> <p>Chromed mixer Robinet chromé Verchromte Wasserhahn Grifo cromado</p>	- 1,5	RB4	€ 183,00
	<p>Rubinetto cromato con doccetta estraibile</p> <p>Chromed mixer with pull-out showerhead Robinet chromé avec douchette extractible Verchromte Wasserhahn mit abnehmbarer Dusche Grifo cromado con ducha extraíble</p>	- 2,7	RB5	€ 394,00
	<p>Miscelatore con collo alto</p> <p>Mixer with tall stem Mitigeur à bec haut Mischgerät mit langem Hals Mezclador con cuello alto</p>	Chromed - 1,5	RB11C	€ 462,00

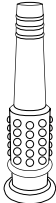
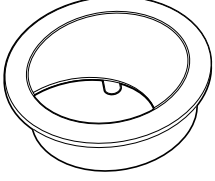
	Descrizione / Description Description / Beschreibung / Descripción	Articolo Item / Article Artikel / Artículo	Prezzo Price / Prix Preis / Precio
	Fresatura bordo piano Corian round collection Chamfered edge profile on Corian worktop, Round Collection Profil de chant chanfreiné sur plan de travail en Corian, Round Collection Fase an der Corian-Arbeitsplatte, Round Collection Perfil de canto biselado en encimera de Corian, Round Collection	FBC	€ 227,00
	Arrotondamento spigolo del piano Corner-rounding for top Angle arrondi pour le plan de travail Abgerundete Kanten der Arbeitsplatte Angulo redondeado de la encimera		
	Corian®	ARC	€ 97,00
	Vetro / Glass / Verre / Glas / Vidrio	ARV	€ 97,00
	Stratificato / Stratified / Stratifié / Schichtstoff / Estratificado	ARS	€ 97,00
	Laminato / Laminare / Laminé / Laminat / Laminado	ARP	€ 65,00
	Laminato Fenix® / Laminare Fenix® / Laminé Fenix® Laminat Fenix® / Laminado Fenix®	ARF	€ 65,00
	Acciaio inox / Stainless steel / Acier Inox Edelstahl / Acero inoxidable	ARI	€ 245,00
	Taglio obliquo su piano Special cut of top Découpe spéciale sur le plan de travail Sonderschnitt der Arbeitsplatte Corte especial sobre la encimera		
	Corian®	TSC	€ 97,00
	Vetro / Glass / Verre / Glas / Vidrio	TSV	€ 97,00
	Stratificato / Stratified / Stratifié / Schichtstoff / Estratificado	TSS	€ 97,00
	Laminato / Laminare / Laminé / Laminat / Laminado	TSP	€ 95,00
	Laminato Fenix® / Laminare Fenix® / Laminé Fenix® Laminat Fenix® / Laminado Fenix®	TSF	€ 95,00
	Acciaio inox / Stainless steel / Acier Inox Edelstahl / Acero inoxidable	TSI	€ 361,00
	Taglio a "L" su piano Special cut of top Découpe spéciale sur le plan de travail Sonderschnitt der Arbeitsplatte Corte especial sobre la encimera		
	Corian®	T1C	€ 97,00
	Vetro / Glass / Verre / Glas / Vidrio	T1V	€ 97,00
	Stratificato / Stratified / Stratifié / Schichtstoff / Estratificado	T1S	€ 97,00
	Laminato / Laminare / Laminé / Laminat / Laminado	T1P	€ 95,00
	Laminato Fenix® / Laminare Fenix® / Laminé Fenix® Laminat Fenix® / Laminado Fenix®	T1F	€ 95,00
	Acciaio inox / Stainless steel / Acier Inox Edelstahl / Acero inoxidable	T1I	€ 467,00

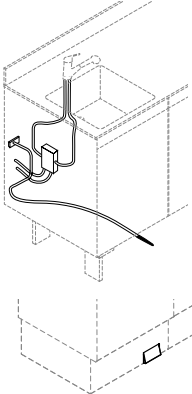
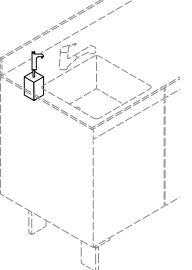
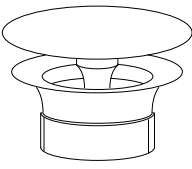
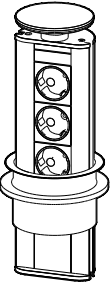
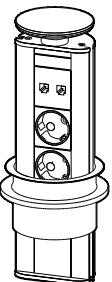

	Descrizione / Description Description / Beschreibung / Descripción	M³ Kg	Articolo Item / Article Artikel / Artículo	Prezzo Price / Prix Preis / Precio
	Foro Ø 150 mm su piano, per rifiuti Waste hole Ø 150 mm for top Trou passage déchets Ø 150 mm, pour plan Abfalloch Ø 150 mm für Arbeitsplatte Agujero Ø 150 mm para la basura, sobre encimera			
	Corian®		FRC	€ 149,00
	Vetro / Glass / Verre / Glas / Vidrio		FRV	€ 149,00
	Stratificato / Stratified / Stratifié / Schichtstoff / Estratificado		FRS	€ 149,00
	Laminato / Laminate / Laminé / Laminat / Laminado		FRT	€ 149,00
	Laminato Fenix® / Laminate Fenix® / Laminé Fenix® Laminat Fenix® / Laminado Fenix®		FRF	€ 149,00
	Acciaio inox / Stainless steel / Acier Inox Edelstahl / Acero inoxidable		FRI	€ 331,00
	Telaio supporto piano a sbalzo per piani Corian®, vetro, stratificato: al metro lineare Frame to support the top in Corian®, glass, stratified Châssis pour soutenir le plan en Corian®, verre, stratifié Rahmen für Arbeitsplatte aus Corian®, Glas, Schichtstoff Frame para apoyar las encimeras de Corian®, vidrio, estratificado			
	Minimo fatturabile: 1 metro lineare Minimum charge: 1 meter Base minimale de facturation: 1 mètre Mindestgebühr: 1 meter Mínimo facturable: 1 metro		STS	€ 184,00
	Telaio supporto piano a sbalzo per pannello laterale Cantilevered flat support frame for side panel Châssis de support plan en porte-à-faux pour panneau latéral Stützrahmen flach und vorragend für Seitenplatte Marco de soporte encimera en voladizo para panel lateral			
	Minimo fatturabile: 1 metro lineare Minimum charge: 1 meter Base minimale de facturation: 1 mètre Mindestgebühr: 1 meter Mínimo facturable: 1 metro		STG	€ 208,00
	Alzatina bianca: al metro lineare White splashback: per meter Dossieret blanc: au mètre Weiße Aufkantung: je Meter Alzada blanca: al m.			
	P 20 x H 45 mm	0,5	ALB	€ 22,00
	Set collegamento 2 piani Worktop-connection set Set pour la liaison de 2 plans de travail Set für Zusammenbau von Arbeitsplatten Juego para la unión de las 2 encimeras			
	Laminato - Laminato Fenix® Laminat - Laminat Fenix® / Laminé - Laminé Fenix® Laminat - Laminat Fenix® / Laminado - Laminado Fenix®		SCP	€ 60,00
	Acciaio inox / Stainless steel / Acier Inox / Edelstahl / Acero inoxidable		SCI	€ 165,00

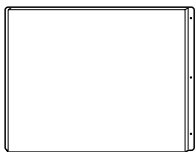
	Descrizione / Description Description / Beschreibung / Descripción	M ³ Kg	Articolo Item / Article Artikel / Artículo	Prezzo Price / Prix Preis / Precio
 Canalina tecnica: al metro lineare (min. P. 505 mm) Raceway: per meter (min. D. 505 mm) Canalisation technique: au mètre (min. P. 505 mm) Technikkanal: je Meter (min. T. 505 mm) Canal técnico: al m. (min. P. 505 mm)	Alluminio / Aluminium / Aluminium / Aluminium / Aluminio	- 1,2	CVE	€ 93,00
	Corian®	- 1,2	CCE	€ 306,00
 Preso di corrente per canalina tecnica CVE Socket for CVE Prise de courant pour CVE Steckdose für CVE Toma de corriente para CVE	Preso dati / Data socket		PDC	€ 62,00
	Preso francese / French socket		PCF	€ 37,00
	Preso svizzera / Swiss socket		PCH	€ 55,00
	Schuko		PCS	€ 37,00
	Piano estraibile con 1 preso di corrente Schuko Pull-out shelf with 1 Schuko socket Tirette avec 1 prise de courant Schuko Auszug ausgestattet mit 1 Schuko-Steckdose Estante extraíble con 1 toma de corriente Schuko	- 4	PE/3 (L 300 mm)	€ 132,00
	- 5	PE/4 (L 400 mm)	€ 158,00	
 Piano estraibile con 1 preso di corrente Schuko Pull-out shelf with 1 Schuko socket Tirette avec 1 prise de courant Schuko Auszug ausgestattet mit 1 Schuko-Steckdose Estante extraíble con 1 toma de corriente Schuko				
 Siringa aria a scomparsa sul piano Hide-away air syringe for top Soufflette air escamotable sur le plan Versenkbare Luftdüse auf der Arbeitsplatte Jeringa de aire escamoteable sobre la encimera			SAR	€ 103,00
 Boccola passacavo con chiusura Cable bush with plug Manchon passe-câbles avec fermeture Kabeldurchführung mit Verschluss Casquillo pasacables con cierre			BOP	€ 23,00

	Descrizione / Description Description / Beschreibung / Descripción	M³ Kg	Articolo Item / Article Artikel / Artículo	Prezzo Price / Prix Preis / Precio	
	<p>Kit comando elettromagnetico 24V</p> <p>24V electromagnetic control kit</p> <p>Kit commande électromagnétique 24V pour l'eau</p> <p>Elektromagnetischer Wasserauslöser 24V</p> <p>Kit de control electromagnético 24V</p>	- 1	KELV	€ 295,00	VELA LOOK LIKE ALA / QUADRO NOVO / UPRIGHT MOVINGTRAY MOVING ARM PURA PURASTUDIO
	<p>Distributore di sapone</p> <p>Soap dispenser</p> <p>Distributeur de savon</p> <p>Seifenspender</p> <p>Distribudor de jabón</p>	- 0,24	DSA	€ 128,00	STERIL K CART ARMADI
	<p>Piletta scarico libero / Click Clack</p> <p>Waste</p> <p>Fuite</p> <p>Drain</p> <p>Vaciador</p>	- -	PIL02	€ 62,00	BACINELLE PIANI ALZATINE
	<p>Colonna con 3 prese Schuko a scomparsa sul piano</p> <p>Column with 3 Schuko sockets concealable in the worktop</p> <p>Colonne avec 3 prises de courant Schuko escamotables dans le plan de travail</p> <p>Säule mit 3 Schuko-Steckdosen, voll in die Ebene integrierbar</p> <p>Columna con 3 tomas Schuko ocultas en la encimera</p>	- 0,6	CPC	€ 448,00	LAVELLI RUBINETTI LAVORAZIONI ACCESSORI
	<p>Colonna con 2 prese Schuko e 2 prese dati a scomparsa sul piano</p> <p>Column with 2 Schuko sockets and 2 data sockets concealable in the worktop</p> <p>Colonne avec 2 prises de courant Schuko et 2 prises données escamotables dans le plan</p> <p>Säule mit 2 Schuko-Steckdosen und 2 Daten-Buchsen voll in die Ebene integrierbar</p> <p>Columna con 2 tomas Schuko y 2 tomas de datos ocultas en la encimera</p>	- 0,6	CPD	€ 579,00	OPEN BOX SEGGIOLINI PROF MAESTRO

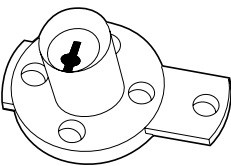
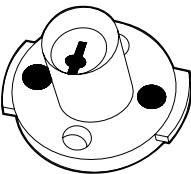
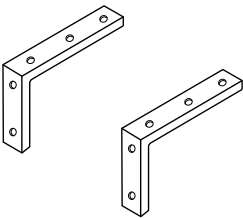
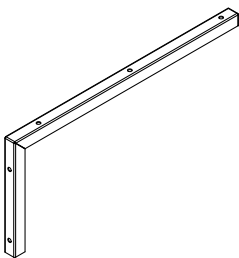
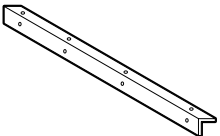
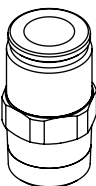
	Descrizione / Description Description / Beschreibung / Descripción	M ³ Kg	Articolo Item / Article Artikel / Artículo	Prezzo Price / Prix Preis / Precio
	<p>Pannello di chiusura da 70 a 150 mm</p> <p>Closing panel from 70 to 150 mm Cache de fermeture de 70 à 150 mm Verschlußverkleidung von 70 bis 150 mm Panel de cierre desde 70 hasta 150 mm</p>		PC1	€ 43,00
H min 330 - H max 1265 mm	<p>Disponibile anche per Steril K Also for/aussi pour/auch für/también por Steril K</p>			
	<p>Pannello di chiusura da 160 a 250 mm</p> <p>Closing panel from 160 to 250 mm Cache de fermeture de 160 à 250 mm Verschlußverkleidung von 160 bis 250 mm Panel de cierre desde 160 hasta 250 mm</p>		PC2	€ 58,00
H min 330 - H max 1265 mm	<p>Disponibile anche per Steril K Also for/aussi pour/auch für/también por Steril K</p>			
	<p>Pannello di chiusura ad angolo</p> <p>Corner closing panel Cache de fermeture pour angle Eckverschlußverkleidung Panel de cierre en ángulo</p>		PC3	€ 73,00
H min 330 - H max 1265 mm				
	<p>Pannello chiusura posteriore ai mobili: al metro lineare</p> <p>Furniture back panel: per meter Cache arrière meubles: au mètre Hintere Platte: je Meter Panel de cierre posterior: al m.</p>		PC4	€ 182,00
H min 610 - H max 918 mm				
	<p>Pannello chiusura inox fra piano e pensili: al metro lineare</p> <p>Stainless steel closing panel between top and suspended units: per meter Panneau de jonction en acier inox entre plan et éléments muraux: au mètre Edelstahlverschlußverkleidung zwischen Arbeitsplatte und Hängeschränken: je Meter Panel de cierre de acero entre encimera y elementos colgantes: al m.</p>		PC5	€ 124,00
P 20 x H 500 mm				

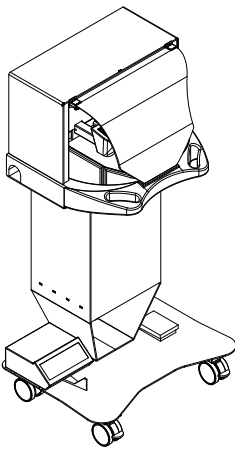
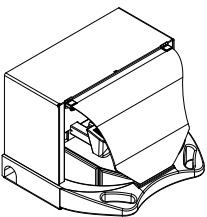
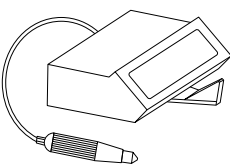
	Descrizione / Description Description / Beschreibung / Descripción	M³ Kg	Articolo Item / Article Artikel / Artículo	Prezzo Price / Prix Preis / Precio
	Serratura per serie cassetti Lock for set of drawers Serrure pour série de tiroirs Sicherheitsschloß für Schubladen Cerradura para serie de cajones		SEC	€ 144,00
	Serratura per portina o cassetto singolo Lock for door or single drawer Serrure pour portillon ou tiroir individuel Schloss für kleine Tür oder Einzelschublade Cerradura para puerta o cajón individual		SEP	€ 72,00
	Coppia staffe di sostegno mensola Double shelf brackets Paire d'équerres de support pour étagère Doppelstützbügel für Regal Par de estribos de sostén de la repisa		CSM	€ 20,00
	Supporto mensola in tubo quadro 25x25 bianco Shelf support in white square tube Support étagère en tube carré blanc Regalstütze aus weißem Quadratrohr Soporte de estante en tubo cuadrado blanco		SMC5 (P 260 mm)	€ 87,00
			SMC2 (P 320 mm)	€ 73,00
			SMC1 (P 440 mm)	€ 87,00
			SMC4 (P 540 mm)	€ 97,00
	Squadretta a "L" di sostegno piano "L" top bracket Equerre à "L" de soutien pour plan "L-förmige" Stützbügel für Arbeitsplatte Estribo en "L" de sostén de la encimera		SSL	€ 17,00
	Attacco rapido aria montato su canalina tecnica CVE Quick air connection fitted on raceway CVE Raccord rapide air monté sur canalisation technique CVE Druckluftanschluß mit Schnellkupplung für Technikkanal CVE Conexión rápida de aire montada sobre el canal técnico CVE		ARA	€ 69,00

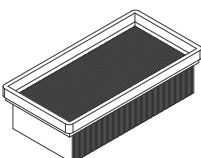
	Descrizione / Description Description / Beschreibung / Descripción	M ³ Kg	Articolo Item / Article Artikel / Artículo	Prezzo Price / Prix Preis / Precio
	<p>Banco ritocchi, completo di aspirazione, illuminazione, soffietto per aria, pulitrice ed alloggiamento per micromotore (escluso manipolo). Struttura su ruote, leggera, agile e compatta.</p> <p>Bench for retouches, equipped with suction system, lighting, air syringe, polishing machine and compartment for micromotor (MM not included). Structure on wheels, which is light, agile and compact.</p> <p>Meuble pour retouches, complet d'aspiration, éclairage, soufflette air, polisseuse et emplacement pour micromoteur (sans pièce-à-main). Structure sur roulettes, légère, agile et compacte.</p> <p>Nachbesserungstisch, Absaugvorrichtung, Beleuchtung, Luftdüse, Reinigungsgerät und Aufnahme für 1 Mikromotor (Handstück ausgenommen). Leichte, wendige und kompakte Struktur auf Rädern.</p> <p>Banco para los retoques, provisto de aspiración, iluminación, jeringa para el aire, pulidora y compartimiento para el micromotor (sin MM). Estructura ligera, ágil y compacta sobre ruedas.</p>	- ----- -	OPENBOX_1	€ 3.262,00
	<p>Banco ritocchi. Illuminazione, soffietto per aria, pulitrice ed alloggiamento per micromotore (escluso manipolo).</p> <p>Bench for retouches. Lighting, air syringe, polishing machine and compartment for micromotor (MM not included).</p> <p>Meuble pour retouches. Éclairage, soufflette air, polisseuse et emplacement pour micromoteur (sans pièce-à-main).</p> <p>Nachbesserungstisch. Beleuchtung, Luftdüse, Reinigungsgerät und Aufnahme für 1 Mikromotor (Handstück ausgenommen).</p> <p>Banco para los retoques. Iluminación, jeringa para el aire, pulidora y compartimiento para el micromotor (sin MM).</p>	- ----- -	OPENBOX_2	€ 2.151,00
	<p>Micromotore con alimentatore a pedale</p> <p>Micromotor with pedal control</p> <p>Micromoteur complet avec alimentation à pédale</p> <p>Mikromotor mit Pedalbedienung</p> <p>Micromotor con alimentador de pedal</p>	- ----- 3,5	MM	€ 1.113,00
	<p>Sacco filtro in tessuto per banco</p> <p>Tissue bag for workbench</p> <p>Sac en tissu pour établi</p> <p>Stoffsack für Arbeitstisch</p> <p>Saco de tejido para banco de trabajo</p>	- ----- -	SFT	€ 64,00
	<p>Filtro aria aspirazione A1F</p> <p>A1F intake air filter</p> <p>Filtre à air d'admission A1F</p> <p>Ansaugluftfilter A1F</p> <p>Filtro de aire de aspiración A1F</p>	- ----- -	FAA	€ 22,00

VELA

LOOK

LIKE

ALA/QUADRO
NOVO/UPRIGHT

MOVINGTRAY
MOVING ARM

PURA
PURASTUDIO

STERIL K

CART

ARMADI

BACINELLE

PIANI
ALZATINE

LAVELLI
RUBINETTI

LAVORAZIONI
ACCESSORI

OPEN BOX
SEGGIOLINI

PROF

MAESTRO

IMPIANTISTICA

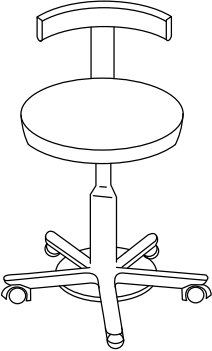
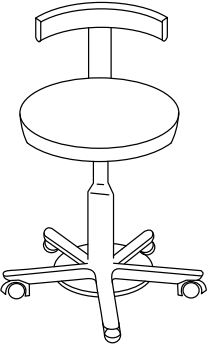
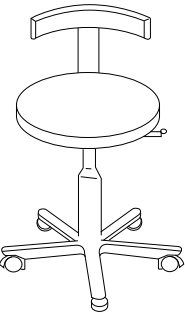
	Descrizione / Description Description / Beschreibung / Descripción	M³ Kg	Articolo Item / Article Artikel / Artículo	Prezzo Price / Prix Preis / Precio
 <p>Seggiolino per odontoiatra con schienale girevole e alzata a gas tramite pedale</p> <p>Dentist's seat with swivel back and pedal-operated height-adjustment</p> <p>Tabouret opérateur avec dossier pivotant et réglage hauteur par commande à pédale</p> <p>Zahnarztstuhl mit pendelnd gelagerter Rückenlehne und Pedalbedienung</p> <p>Silla para dentista con respaldo giratorio y mando del pedal</p> <p>H min 450 - H max 600 mm</p>	<p>0,70</p> <p>11,5</p>	SOD	€ 563,00	
 <p>Seggiolino per assistente con schienale girevole e alzata a gas tramite pedale</p> <p>Assistant's seat with swivel back and pedal-operated height-adjustment</p> <p>Tabouret assistant avec dossier pivotant et réglage hauteur par commande à pédale</p> <p>Zahnarztshelferinnenstuhl mit pendelnd gelagerter Rückenlehne und Pedalbedienung</p> <p>Silla para ayudante con respaldo giratorio y mando del pedal</p> <p>H min 550 - H max 700 mm</p>	<p>0,70</p> <p>13</p>	SOD/A	€ 582,00	
 <p>Seggiolino per odontoiatra con schienale fisso e alzata a gas tramite leva</p> <p>Dentist's seat with fixed back and lever-operated height-adjustment</p> <p>Tabouret opérateur avec dossier fixe et réglage hauteur par commande à levier</p> <p>Zahnarztstuhl mit feststehender Rückenlehne und Hebelbedienung</p> <p>Silla para dentista con respaldo fijo y mando de la palanca</p> <p>H min 550 - H max 650 mm</p>	<p>0,10</p> <p>10</p>	SOL	€ 394,00	

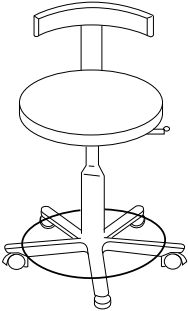
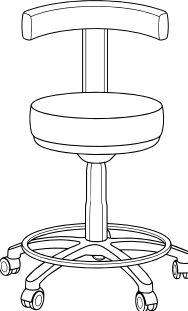
	Descrizione / Description Description / Beschreibung / Descripción	M³ Kg	Articolo Item / Article Artikel / Artículo	Prezzo Price / Prix Preis / Precio
 <p data-bbox="130 871 373 898">H min 550 - H max 650 mm</p>	<p data-bbox="411 472 900 524">Seggiolino per odontoiatra con schienale fisso, alzata a gas tramite leva e appoggiatesta</p> <p data-bbox="411 535 842 595">Dentist's seat with fixed back, lever-operated height-adjustment and footrest</p> <p data-bbox="411 607 959 667">Tabouret opérateur avec dossier fixe, réglage hauteur par commande à levier et appuie-pieds</p> <p data-bbox="411 678 855 730">Zahnarztstuhl mit feststehender Rückenlehne, Hebelbedienung und Fußstütze</p> <p data-bbox="411 741 919 792">Silla para dentista con respaldo fijo, con mando de la palanca y reposapiés</p>	0,10 ----- 11	SOL/A	€ 426,00
 <p data-bbox="130 1487 373 1514">H min 460 - H max 600 mm</p>	<p data-bbox="411 1090 991 1142">Seggiolino per odontoiatra con base cromata, schienale regolabile, alzata a gas tramite leva e appoggiatesta</p> <p data-bbox="411 1153 906 1214">Dentist seat with chrome base, adjustable backrest, gas lift and footrest ring</p> <p data-bbox="411 1225 991 1285">Tabouret pour dentiste avec base chromée, dossier réglable, vérin à gaz et repose-pieds</p> <p data-bbox="411 1296 887 1348">Zahnarztstuhl mit verchromtem Fuß, verstellbarer Rückenlehne, Gasfeder und Fußring</p> <p data-bbox="411 1359 983 1411">Taburete de dentista con base cromada, respaldo ajustable, elevación a gas y reposapiés</p>	0,10 ----- 11	SOL/C	€ 786,00

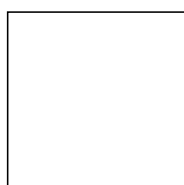

RAL 9010

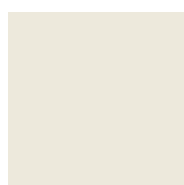

RAL 9002



RAL 7035



RAL 1015



RAL 7005



RAL 9005



RAL 1018



RAL 3022



RAL 3526



RAL 5024



RAL 5012



RAL 5005



RAL 5013



RAL 6000



RAL 6027

Questo campionario deve essere considerato solo come guida indicativa del colore e non può essere utilizzato come riferimento originale per la produzione e la valutazione di superfici colorate.

This sample should only be considered as an indicative colour guide and cannot be used as an original reference for the production and assessment of colored surfaces.

Ce nuancier ne sert qu'à donner une idée des différents coloris et ne doit en aucun cas être utilisé comme référence originale pour la production et l'évaluation des surfaces colorées.

Diese Farbmuster sind unverbindlich und können vom Original Farbton der hergestellten Oberflächen abweichen.

Esta muestra de colores debe considerarse sólo como una guía indicativa del color, y no puede utilizarse como referencia original para la producción y evaluación de las superficies pintadas.

VELA
LOOK
LIKE
ALA / QUADRO NOVO / UPRIGHT
MOVINGTRAY MOVING ARM
PURA PURASTUDIO
STERIL K
CART
ARMADI
BACINELLE
PIANI ALZATINE
LAVELLI RUBINETTI
LAVORAZIONI ACCESSORI
OPEN BOX SEGGIOLINI
PROF
MAESTRO
IMPIANTISTICA

BANCHI

Tutti i banchi hanno le seguenti dotazioni di serie:

- impianto elettrico
- predisposizione per impianto di aspirazione
- impianto aria compressa completo di siringa, manometro e riduttore di pressione
- piano superiore in laminato
- 3 prese di corrente, situate sotto la cassettera, su ogni posto di lavoro
- 2 cassetti corredati di bacinelle in PVC su ogni posto lavoro
- cassonetto con 4 cassetti

MOBILI DI SERVIZIO

Aggiungere ad ogni elemento il prezzo del supporto a pavimento o del basamento e relativi fianchi laterali dove necessari, del piano, dell'alzatina, del lavello e del rubinetto.

I moduli su misura possono essere realizzati solo con anta: applicare il prezzo dell'articolo di misura superiore con un supplemento del 25%.

CAPPE

Tutte le cappe hanno le seguenti dotazioni di serie:

- aspirazione 60 W – 600m³/h, uscita fumi Ø 150 mm
- illuminazione
- 2 prese e spine di corrente nelle cappe L. 1200 e L. 1600 mm
- chiusura con cristallo temperato scorrevole e piano in acciaio inox.
- comandi elettrici sulla parte frontale
- altezza con cristallo aperto 2400 mm

CAPPE PENSILI

Tutte le cappe pensili hanno le seguenti dotazioni di serie:

- aspirazione 300 W – 1500 m³/h con filtro in acciaio inox, uscita fumi Ø 200 mm
- illuminazione
- comandi elettrici posizionati sulla parte frontale.

Dimensioni: L = larghezza P = profondità H = altezza

BENCHES

All benches have the following standard features:

- electrical system
- predisposition for suction system
- compressed air system complete with syringe, pressure gauge and pressure reducer
- laminate-top
- 3 sockets fixed under the drawer pack, for each work station
- 2 drawers provided with PVC basins, for each work station
- drawer box with 4 drawers

SERVICE UNITS

Add the price of the floor support or base, sides, top, splashback, sink and mixer to each unit.

Made-to-measure units: apply the price of the item with the next greater size and add a 25% extra charge.

HOODS

All hoods have the following standard features:

- suction system 60W – 600m³/h, fumes exit Ø 150mm
- lighting system
- 2 sockets with plugs in the hoods L. 1200 e L. 1600mm
- hardened glass sliding door and stainless steel top
- electrical controls on the front panel
- H. 2400mm with opened glass

SUSPENDED HOODS

All suspended hoods have the following standard features:

- suction system 300W – 1500 m³/h with a stainless steel filter, fumes exit Ø 200mm
- lighting system
- electrical controls on the front panel

Dimensions: L = width P = depth H = height

ETABLIS

Tous les établis possèdent les équipements de série suivants:

- système électrique
- prédisposition pour système d'aspiration
- système d'air comprimée avec soufflette, manomètre et réducteur de pression
- dessus en mélaminé
- 3 prises de courant, positionnées sous les tiroirs, pour chaque poste de travail
- 2 tiroirs équipés de cuvettes en PVC, pour chaque poste de travail
- meuble supplémentaire avec 4 tiroirs

MODULES DE SERVICE

À chaque module il faut ajouter le prix de: support au sol, base et cotés, plan, dossier, évier et robinet.

Les modules sur mesure peuvent être réalisés uniquement avec une porte: appliquer le prix de l'article de mesure supérieure et ajouter un supplément de 25%.

HOTTES

Toutes les hottes possèdent les équipements de série suivants:

- système d'aspiration 60W – 600m³/h, sortie de la fumée Ø 150mm
- éclairage
- 2 prises de courant femelle+mâles dans les hottes L. 1200 et L. 1600mm
- fermeture avec vitre coulissante en verre trempé et dessus en acier inox
- commandes électriques positionnées sur la partie devant
- H. 2400mm avec vitre ouverte

HOTTES MURALES

Toutes les hottes murales possèdent les équipements de série suivants:

- système d'aspiration 300W – 1500m³/h avec filtre en acier inox, sortie de la fumée Ø 200mm
- éclairage
- commandes électriques positionnées sur la partie devant

Dimensions: L = largeur P = profondeur
H = hauteur

ARBEITSTISCHE

Alle Arbeitstische haben die folgende Standardausstattung:

- elektrische Installationen
- bereit zum Anschluss einer Absaugung
- Druckluftanlage, mit Luftbläser, Manometer und Druckminderer
- Laminat-Arbeitsplatte
- 3 Steckdosen unter dem Schubladensatz für jeden Arbeitsplatz
- 2 Schubladen ausgestattet mit PVC-Schubladeneinsatz für jeden Arbeitsplatz
- Schubladenkasten mit 4 Schubladen

FUNKTIONSMÖBEL

Bei jedem Element muss der Preis des Bodengestells oder Sockels und, gegebenenfalls, der jeweiligen Seiten der Ebene, der Aufkantung, des Waschbeckens und des Wasserhahns separat berechnet werden.

Maßgefertigte Module können nur mit Tür hergestellt werden: auf den Preis des nächst größeren Artikels einen Mehrpreis von 25% berechnen.

OFENSCHRÄNKE

Alle Ofenschränke haben die folgende Standardausstattung:

- Absaugvorrichtung 60W – 600m³/h
- Dampfaustritt Ø 150 mm
- Beleuchtung
- 2 Steckdosen mit Steckern in Ofenschränken B.1200 mm und B.1600 mm,
- Schiebetür aus Hartkristall und Edelstahl-Arbeitsplatte
- die Bedieneinheit befindet sich auf dem Frontpaneel.
- H. 2400 mm mit geöffneter Schiebetür.

WANDABZUGSHAUBEN

Alle Wandabzugshauben haben die folgende Standardausstattung:

- Absaugvorrichtung 300W – 1500 m³/h mit Edelstahlfilter
- Dampfaustritt Ø 200mm
- Beleuchtung
- Die Bedieneinheit befindet sich auf dem Frontpaneel

Maße: L = Breite P = Tiefe H = Höhe

BANCOS

Todos los bancos están equipados de serie como a continuación:

- instalación eléctrica
- preajuste para el equipo de aspiración
- instalación de aire comprimido provista de jeringa, manómetro y reductor de presión
- encimera superior de laminado
- instalación eléctrica con 3 tomas de corriente, posicionadas debajo de la cajonera, en cada puesto de trabajo
- 2 cajones equipados con bandejas de PVC en cada puesto de trabajo
- cajonera con 4 cajones

MUEBLES

Añadir a cada elemento el precio del soporte de pie, o de la base y de los paneles laterales, de la encimera, de la alzada, del lavabo y del grifo.

Los muebles a medida pueden realizarse sólo con la puerta: aplicar el precio del artículo de medida superior con un recargo del 25%.

CAMPANAS

Las campanas están provistas de:

- aspiración 60W – 600m³/h
- salida de los humos Ø 150 mm
- Iluminación
- 2 tomas y enchufes de corriente (campanas A.1200 mm y A.1600 mm)
- cierre con cristal templado corredero y encimera de acero inoxidable.
- Los controles están situados sobre el panel frontal.
- Alto 2400 mm con cristal templado corredero abierto.

CAMPANAS COLGANTES

Las campanas colgantes están provistas de:

- aspiración 300W – 1500 m³/h con filtro de acero inoxidable
- salida de los humos Ø 200mm
- Iluminación
- los controles están situados sobre el panel frontal

Dimensiones: L = Ancho P = Profundidad
H = Alto

VERSIONE STANDARD

Struttura: Ral 9010 opaco

Frontale: Ral 1013 opaco / Ral 5014 opaco / Ral 6021 opaco / Ral 7036 opaco / Ral 7044 opaco / Ral 9010 opaco
Colori diversi in scala Ral supplemento del 5% *
Colori metallizzati o non Ral: supplemento del 10% *

* Per i colori, vedi tabella RAL

Maniglie in alluminio anodizzato / Push-Pull

STANDARD VERSION

Carcase: Ral 9010 matt

Front: Ral 1013 matt / Ral 5014 matt / Ral 6021 matt / Ral 7036 matt / Ral 7044 matt / Ral 9010 matt

Different colours of the Ral range available with a 5% surcharge* - Metallic and non-Ral colours attract a 10% surcharge*

* For colours see RAL chart

Anodized aluminum handles / Push-Pull

VERSION STANDARD

Structure: Ral 9010 matt

Façade: Ral 1013 matt / Ral 5014 matt / Ral 6021 matt / Ral 7036 matt / Ral 7044 matt / Ral 9010 matt

Coloris différents à l'échelle Ral supplément de 5%* - Couleurs métallisées ou non Ral : supplément de 10%*

* Pour les coloris, voir tableau RAL

Poignées en aluminium anodisé / Push-Pull

STANDARDVERSION

Korpus: RAL 9010 matt

Front: Ral 1013 matt / Ral 5014 matt / Ral 6021 matt / Ral 7036 matt / Ral 7044 matt / Ral 9010 matt

Andere Farben der RAL-Farbskala Mehrpreis von 5%* - Metallic-Farben oder keine RAL-Farben: Mehrpreis von 10%*

* Farben siehe RAL-Farbtabelle

Griffe aus eloxiertem Aluminium / Push-Pull

MODELO ESTANDAR

Estructura: Ral 9010 matt

Fronte: Ral 1013 matt / Ral 5014 matt / Ral 6021 matt / Ral 7036 matt / Ral 7044 matt / Ral 9010 matt

Colores distintos en la escala Ral recargo del 5%* - Colores metalizados o no Ral: recargo del 10%*

* Para los colores, véase la tabla RAL

Tiradores de aluminio anodizado / Push-Pull

PROF | Piani Tops / Plans / Arbeitsplatte / Encimeras

I mobili di servizio sono disponibili in due versioni di piano:

- Piano laminato



- Piano Inox

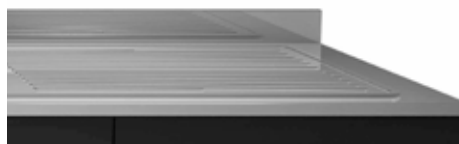

Modular service tops are available in two versions:

- Laminate top

- Stainless steel top

Les meubles de service sont disponibles en deux versions de plan:

- Plan laminé

- Plan inox

Die modular aufgebauten Funktionsmöbel sind mit zwei verschiedenen Arbeitsplatten erhältlich:

- Laminat-Arbeitsplatte

- Edelstahl-Arbeitsplatte

Los muebles están disponibles con encimera en dos versiones:

- Encimera de laminado

- Encimera de acero inoxidable

FINITURE VERNICIATE RAL OPACO

RAL matt painted finishes / Finitions vernies RAL matt / RAL matt-Lackierten Ausführungen / Acabados pintados RAL matt

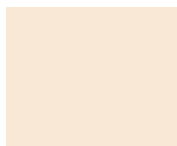

RAL 1013 OPACO



RAL 5014 OPACO



RAL 6021 OPACO



RAL 7036 OPACO



RAL 7044 OPACO

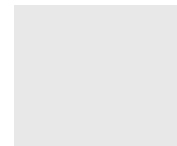

RAL 9010 OPACO

Questo campionario deve essere considerato solo come guida indicativa del colore e non può essere utilizzato come riferimento originale per la produzione e la valutazione di superfici colorate.

This sample should only be considered as an indicative colour guide and cannot be used as an original reference for the production and assessment of colored surfaces.

Ce nuancier ne sert qu'à donner une idée des différents coloris et ne doit en aucun cas être utilisé comme référence originale pour la production et l'évaluation des surfaces colorées.

Diese Farbmuster sind unverbindlich und können vom Original Farbton der hergestellten Oberflächen abweichen.

Esta muestra de colores debe considerarse sólo como una guía indicativa del color, y no puede utilizarse como referencia original para la producción y evaluación de las superficies pintadas.

PROF | Maniglie Handles / Poignées / Griffe / Tiradores

Maniglie di serie disponibili:

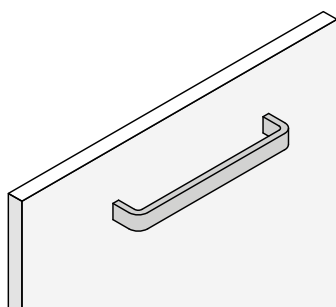

ALLUMINIO ANODIZZATO

Standard handles available:
- ANODISED ALUMINIUM
- PUSH-PULL

Poignées en série disponibles:
- ALUMINIUM ANODISÉ
- PUSH-PULL

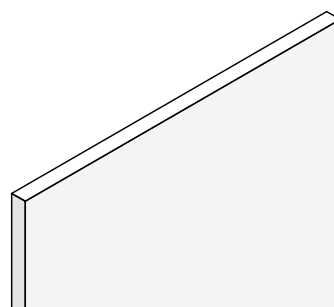

PUSH-PULL

Griffe serienmäßig erhältlich:
- ANODISIERTES ALUMINIUM
- PUSH-PULL

Tiradores de serie disponibles:
- ALUMINIO ANODIZADO
- PUSH-PULL

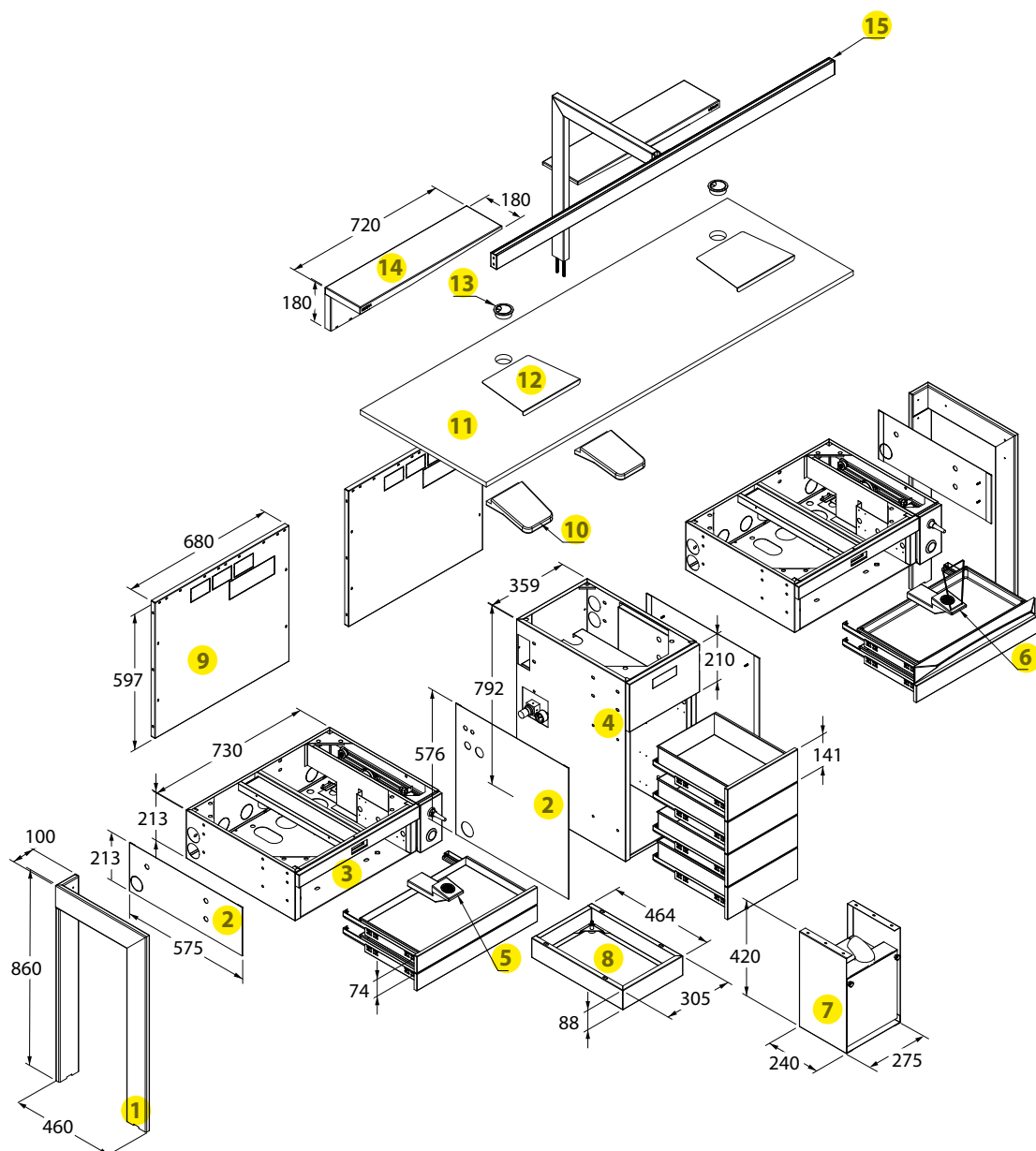

BANCO PER 2 POSTI DI LAVORO PROF

1 - Supporto laterale; 2 - Fianco laterale; 3 - Cassettiera posto lavoro; 4 - Cassonetto banco; 5 - Caviglia forata per posto lavoro con aspirazione; 6 - Caviglia forata per posto lavoro con aspirazione con protezione in vetro; 7 - Aspirazione per un posto di lavoro; 8 - Basamento; 9 - Schiena posteriore banco; 10 - Appoggiabraccia; 11 - Piano in laminato grigio; 12 - Protezione inox per posto lavoro; 13 - Boccola passacavo; 14 - Mensola soprapiano per un posto di lavoro 15 - Lampada banco due posti di lavoro.

BENCH FOR DOUBLE WORK STATION PROF

1 - Lateral support; 2 - Lateral side; 3 - Drawer pack for bench; 4 - Drawer box for bench; 5 - Perforated-peg for work station with suction apparatus; 6 - Perforated-peg for work station with suction apparatus and glass protection; 7 - Suction for one workstation; 8 - Base unit; 9 - Rear panel for bench; 10 - Armrest; 11 - Grey laminate-surfaced; 12 - Stainless steel guard for work station; 13 - Cable bushing; 14 - Shelf for one work station 15 - Lamp for 2-places bench.

ETABLI POUR DEUX POSTE DE TRAVAIL PROF

1 - Support lateral; 2 - Panneau latéral; 3 - Rangement a tiroirs pour etabli; 4 - Boite tiroirs pour etabli; 5 - Chéville perforée pour aspiration; 6 - Chéville perforée pour aspiration avec protection en verre; 7 - Aspirations pour un poste de travail; 8 - Base; 9 - Panneau arrière pour etabli; 10 - Accoudoir; 11 - Plan en laminé gris; 12 - Protéction inox pour poste de travail; 13 - Passe-câble; 14 - Etagère 15 - Lampe pour etabli 2 postes.

DOPELARBEITSTISCH PROF

1 - Seitenpanel zum Abstützen; 2 - Seitenwand; 3 - Schubladenschrank für Tisch; 4 - Schubladenbox für Tisch; 5 - Feilkloben mit Absaugmaul; 6 - Feilkloben mit Absaugmaul und Glasschutz; 7 - Ansaugung für eine Arbeitsstation; 8 - Sockel; 9 - Rückseite für Tisch; 10 - Armlehne; 11 - Grau Laminatarbeitsplatte; 12 - Edelstahlarbeitenunterlage; 13 - Kabeldurchführung; 14 - Regal 15 - Lampe für Tisch Doppelarbeitstisch.

MESA PARA DOS PUESTOS DE TRABAJO PROF

1 - Soporte lateral; 2 - Panel lateral; 3 - Cajonera para mesa; 4 - Caja para mesa; 5 - Clavija perforada para puesto de trabajo con aspiración; 6 - Clavija perforada para puesto de trabajo con aspiración y protección de vidrio; 7 - Aspiración para un puesto de trabajo; 8 - Base; 9 - Panel posterior por banco; 10 - Apoyabrazos; 11 - Tablero de laminado gris; 12 - Protección de acero inoxidable para el puesto de trabajo; 13 - Pasacables; 14 - Estante 14 - Lámpara para mesa 2-plazas.

H Sottopiano: / H Under the top: / H Sous plan de travail: / H Unter der Arbeitsplatte: / A Bajo encimera: 900 mm

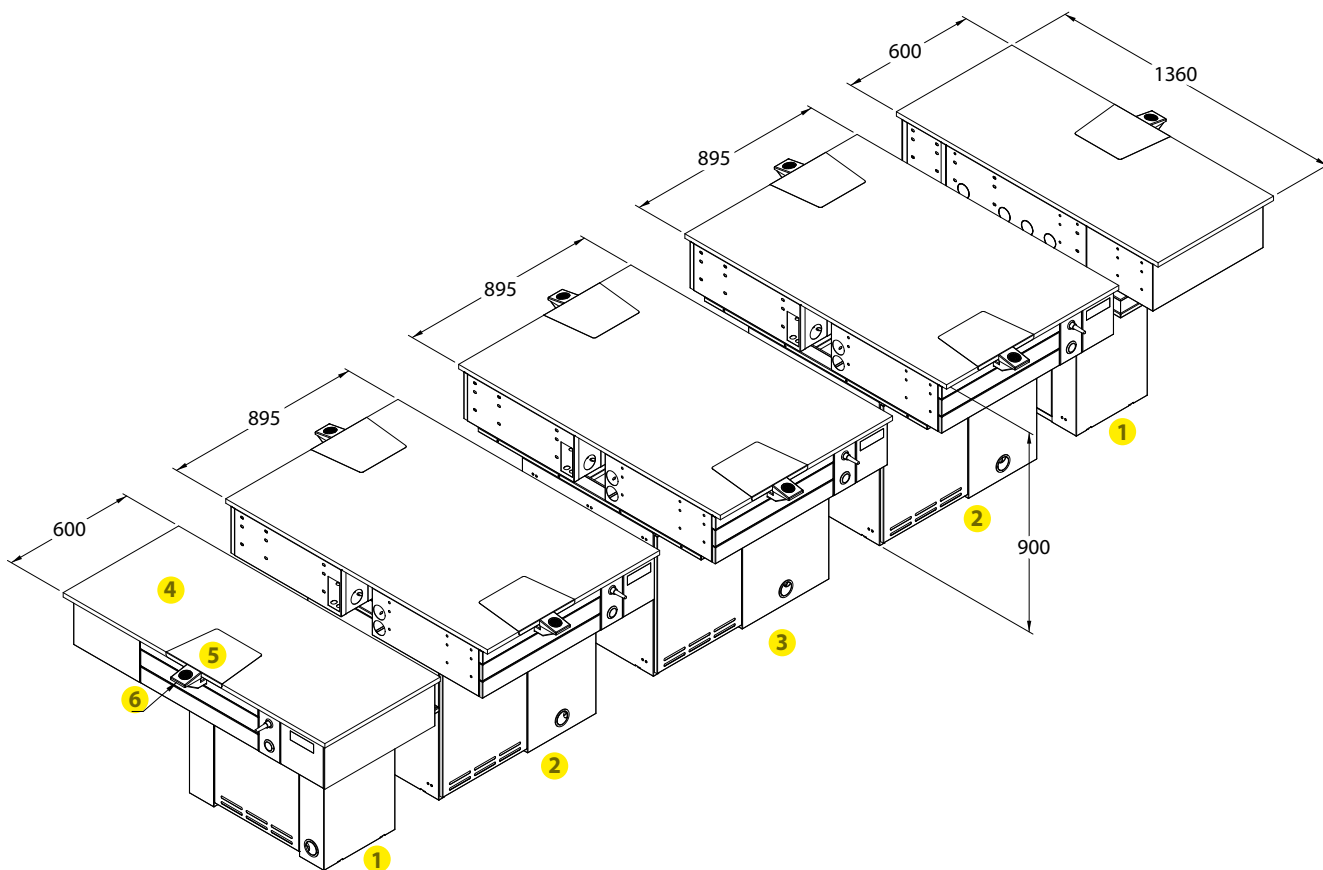

ISOLA PROF

1 - Elemento di testa isola **2** - Elemento intermedio / terminale isola; **3** - Elemento centrale isola; **4** - Piano in laminato grigio; **5** - Protezione inox per posto lavoro; **6** - Caviglia forata per posto lavoro con aspirazione.

ISLAND PROF

1 - Initial element Island; **2** - Intermediate/final element Island; **3** - Central element Island; **4** - Grey laminate-surfaced; **5** - Stainless steel guard for work station; **6** - Perforated-peg for work station with suction apparatus.

ÎLÔT PROF

1 - Élément initial Îlôt; **2** - Élément intermédiaire/final Îlôt; **3** - Élément central Îlôt; **4** - Plan en laminé gris; **5** - Protection inox pour poste de travail; **6** - Chéville perforée pour aspiration.

INSEL PROF

1 - Insel Anfangselement ; **2** - Insel Zwischen-/Endelement; **3** - Insel Zentrales Element; **4** - Grau Laminarbeitsplatte; **5** - Edelstahlarbeitenunterlage; **6** - Feilkloben mit Absaugmaul.

ISLA PROF

1 - Elemento inicial Isla; **2** - Elemento intermedio/final Isla; **3** - Elemento central Isla; **4** - Tablero de laminado gris; **5** - Protección de acero inoxidable para el puesto de trabajo; **6** - Clavija perforada para puesto de trabajo con aspiración.

H Sottopiano: / H Under the top: / H Sous plan de travail: / H Unter der Arbeitsplatte: / A Bajo encimera: 900 mm

Mobile con piedini

Per gli articoli, vedi pag. 236

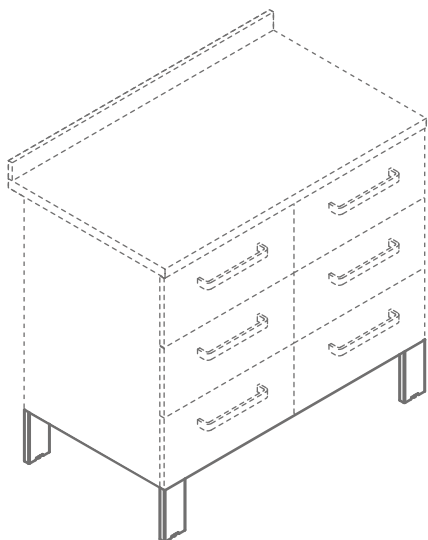

Mobile con basamento

Per gli articoli, vedi pag. 237

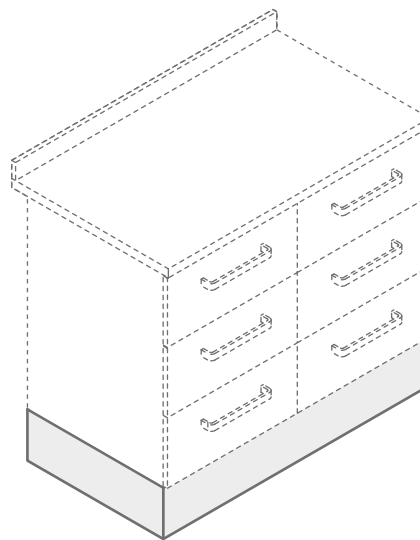

I mobili di servizio, le basi sottocappa e le cappe aspiranti devono sempre essere completati con l'aggiunta di supporti con piedini o basamenti.

Modular service units and units below suction hoods must always be fitted with feet or a basement.

Unit with feet

For more details see on page 190

Unit with basement

For more details see on page 192

Les meubles modulaires de service et les meubles sous-hotte et pour hottes aspirantes doivent toujours être complétés par l'ajout de pieds ou de bases.

Meuble avec pieds

Pour les articles, voir page 190

Meuble avec base

Pour les articles, voir page 192

Die modular aufgebauten Funktionsmöbel sowie die Möbel unter der Abzugshaube und für Abzugshauben müssen immer auf Füßen oder auf einem geschlossenen Sockel aufgestellt werden.

Möbel mit Füßen

Artikel siehe Seite 190

Möbel mit geschlossenem Sockel

Artikel siehe Seite 192

Los muebles modulares y los muebles debajo de la campana y para campanas extractoras deben siempre equiparse con patas o bases.

Mueble con patas

Para los artículos, véase la pág. 190

Mueble con base

Para los artículos, véase la pág. 192

VELA
LOOK
LIKE
ALA/QUADRO NOVO/UPRIGHT
MOVINGTRAY MOVING ARM
PURA PURASTUDIO
STERIL K
CART
ARMADI
BACINELLE
PIANI ALZATINE
LAVELLI RUBINETTI
LAVORAZIONI ACCESSORI
OPEN BOX SEGGIOLINI
PROF
MAESTRO
IMPIANTISTICA

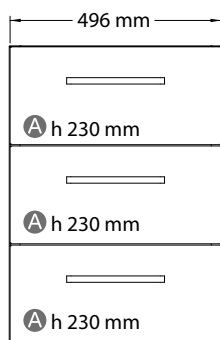
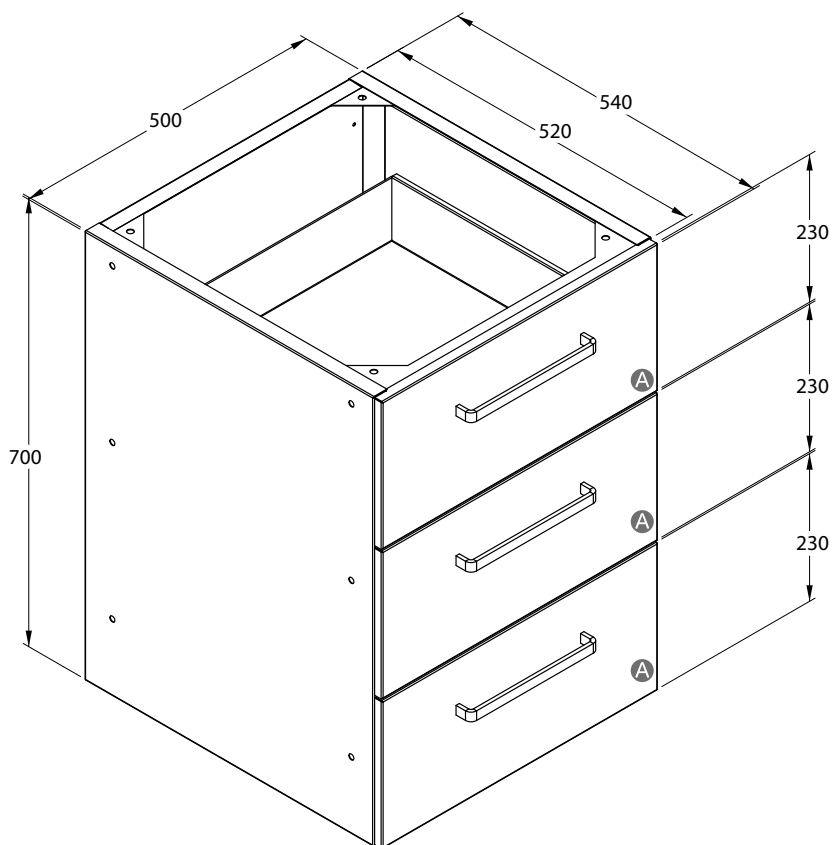

Cassetti
Drawers / Tiroirs
Schubladen / Cajones

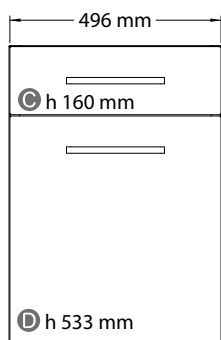

Cassetto + anta
Drawer + door / Tiroir +
porte / Schublade + Tür
Cajon + puerta

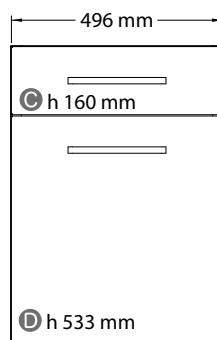

Cassetti
Drawers / Tiroirs
Schubladen / Cajones

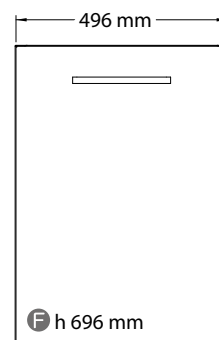

Anta
Door / Porte
Tür / Puerta

PROF | Modulari di servizio

Versione su piedi / Version on feet / Version sur pieds
Version auf Füßen / Versión con patas

LORAN

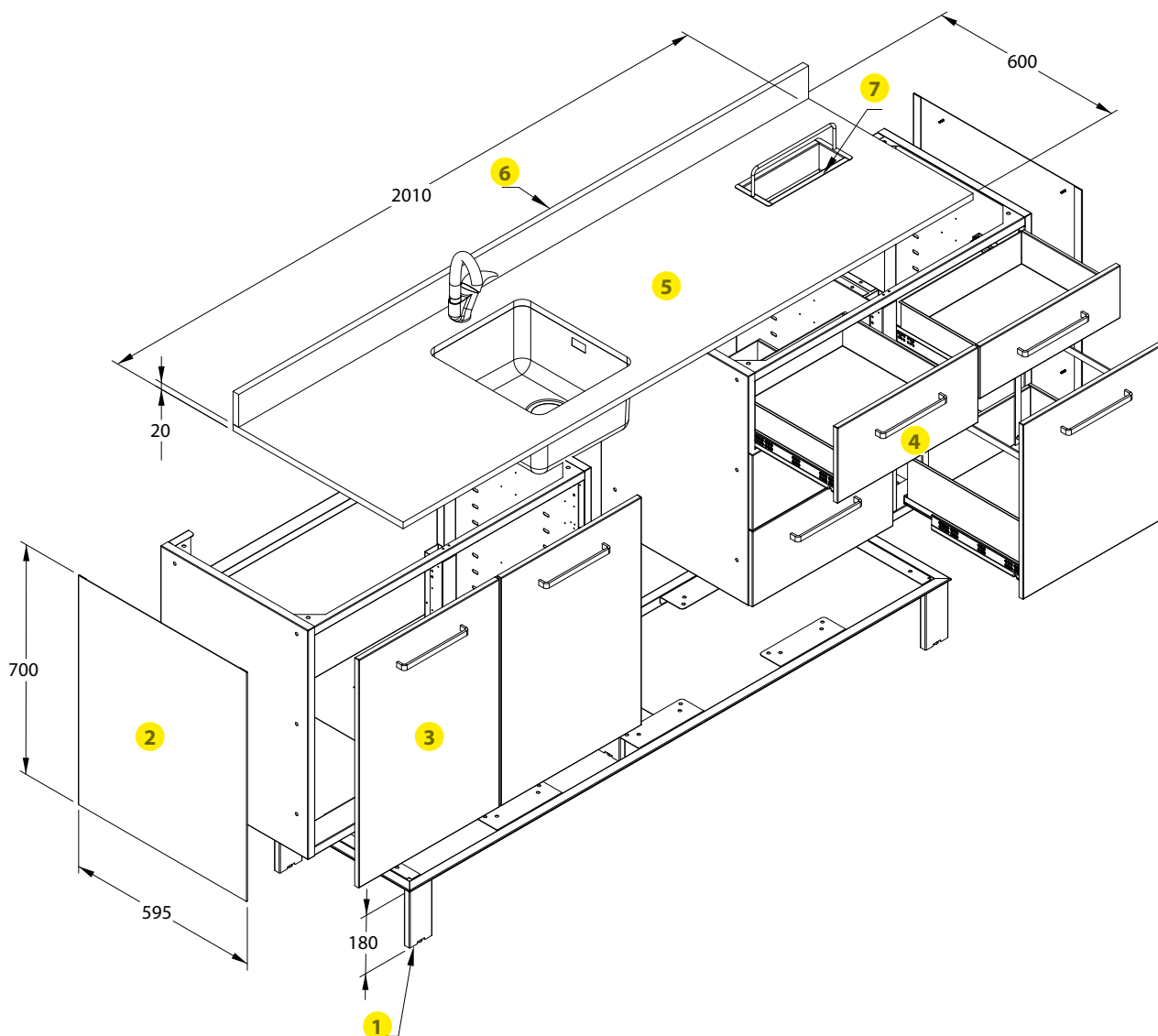

PROF

1 - Supporto a pavimento; **2** - Fianco laterale; **3** - Mobile lavello L.1000; **4** - Modulo gesso L 1000 con 3 cassetti per gesso con bacinelle in PVC, 1 cassetto per spatole, 1 cassettone portarifiuti; **5** - Piano con lavello; **6** - Alzatina inox applicata; **7** - Foro per gesso.

PROF

1 - Floor support; **2** - Lateral side; **3** - Sink unit L.1000; **4** - Plaster module L 1000 with 3 plaster drawers with PVC trays, 1 spatula drawer, 1 waste bin; **5** - Top with sink; **6** - Applied stainless steel reartrim; **7** - Plaster hole.

PROF

1 - Support au sol; **2** - Panneau latéral; **3** - Module lavabo L.1000; **4** - Module à plâtre L 1000 avec 3 tiroirs à plâtre avec plateaux PVC, 1 tiroir à spatules, 1 poubelle; **5** - Plan avec évier; **6** - Dossieret appliqué en inox; **7** - Trou de plâtre.

PROF

1 - Bodengestell; **2** - Seitenwand; **3** - Waschbeckenschrank L.1000; **4** - Gipsmodul L 1000 mit 3 Gipsschubladen mit PVC-Schalen, 1 Spachtelschublade, 1 Abfallbehälter; **5** - Arbeitsplatte mit Waschbecken; **6** - delstahlaufgeklebter Aufkantung; **7** - Mülldurchwurf;

PROF

1 - Soporte de pie; **2** - Panel lateral; **3** - Módulo bajo lavabo L.1000; **4** - Módulo de yeso L 1000 con 3 cajones para yeso con bandejas de PVC, 1 cajón para espátulas, 1 cajón de residuos; **5** - Encimera con lavabo; **6** - Elevación aplicado de acero; **7** - Agujero escayola.

H Sottopiano: / H Under the top: / H Sous plan de travail: / H Unter der Arbeitsplatte: / A Bajo encimera: 880 mm

PROF | Modulari di servizio

Versione su basamento / Version on base unit

Version sur bases / Version auf Sockel / Versión con bases

LORAN

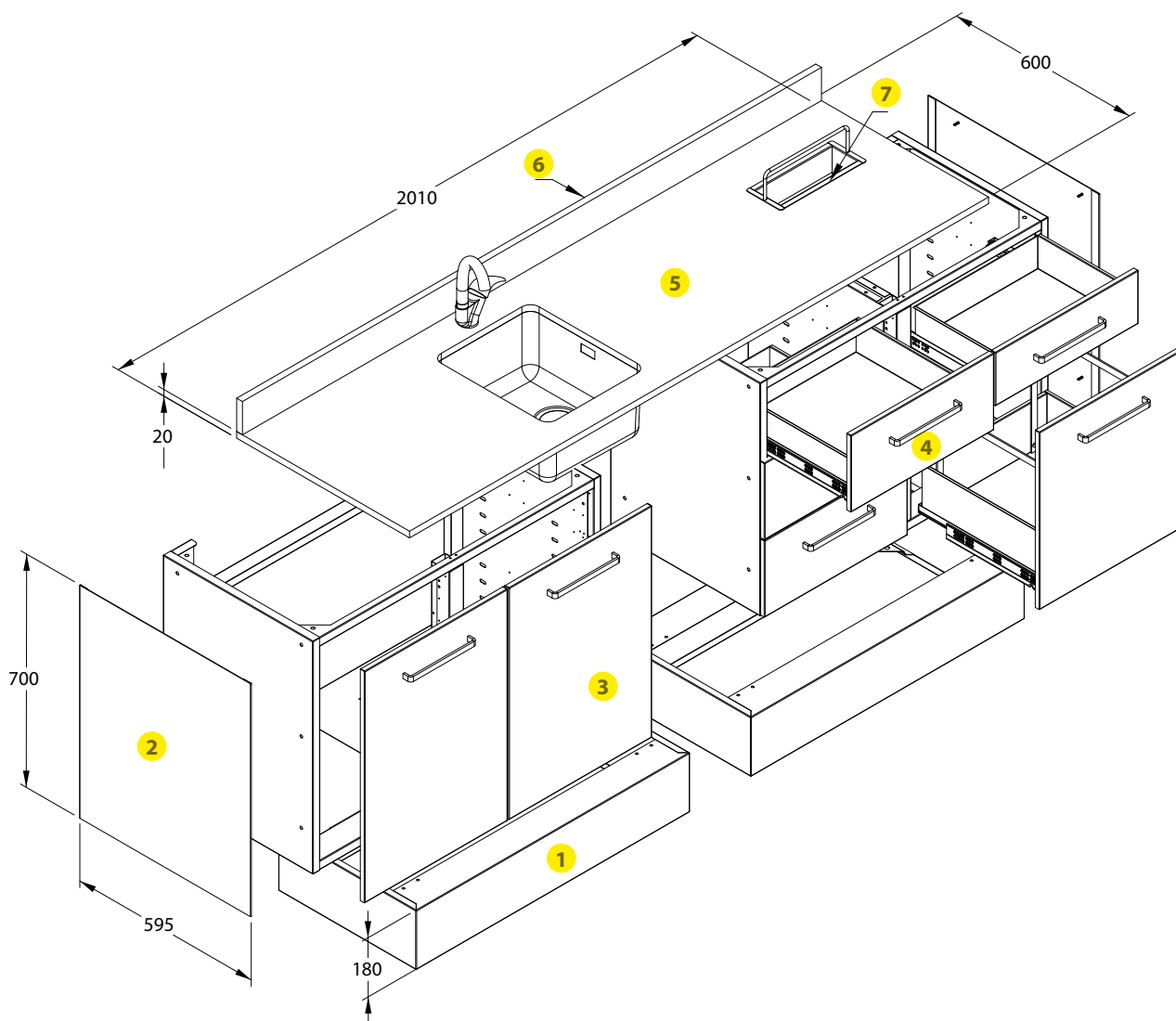

PROF

1 - Basamento; **2** - Fianco laterale; **3** - Mobile lavello L.1000; **4** - Modulo gesso L 1000 con 3 cassetti per gesso con bacinelle in PVC, 1 cassetto per spatole, 1 cassetto portarifiuti; **5** - Piano con lavello; **6** - Alzatina inox applicata; **7** - Foro per gesso.

PROF

1 - Base unit; **2** - Lateral side; **3** - Sink unit L.1000; **4** - Plaster module L 1000 with 3 plaster drawers with PVC trays, 1 spatula drawer, 1 waste bin; **5** - Top with sink; **6** - Applied stainless steel reartrim; **7** - Plaster hole.

PROF

1 - Base; **2** - Panneau latéral; **3** - Module lavabo L.1000; **4** - Module à plâtre L 1000 avec 3 tiroirs à plâtre avec plateaux PVC, 1 tiroir à spatules, 1 poubelle; **5** - Plan avec évier; **6** - Dossieret appliqué en inox; **7** - Trou de plâtre.

PROF

1 - Sockel; **2** - Seitenwand; **3** - Waschbeckenschrank L.1000; **4** - Gipsmodul L 1000 mit 3 Gipsschubladen mit PVC-Schalen, 1 Spachtelschublade, 1 Abfallbehälter; **5** - Arbeitsplatte mit Waschbecken; **6** - delstahlaufgeklebter Aufkantung; **7** - Mülldurchwurf.

PROF

1 - Base; **2** - Panel lateral; **3** - Módulo bajo lavabo L.1000; **4** - Módulo de yeso L 1000 con 3 cajones para yeso con bandejas de PVC, 1 cajón para espátulas, 1 cajón de residuos; **5** - Encimera con lavabo; **6** - Elevación aplicado de acero; **7** - Agujero escayola.

H Sottopiano: / H Under the top: / H Sous plan de travail: / H Unter der Arbeitsplatte: / A Bajo encimera: 880 mm

VELA

LOOK

LIKE

ALA / QUADRO
NOVO / UPRIGHT

MOVINGTRAY
MOVING ARM

PURA
PURASTUDIO

STERIL K

CART

ARMADI

BACINELLE

PIANI
ALZATINE

LAVELLI
RUBINETTI

LAVORAZIONI
ACCESSORI

OPEN BOX
SEGGIOLINI

PROF

MAESTRO

IMPIANTISTICA

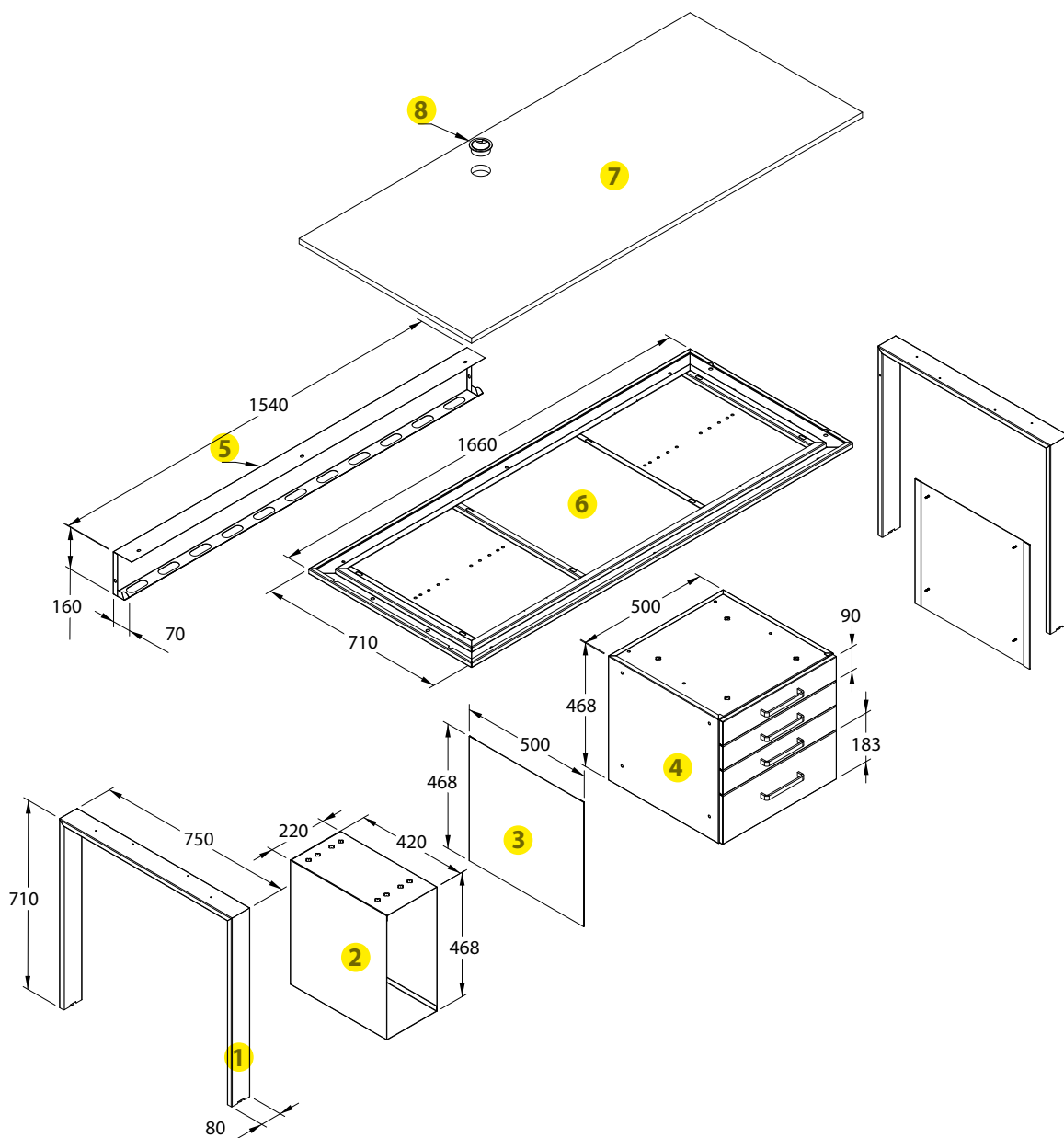

PROFWORK

1 - Supporto laterale; 2 - Supporto porta PC; 3 - Fianco laterale; 4 - Cassettiera con 4 cassetti; 5 - Schiena posteriore con passacavi; 6 - Telaio supporto piano; 7 - Piano in laminato grigio; 8 - Boccola passacavo.

PROFWORK

1 - Lateral support; 2 - PC holder; 3 - Lateral side; 4 - Drawer unit with 4 drawers; 5 - Rear back with grommet; 6 - Frame to support the top; 7 - Grey laminate-surfaced; 8 - Cable bushing.

PROFWORK

1 - Support lateral; 2 - Support pour PC; 3 - Panneau latéral; 4 - Bloc tiroirs avec 4 tiroirs; 5 - Dos arrière avec passe-câble; 6 - Châssis pour soutenir le plan; 7 - Plan en laminé gris; 8 - Passe-câble.

PROFWORK

1 - Seitenpanel zum Abstützen; 2 - PC-Halterung; 3 - Seitenwand; 4 - Schubladenblock mit 4 Schubladen; 5 - Rückwand mit Tülle; 6 - Rahmen für Arbeitsplatte; 7 - Grau Laminatarbeitsplatte; 8 - Kabeldurchführung.

PROFWORK

1 - Soporte lateral; 2 - Soporte para soporte de PC; 3 - Panel lateral; 4 - Módulo con 4 cajones; 5 - Parte trasera con guía de cable; 6 - Frame para apoyar las encimeras; 7 - Tablero de laminado gris; 8 - Pasacables.

H Sottopiano: / H Under the top: / H Sous plan de travail: / H Unter der Arbeitsplatte: / A Bajo encimera: 750 mm

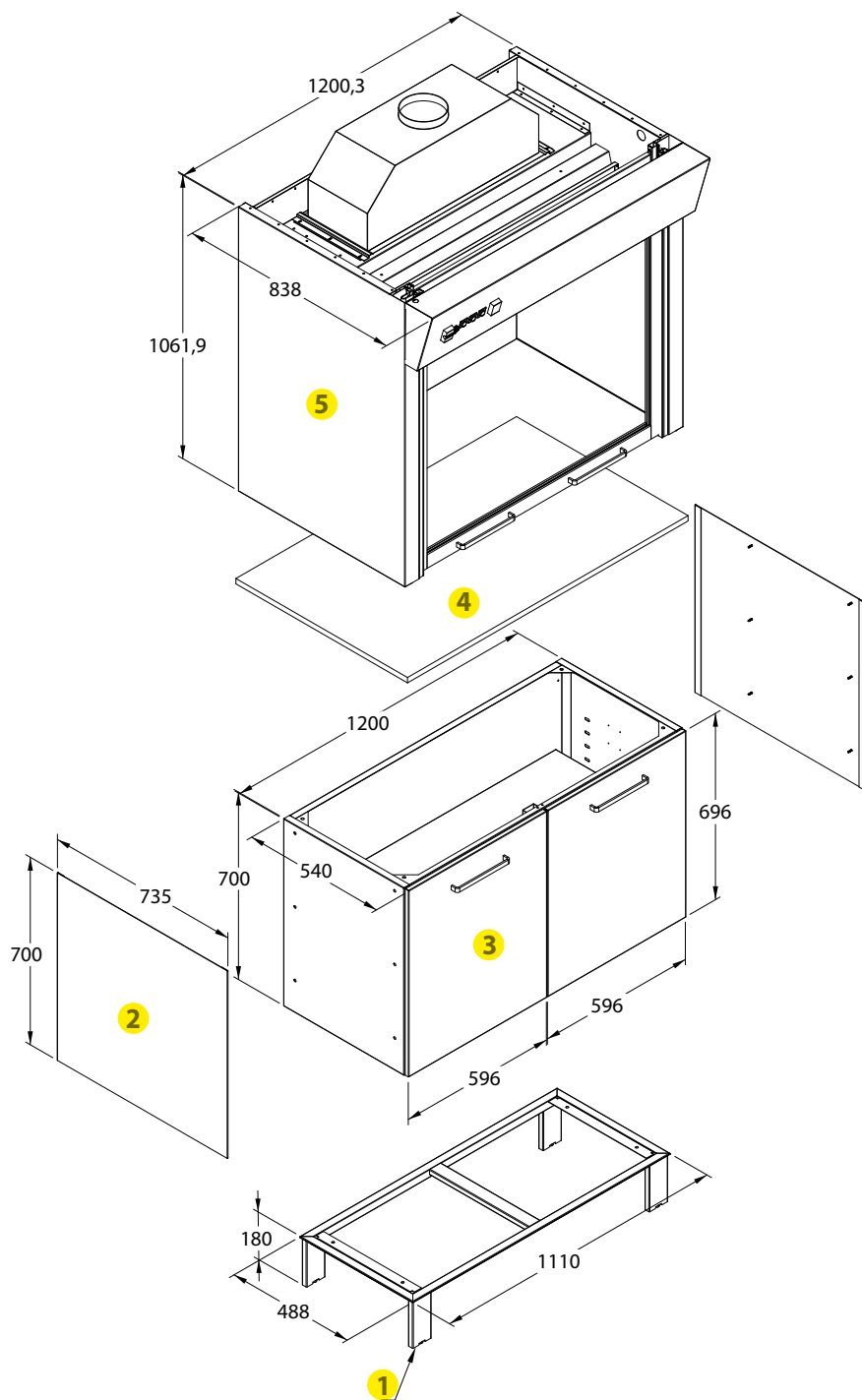

CAPPA ASPIRANTE PROF - Versione su piedi

1 - Supporto a pavimento 2 - Fianco laterale; 3 - Base sottocappa; 4 - Piano in acciaio inox; 5 - Sopracappa.

PROF SUCTION HOOD - Version on feet

1 - Floor support; 2 - Lateral side; 3 - Hood base; 4 - Stainless steel top; 5 - Upper part suction hood.

HOTTE ASPIRANTE PROF - Version sur pieds

1 - Support au sol; 2 - Panneau latéral; 3 - Partie basse pour hotte; 4 - Plan de travail inox; 5 - Partie supérieure hotte aspirante.

OFENSCHRANK PROF - Version auf Füßen

1 - Bodengestell; 2 - Seitenwand; 3 - Basis für Ofenschränk; 4 - Edelstahl-arbeitsplatte; 5 - Oberkörper Ofenschränk.

CAMPANA APSIRANTE PROF - Versión con patas

1 - Soporte de pie; 2 - Panel lateral; 3 - Elemento debajo de la campana; 4 - Encimera de acero inoxidable; 5 - Parte superior campana aspirante.

VELA

LOOK

LIKE

ALA / QUADRO
NOVO / UPRIGHTMOVINGTRAY
MOVING ARMPURA
PURASTUDIO

STERIL K

CART

ARMADI

BACINELLE

PIANI
ALZATINELAVELLI
RUBINETTILAVORAZIONI
ACCESSORIOPEN BOX
SEGGIOLINI

PROF

MAESTRO

IMPIANTISTICA

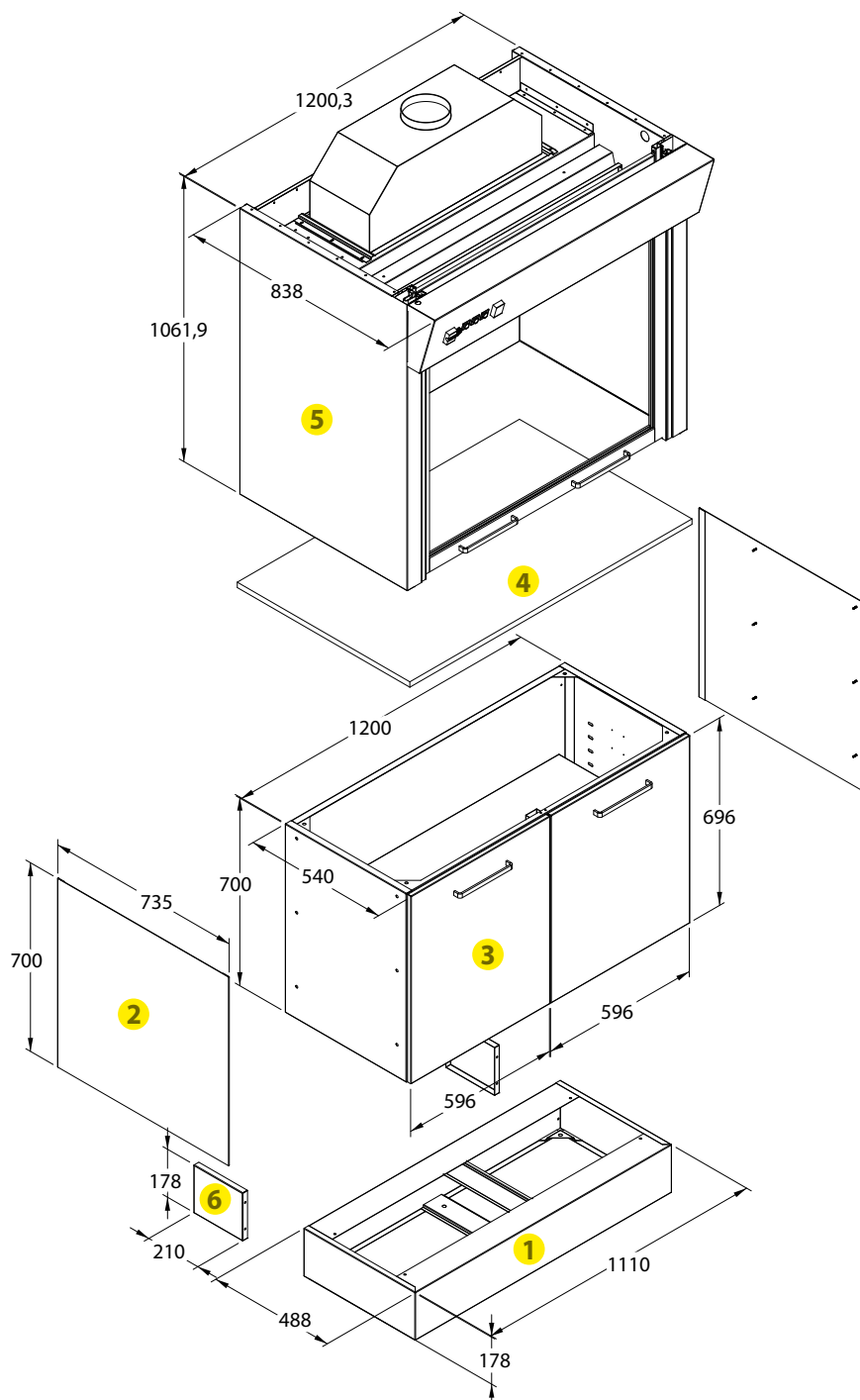

CAPPA ASPIRANTE PROF - Versione su basamento

1 - Basamento 2 - Fianco laterale; 3 - Base sottocappa; 4 - Piano in acciaio inox; 5 - Sopracappa; 6 - Tamponamento posteriore.

PROF SUCTION HOOD - Version on base unit

1 - Base unit; 2 - Lateral side; 3 - Hood base; 4 - Stainless steel top; 5 - Upper part suction hood; 6 - Closing panel.

HOTTE ASPIRANTE PROF - Version sur bases

1 - Base; 2 - Panneau latéral; 3 - Partie basse pour hotte; 4 - Plan de travail inox; 5 - Partie supérieure hotte aspirante; 6 - Cache de fermeture.

OFENSCHRANK PROF - Version auf Sockel

1 - Sockel; 2 - Seitenwand; 3 - Basis für Ofenschränk; 4 - Edelstahl arbeitsplatte; 5 - Oberkörper Ofenschränk; 6 - Verschlussverkleidung.

CAMPANA APSIRANTE PROF - Versión con bases

1 - Base; 2 - Panel lateral; 3 - Elemento debajo de la campana; 4 - Encimera de acero inoxidable; 5 - Parte superior campana aspirante; 6 - Panel de cierre.

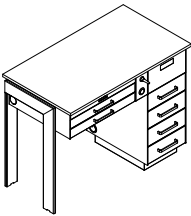
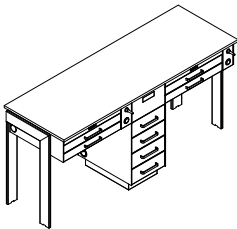
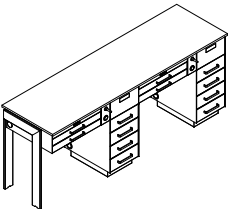
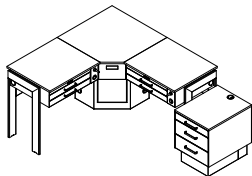
	Descrizione / Description Description / Beschreibung / Descripción	Apertura Opening / Ouverture Öffnung / Apertura	M ³ Kg	Articolo Item / Article Artikel / Artículo	Prezzo Price / Prix Preis / Precio
 <p>BANCO PER UN POSTO DI LAVORO completo di: n. 1 cassonetto</p> <p>Bench for single work station complete of: n.1 Drawer box</p> <p>Etabli pour un poste de travail complet de: n.1 Boite tiroirs</p> <p>Einzelarbeitstisch komplett mit: n.1 Schubladenbox</p> <p>Mesa para un puesto de trabajo completo de: n. 1 Caja</p> <p>L 1136 x P 640 x H 900 mm</p>	<p>Maniglia Handle Poignée Griff Tirador</p> <p>0,7 93</p> <p>PRF1M</p> <p>€ 2.451,00</p>				
	<p>Push-Pull</p> <p>0,7 93</p> <p>PRF1P</p> <p>€ 2.512,00</p>				
 <p>BANCO PER DUE POSTI DI LAVORO completo di: n. 1 cassonetto</p> <p>Bench for double work station complete of: n.1 Drawer box</p> <p>Etabli pour deux poste de travail complet de: n.1 Boite tiroirs</p> <p>Doppelarbeitstisch komplett mit: n.1 Schubladenbox</p> <p>Mesa para dos puestos de trabajo completo de: n. 1 Caja</p> <p>L 1866 x P 640 x H 900 mm</p>	<p>Maniglia Handle Poignée Griff Tirador</p> <p>1,1 128</p> <p>PRF2M</p> <p>€ 3.459,00</p>				
	<p>Push-Pull</p> <p>1,1 128</p> <p>PRF2P</p> <p>€ 3.540,00</p>				
 <p>BANCO PER DUE POSTI DI LAVORO completo di: n. 2 cassonetti</p> <p>Bench for double work station complete of: n.2 Drawer boxes</p> <p>Etabli pour deux poste de travail complet de: n.2 Boites tiroirs</p> <p>Doppelarbeitstisch komplett mit: n.2 Schubladenboxen</p> <p>Mesa para dos puestos de trabajo completo de: n. 2 Cajas</p> <p>L 2226 x P 640 x H 900 mm</p>	<p>Maniglia Handle Poignée Griff Tirador</p> <p>1,3 170</p> <p>PRF2CM</p> <p>€ 4.695,00</p>				
	<p>Push-Pull</p> <p>1,3 170</p> <p>PRF2CP</p> <p>€ 4.817,00</p>				
 <p>BANCO AD ANGOLO, sdoppiato destro o sinistro, e cassonetto portaforno con vano per pompa</p> <p>Corner bench, with rh or lh corner and oven box with pump compartment</p> <p>Etabli en angle, dédoublé droit ou gauche, et tiroir pour four avec rangement de la pompe</p> <p>Ecklösung mit schrank für den keramikofen (links oder rechts) und öffnung für die pompe</p> <p>Banco en ángulo, derecho o izquierdo, y cajón portahorno con espacio para bomba</p> <p>L 1567 x P 2081 x H 900 mm</p>	<p>Maniglia Handle Poignée Griff Tirador</p> <p>3,1 148</p> <p>PRFSDM</p> <p>€ 4.946,00</p>				
	<p>Push-Pull</p> <p>3,1 148</p> <p>PRFSDP</p> <p>€ 5.017,00</p>				

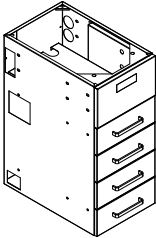
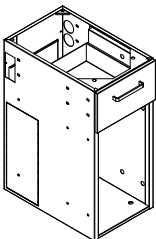
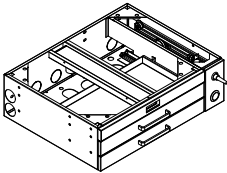
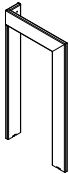
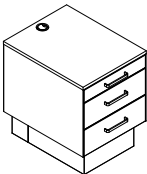
	Descrizione / Description Description / Beschreibung / Descripción	Apertura Opening / Ouverture Öffnung / Apertura	M ³ Kg	Articolo Item / Article Artikel / Artículo	Prezzo Price / Prix Preis / Precio
 <p>Cassonetto banco PROF Drawer box for bench PROF Boite tiroirs pour etabli PROF Schubladenbox für Tisch PROF Caja para mesa PROF</p> <p>L 360 x P 598 x H 792 mm</p>		Maniglia Handle Poignée Griff Tirador	0,1 35	PRCOM	€ 1.202,00
		Push-Pull	0,1 35	PRCOP	€ 1.242,00
 <p>Cassonetto banco PROF Vano Renfert Drawer box for bench PROF Boite tiroirs pour etabli PROF Schubladenbox für Tisch PROF Caja para mesa PROF</p> <p>L 360 x P 598 x H 792 mm</p>		Maniglia Handle Poignée Griff Tirador	0,1 22	PRCRM	€ 416,00
		Push-Pull	0,1 22	PRCRP	€ 426,00
 <p>Cassettiera posto lavoro banco PROF Drawer pack for bench PROF Rangement a tiroirs pour etabli PROF Schubladenschrank für Tisch PROF Cajonera para mesa PROF</p> <p>L 730 x P 598 x H 213 mm</p>		Maniglia Handle Poignée Griff Tirador	0,1 25	PRCAM	€ 680,00
		Push-Pull	0,1 25	PRCAP	€ 700,00
 <p>Supporto laterale banco PROF Lateral support for bench PROF Support lateral pour etabli PROF Seitenwand für Tisch PROF Soporte lateral para mesa PROF</p> <p>L 100 x P 460 x H 860 mm</p>			- 8	PRLB	€ 160,00
 <p>Cassonetto supplementare portaforno con vano per pompa Additional oven unit with pump compartment Petit meuble supplémentaire pour four avec rangement de la pompe Zusätzlicher Keramikofenschrank und Öffnung für die Pumpe Cajonera adicional portahorno con espacio para bomba</p> <p>L 508 x P 640 x H 660 mm</p>			0,2 40	PRFSUM	€ 809,00
			0,2 40	PRFSUP	€ 839,00

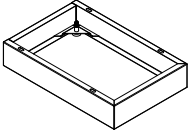
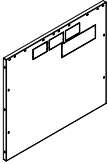
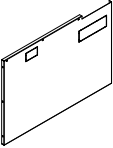
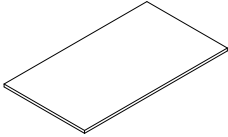
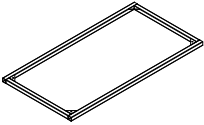

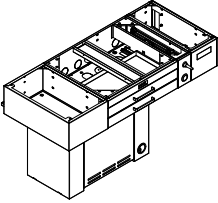
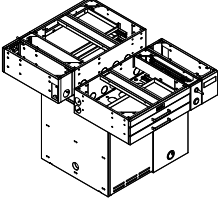
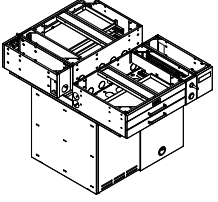
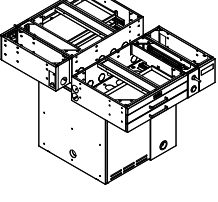
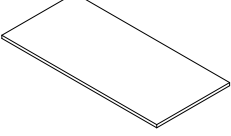
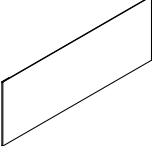
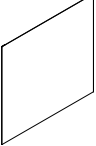

	Descrizione / Description Description / Beschreibung / Descripción	M ³ Kg	Articolo Item / Article Artikel / Artículo	Prezzo Price / Prix Preis / Precio
	<p>Basamento cassonetto banco PROF</p> <p>Base unit for drawer box PROF Base por boîte tiroirs PROF Sockel für Schubladenbox PROF Base para caja PROF</p>	- 2	PRBB	€ 51,00
L 306 x P 464 x H 90 mm				
	<p>Schiena posteriore banco lineare</p> <p>Rear panel for bench Panneau arrière pour etabli Rückseite für Tisch Panel posterior por banco</p>	- 4,5	PRSCN	€ 135,00
L 788 x P 20 x H 598 mm				
	<p>Schiena posteriore banco angolare</p> <p>Rear panel for corner bench Panneau arrière pour etabli d'angle Rückseite für EckTisch Panel posterior por banco en ángulo</p>	- 5	PRSCA	€ 160,00
L 899 x P 20 x H 610/200 mm				
	<p>Piano banco PROF: al metro lineare</p> <p>Worktop for bench PROF: per meter Dessus pour etabli PROF: au metre Arbeitsplatte für Tisch PROF: je Meter Tablero para mesa PROF: al m.</p>	- 11	PRPB	€ 210,00
L a misura x P 640 x H 20 mm				
	<p>Telaio supporto piano a sbalzo: al metro lineare</p> <p>Frame to support the top: per meter Châssis pour soutenir le plan: au metre Rahmen für Arbeitsplatte: je Meter Frame para apoyar las encimeras: al m.</p> <p>Minimo fatturabile: 1 metro lineare Minimum charge: 1 meter Base minimale de facturation: 1 mètre Mindestgebühr: 1 meter Minimo facturable: 1 metro</p>	- 11	PRTS	€ 184,00
L ---- x P ---- x H ----				

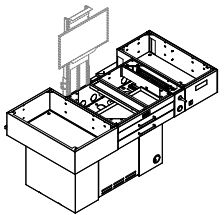
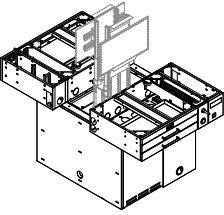
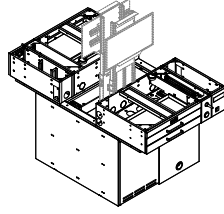
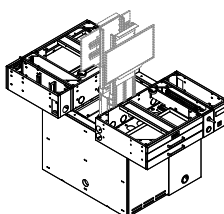
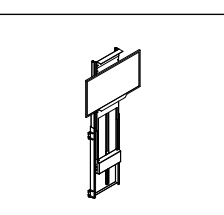
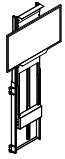
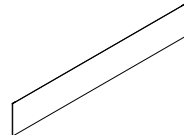
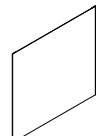
	Descrizione / Description Description / Beschreibung / Descripción	M ³ Kg	Articolo Item / Article Artikel / Artículo	Prezzo Price / Prix Preis / Precio
 L 1360 x P 695 x H 900 mm	Elemento di testa isola PROF Initial element Island Élément initial Îlot Insel Anfangselement Elemento inicial Isla	1,16 78	PRIMA	€ 1.879,00
		1,16 78	PRIPA	€ 1.919,00
 L 895 x P 1360 x H 900 mm	Elemento intermedio / terminale isola PROF Intermediate/final element Island Élément intermédiaire/final Îlot Insel Zwischen-/Endelement Elemento intermedio/final Isla	1,6 120	PRIMB	€ 3.757,00
		1,6 120	PRIPB	€ 3.838,00
 L 895 x P 1360 x H 900 mm	Elemento centrale isola PROF Central element Island Élément central Îlot Insel Zentrales Element Elemento central Isla	1,6 115	PRIMC	€ 3.757,00
		1,6 115	PRIPC	€ 3.838,00
 L 895 x P 1360 x H 900 mm	Elemento terminale / centrale 3-4 posti isola PROF Terminal/central element 3-4 seats Island Élément final/central 3-4 places Îlot Insel Terminal/Zentralelement 3-4 Plätze Elemento terminal/centro 3-4 asientos Isla	1,6 105	PRIMD	€ 3.757,00
		1,6 105	PRIPD	€ 3.838,00
 P 1360 x H 20 mm	Piano in laminato grigio bordato PVC: al metro lineare Grey laminate-surfaced. PVC edged top: per meter Plan en laminé gris avec bord en PVC: au mètre Grau Laminatarbeitsplatte mit PVCkante: je Meter Tablero de laminado gris con borde de PVC: al m.	- 26	PRIL	€ 330,00
 P 1310 x H 231 mm	Fianco finitura terminale isola Lateral side Island Panneau latéral Îlot Seitenwand Insel Panel lateral Isla	- 3,5	PRIFA	€ 64,00
 P 700 x H 646 mm	Fianco finitura terminale elemento Lateral side Island Panneau latéral Îlot Seitenwand Insel Panel lateral Isla	- 6	PRIFB	€ 64,00

Versione su ruote: rivolgersi al nostro Ufficio Commerciale / Mobile option: please contact our sales department / Option sur roulettes: veuillez contacter notre service commercial / Option mit Rollen: Bitte wenden Sie sich an unseren Vertrieb / Opción con ruedas: póngase en contacto con nuestro departamento comercial.

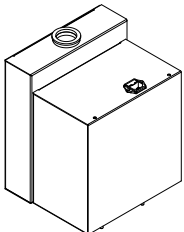
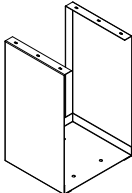
	Descrizione / Description Description / Beschreibung / Descripción	M³ Kg	Articolo Item / Article Artikel / Artículo	Prezzo Price / Prix Preis / Precio
 <p>L 1610 x P 865 x H 900 mm</p>	<p>Elemento isola di testa PROF predisposto per supporto monitor a scomparsa</p> <p>Initial element Island designed for retractable monitor support Élément initial Îlot préparé pour un support de moniteur rétractable Insel Anfangselement vorbereitet für versenkbare Monitorhalterung Elemento inicial Isla preparado para soporte de monitor retráctil</p>	1,16	PRIME	€ 2.079,00
		108		
 <p>L 895 x P 1610 x H 900 mm</p>	<p>Elemento intermedio / terminale isola PROF predisposto per supporto monitor a scomparsa</p> <p>Intermediate/final element Island designed for retractable monitor support Élément intermédiaire/final Îlot préparé pour un support de moniteur rétractable Insel Zwischen-/Endelement vorbereitet für versenkbare Monitorhalterung Elemento intermedio/final Isla preparado para soporte de monitor retráctil</p>	1,6	PRIMF	€ 3.957,00
		150		
 <p>L 895 x P 1610 x H 900 mm</p>	<p>Elemento centrale isola PROF predisposto per supporto monitor a scomparsa</p> <p>Central element Island designed for retractable monitor support Élément central Îlot préparé pour un support de moniteur rétractable Insel Zentrales Element vorbereitet für versenkbare Monitorhalterung Elemento central Isla preparado para soporte de monitor retráctil</p>	1,6	PRIMG	€ 3.957,00
		145		
 <p>L 895 x P 1610 x H 900 mm</p>	<p>Elemento terminale / centrale 3-4 posti isola PROF predisposto per supporto monitor a scomparsa</p> <p>Terminal/central element 3-4 seats Island designed for retractable monitor support Élément final/central 3-4 places Îlot préparé pour un support de moniteur rétractable Insel Terminal/Zentralelement 3-4 Plätze vorbereitet für versenkbare Monitorhalterung Elemento terminal/centro 3-4 asientos Isla preparado para soporte de monitor retráctil</p>	1,6	PRIMH	€ 3.957,00
		135		
 <p>L 895 x P 1610 x H 900 mm</p>	<p>Elemento terminale / centrale 3-4 posti isola PROF predisposto per supporto monitor a scomparsa</p> <p>Terminal/central element 3-4 seats Island designed for retractable monitor support Élément final/central 3-4 places Îlot préparé pour un support de moniteur rétractable Insel Terminal/Zentralelement 3-4 Plätze vorbereitet für versenkbare Monitorhalterung Elemento terminal/centro 3-4 asientos Isla preparado para soporte de monitor retráctil</p>	1,6	PRIPH	€ 4.038,00
		135		
	<p>Supporto monitor a scomparsa per isola PROF</p> <p>Retractable monitor support Support de moniteur rétractable Versenkbare Monitorhalterung Soporte de monitor retráctil</p>	-	PRISA	€ 1.987,00
		26		
 <p>P 1560 x H 231 mm</p>	<p>Fianco finitura terminale isola</p> <p>Lateral side Island Panneau latéral Îlot Seitenwand Insel Panel lateral Isla</p>	-	PRIFC	€ 64,00
		3,5		
 <p>P 950 x H 646 mm</p>	<p>Fianco finitura terminale elemento</p> <p>Lateral side Island Panneau latéral Îlot Seitenwand Insel Panel lateral Isla</p>	-	PRIFD	€ 64,00
		6		

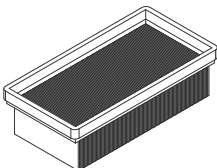
Versione su ruote: rivolgersi al nostro Ufficio Commerciale / **Mobile option:** please contact our sales department / **Option sur roulettes:** veuillez contacter notre service commercial / **Option mit Rollen:** Bitte wenden Sie sich an unseren Vertrieb / **Opción con ruedas:** póngase en contacto con nuestro departamento comercial.

	Descrizione / Description Description / Beschreibung / Descripción	M³ Kg	Articolo Item / Article Artikel / Artículo	Prezzo Price / Prix Preis / Precio
	<p>Aspirazione per 1 posto di lavoro con motore a spazzola, filtro e regolatore di giri</p> <p>Suction for one work station with motor brush, filter and revolution-control</p> <p>Aspiration à un poste de travail avec moteur à balais, filtre et tours-control</p> <p>Absaugung mit variabler Saugleistung für einen Arbeitsplatz, Filter und Drehzahlregler</p> <p>Aspiración para un puesto de trabajo, con el motor del cepillo, filtro y regulador de revoluciones</p>	- 6	A1FPR	€ 990,00
L 230 x P 240 x H 290 mm				
	<p>Supporto aspirazione A1F PROF</p> <p>A1F PROF suction support</p> <p>Support d'aspiration A1F PROF</p> <p>Absaughalterung A1F PROF</p> <p>Soporte de succión A1F PROF</p>	- 4	PRSA	€ 81,00
	<p>Sacco filtro in tessuto per banco</p> <p>Tissue bag for workbench</p> <p>Sac en tissu pour établi</p> <p>Stoffsack für Arbeitstisch</p> <p>Saco de tejido para banco de trabajo</p>	- -	SFT	€ 64,00
	<p>Filtro aria aspirazione A1F</p> <p>A1F intake air filter</p> <p>Filtre à air d'admission A1F</p> <p>Ansaugluftfilter A1F</p> <p>Filtro de aire de aspiración A1F</p>	- -	FAA	€ 22,00
	<p>Aspirazione per 1 posto di lavoro con motore a induzione (Renfert Silent Compact)</p> <p>Suction for one work station with induction (Renfert Silent Compact)</p> <p>Aspiration à un poste de travail avec moteur à induction (Renfert Silent Compact)</p> <p>Absaugung mit Induktionsmotor (Renfert Silent Compact)</p> <p>Aspiración para 1 puesto de trabajo, con el motor de inducción (Renfert Silent Compact)</p>	- -	A1R	<p>Disponibile per la nostra gamma di prodotti</p> <p>Available for our product range</p> <p>Disponible pour notre gamme de produits</p> <p>Für unsere Produktpalette erhältlich</p> <p>Disponible para nuestra gama de productos</p>

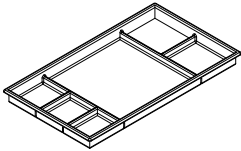
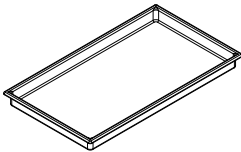
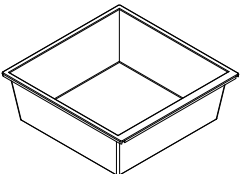
	Descrizione / Description Description / Beschreibung / Descripción	M³ Kg	Articolo Item / Article Artikel / Artículo	Prezzo Price / Prix Preis / Precio
	<p>Bacinella posto lavoro a scomparti</p> <p>Work station tray with compartments Intérieur de tiroir à compartiments Einsatz mit Fächern Bandeja para puesto de trabajo con compartimientos</p>	- 0,4	B07	€ 18,00
L 540 x P 310 x H 40 mm				
	<p>Bacinella posto lavoro liscia</p> <p>Flat work station tray Intérieur de tiroir plat Einsatz ohne Profile Bandeja plana para puesto de trabajo</p>	- 0,4	B08	€ 18,00
L 540 x P 310 x H 40 mm				
	<p>Bacinella per il gesso</p> <p>Plaster tray Intérieur de tiroir pour plâtre Einlage für Gips Bandeja para el yeso</p>	- 0,8	B10M	€ 37,00
L 430 x P 450 x H 150 mm				

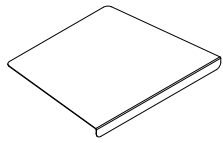
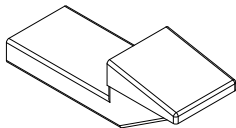
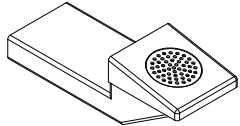
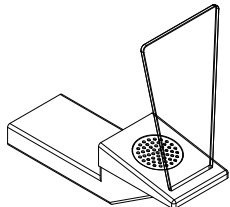
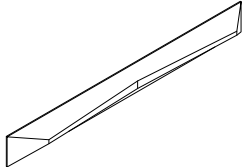
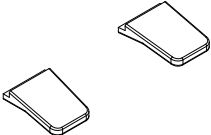
	Descrizione / Description Description / Beschreibung / Descripción	M³ Kg	Articolo Item / Article Artikel / Artículo	Prezzo Price / Prix Preis / Precio	
	<p>Protezione inox per posto lavoro</p> <p>Stainless steel guard for work station Protéction inox pour poste de travail Edeltstahlarbeitsunterlage Protección de acero inoxidable para el puesto de trabajo</p>	- 0,6	PRPI	€ 63,00	VELA LOOK LIKE ALA/QUADRO NOVO/UPRIGHT MOVINGTRAY MOVING ARM
	<p>Caviglia chiusa per posto lavoro</p> <p>Closed-peg for work station Chéville fermée en bois Feilkloben aus Holz Clavija cerrada para puesto de trabajo</p>	- 0,2	PRCC	€ 106,00	PURA PURASTUDIO STERIL K
	<p>Caviglia forata per posto lavoro con aspirazione</p> <p>Perforated-peg for work station with suction apparatus Chéville perforée pour aspiration Feilkloben mit Absaugmaul Clavija perforada para puesto de trabajo con aspiración</p>	- 0,2	PRCA	€ 116,00	CART ARMADI
	<p>Caviglia forata per posto lavoro con aspirazione con protezione in vetro</p> <p>Perforated-peg for work station with suction apparatus and glass protection Chéville perforée pour aspiration avec protection en verre Feilkloben mit Absaugmaul und Glasschutz Clavija perforada para puesto de trabajo con aspiración y protección de vidrio</p>	- 0,2	PRCV	€ 146,00	BACINELLE PIANI ALZATINE
	<p>Frontalino in legno appoggia braccia per un cassetto posto lavoro</p> <p>Front panel armrest in wood, for one drawer Façade accoudeoir en bois, pour un tiroir poste de travail Frontplatte Armstützen aus Holz, für eine Schublade Panel frontal apoyabrazos en madera, para 1 cajón del puesto de trabajo</p>	- 1	MFAL	€ 117,00	LAVELLI RUBINETTI LAVORAZIONI ACCESSORI OPEN BOX SEGGIOLINI
	<p>Coppia appoggia braccia in legno per banco Prof</p> <p>Pair of armrests Supports de bras, droit et gauche Armstützen, links und rechts Apoyabrazos</p>	- 1	PRA2	€ 137,00	PROF MAESTRO IMPIANTISTICA

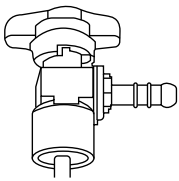
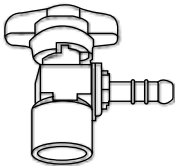
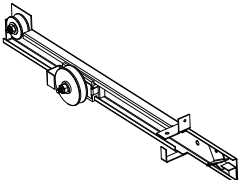
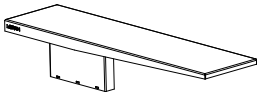
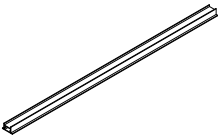
	Descrizione / Description Description / Beschreibung / Descripción	M³ Kg	Articolo Item / Article Artikel / Artículo	Prezzo Price / Prix Preis / Precio
	Rubinetto e tubo gas Gas plant and gas valve Système à gaz et robinet de gaz Vorinstallierte Gasarmaturen mit Gashahn Plantas de gas y válvula de gas	- ---	IRG	€ 94,00
	Rubinetto gas Gas cock Robinet de gaz Gashahn Grifo de gas	- ---	RUG	€ 53,00
	Sistema richiamo per micromotore PROF Retrieval system for micromotor PROF Système de retour pour micromoteur PROF Kabel-Rückholsystem für Mikromotor PROF Recuperación del sistema para micromotor PROF	- ---	PRRM	€ 254,00
	Mensola soprapiano per un posto di lavoro PROF Shelf for one work station PROF Étagère PROF Regal PROF Estante PROF	- 5	(DX) PRMD	€ 219,00
		- 5	(SX) PRMS	€ 219,00
	Lampada led per mensola banco PROF LED lamp for PROF bench shelf Llampe LED pour étagère de comptoir PROF LED-Lampe für PROF-Thekenregal Lámpara LED para estante de banco PROF	- ---	PRML	€ 172,00

L 720 x P 180 x H 180 mm

L 720 x P 180 x H 180 mm

VELA

LOOK

LIKE

ALA/QUADRO
NOVO/UPRIGHTMOVINGTRAY
MOVING ARMPURA
PURASTUDIO

STERIL K

CART

ARMADI

BACINELLE

PIANI
ALZATINELAVELLI
RUBINETTILAVORAZIONI
ACCESSORIOPEN BOX
SEGGIOLINI

PROF

MAESTRO

IMPIANTISTICA

	Descrizione / Description Description / Beschreibung / Descripción	M³ Kg	Articolo Item / Article Artikel / Artículo	Prezzo Price / Prix Preis / Precio
	<p>Lampada orientabile da un posto, alimentatore elettronico 5000K 26,2 W</p> <p>Adjustable Lamp for 1-place bench, electric power supply 5000K 26,2 W</p> <p>Lampe orientable pour établi 1 poste, alimentation électrique 5000K 26,2 W</p> <p>Schwenkbare Lampe für Tisch Einzelarbeitstisch, Leistungselektronik 5000K 26,2 W</p> <p>Lámpara orientable para mesa 1-plaza, potencia eléctrica 5000K 26,2 W</p>	0,3 10	PRL1	€ 596,00
L 950 x P 540 x H 700				
	<p>Lampada orientabile da due posti, alimentatore elettronico 5000K 47,8W</p> <p>Adjustable Lamp for 2-places bench, electric power supply 5000K 47,8 W</p> <p>Lampe orientable pour établi 2 postes, alimentation électrique 5000K 47,8 W</p> <p>Schwenkbare Lampe für Tisch Doppelarbeitstisch, Leistungselektronik 5000K 47,8 W</p> <p>Lámpara orientable para mesa 2-plazas, potencia eléctrica 5000K 47,8 W</p>	0,7 15	PRL2	€ 899,00
L 1720 x P 540 x H 700				
	<p>Lampada snodata a LED, alimentatore elettronico 5000K, 14W</p> <p>Articulated LED lamp, electronic power supply 5000K, 14W</p> <p>Lampe à led avec bras articulé, alimentation électrique 5000 K, 14 W.</p> <p>LED-Gelenklampe, elektronisches Netzteil 5000K, 14W.</p> <p>Lámpara articulada de LED, potencia eléctrica 5000 K, 14W</p>	- 2	L1S	€ 1.478,00
L 320 x P 120 x H 490				
	<p>Lampada snodata a LED Armlight Eclairé, alimentatore elettronico 6000K, 14W, 1200lm Renfort</p> <p>Articulated LED lamp, electronic power supply 6000K,14W 1200lm (Armlight Eclairé) Renfort</p> <p>Lampe à led avec bras articulé, alimentation électrique 6000K, 14W, 1200lm (Armlight Eclairé) Renfort</p> <p>LED-Gelenklampe, elektronisches Netzteil 6000K, 14W, 1200lm (Armlight Eclairé) Renfort</p> <p>Lámpara articulada de LED, potencia eléctrica 6000 K, 14W, 1200lm (Armlight Eclairé) Renfort</p>		L2S	€ 414,00
Dim. testa 40x8x2 Lunghezza (braccio) 92				

VELA

LOOK

LIKE

ALA/QUADRO
NOVO/UPRIGHTMOVINGTRAY
MOVING ARMPURA
PURASTUDIO

STERIL K

CART

ARMADI

BACINELLE

PIANI
ALZATINELAVELLI
RUBINETTILAVORAZIONI
ACCESSORIOPEN BOX
SEGGIOLINI

PROF



MAESTRO

IMPIANTISTICA

PROF | Accessori per banchi e isole

LORAN

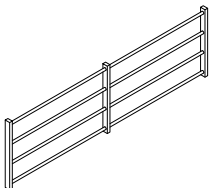
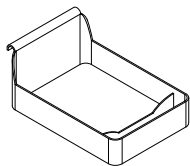
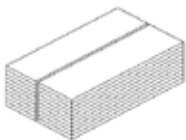
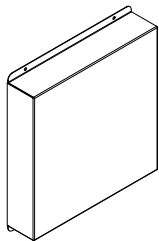
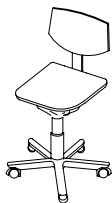
Benches accessories / Accessoires pour établis / Zubehörteile für Arbeitstische / Accesorios para bancos

	Descrizione / Description Description / Beschreibung / Descripción	M³ Kg	Articolo Item / Article Artikel / Artículo	Prezzo Price / Prix Preis / Precio
	Supporto murale per 12 bacinelle portalavori Wall-fixed 12-workpiece basin support Support mural de 12 bassinets BPL Regalschienensystem für Wandmontage (12 Arbeitschalen) Soporte de pared para 12 bandejas BPL	- 2,5	SMU	€ 146,00
L 1125 x P 25 x H 340				
	Bacinella portalavori: arancio, blu, giallo, grigio, rosso, verde Workpiece basin: orange, blue, yellow, grey, red, green Bassinets porte travail: orange, bleu, jaune, gris, rouge, vert Arbeitschale: orange, blau, gelb, grau, rot, grün Bandeja portatrabajo: anaranjada, azul, amarilla, gris, roja, verde	- 0,25	BPL	€ 14,00
L 170 x P 235 x H 110				
	Confezione con 50 etichette per bacinelle portalavori 50 label-pack for workpiece basins Paquet de 50 etiquettes pour bassinets porte travail Etikette für Arbeitschalen (50 Stck.) Paquete de 50 etiquetas para bandejas portatrabajo	- -	CEP	€ 6,00
	Supporto per reostato a ginocchio per banco Knee operated rheostat support for bench Support à genou pour micromoteur, pour établi Knieanlasserbleche für Tisch Soporte de codillo del reóstato para el banco	- 1,3	SRG	€ 53,00
	Seggiolino in faggio naturale Natural beech stool Siège de travail en bois naturel Arbeitsstuhl aus Buche natur Silla en madera de haya natural	0,7 15	SEL Naturale natural naturel natur natural	€ 299,00
L 430 x P 520 x H 900		0,7 15	SELB Laccato bianco white blanc weiß blanco	€ 322,00
	Seggiolino grigio Score Spirit 1500 Score Spirit 1500 grey stool Siège de travail gris Score Spirit 1500 Grauer Arbeitsstuhl Score Spirit 1500 Silla gris Score Spirit 1500	0,2 9	SELS	€ 554,00
L 430 x P 520 x H 850 mm				

VELA

LOOK

LIKE

ALA/QUADRO
NOVO/UPRIGHTMOVINGTRAY
MOVING ARMPURA
PURASTUDIO

STERIL K

CART

ARMADI

BACINELLE

PIANI
ALZATINELAVELLI
RUBINETTILAVORAZIONI
ACCESSORIOPEN BOX
SEGGIOLINI

PROF

MAESTRO

IMPIANTISTICA

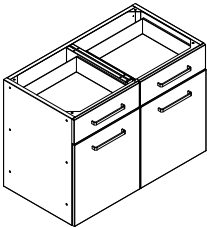
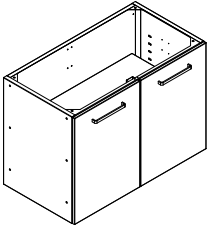
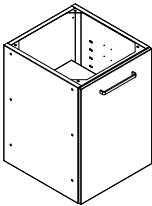
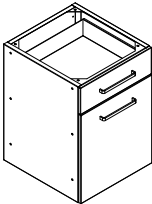
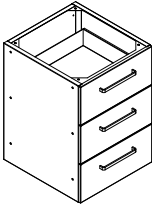
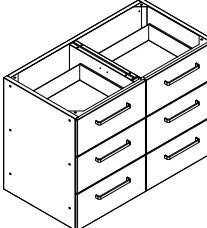
	Descrizione / Description Description / Beschreibung / Descripción	Apertura Opening / Ouverture Öffnung / Apertura	M ³ Kg	Articolo Item / Article Artikel / Artículo	Prezzo Price / Prix Preis / Precio
 <p>Modulare completo di 2 cassetti, 2 antine e ripiano interno Unit with 2 drawers, 2 doors and an interior shelf Module avec 2 tiroirs, 2 portes et 1 étagère interne Schrank mit 2 Schubladen und 2 Türen mit 1 Einlegeboden Módulo con 2 cajones, 2 puertas y 1 estante interior</p> <p>L 1000 x P 540 x H 700 mm</p>	Maniglia Handle Poignée Griff Tirador	0,4 58	PR01M	€ 1.082,00	
	Push-Pull	0,4 58	PR01P	€ 1.122,00	
 <p>Modulare completo di due antine e ripiano interno Unit with 2 doors and an interior shelf Module avec 2 portes avec 1 étagère interne Schrank mit 2 Türen mit 1 Einlegeboden Módulo con 2 puertas y 1 estante interior</p> <p>L 1000 x P 540 x H 700 mm</p>	Maniglia Handle Poignée Griff Tirador	0,4 48	PR02M	€ 930,00	
	Push-Pull	0,4 48	PR02P	€ 971,00	
 <p>Modulare completo di antina e ripiano interno Unit with door and an interior shelf Module avec porte avec 1 étagère interne Schrank mit Tür mit 1 Einlegeboden Módulo con 1 puerta y 1 estante interior</p> <p>L 500 x P 540 x H 700 mm</p>	Maniglia Handle Poignée Griff Tirador	0,2 30	PR03M	€ 628,00	
	Push-Pull	0,2 30	PR03P	€ 648,00	
 <p>Modulare completo di cassetto, antina e ripiano interno Unit with drawer, door and an interior shelf Module avec tiroir et porte avec 1 étagère interne Schrank mit 1 Schublade und 1 Tür mit 1 Einlegeboden Módulo con 1 cajón, 1 puerta y 1 estante interior</p> <p>L 500 x P 540 x H 700 mm</p>	Maniglia Handle Poignée Griff Tirador	0,2 34	PR04M	€ 690,00	
	Push-Pull	0,2 34	PR04P	€ 730,00	
 <p>Modulare completo di 3 cassetti Unit with 3 drawers Module avec 3 tiroirs Schrank mit 3 Schubladen Módulo con 3 cajones</p> <p>L 500 x P 540 x H 700 mm</p>	Maniglia Handle Poignée Griff Tirador	0,2 45	PR05M	€ 831,00	
	Push-Pull	0,2 45	PR05P	€ 892,00	
 <p>Modulare completo di 6 cassetti Unit with 6 drawers Module avec 6 tiroirs Schrank mit 6 Schubladen Módulo con 6 cajones</p> <p>L1000 x P 540 x H 700 mm</p>		0,4 85	PR06M	€ 1.268,00	
		0,4 85	PR06P	€ 1.389,00	

VELA

LOOK

LIKE

ALA/QUADRO
NOVO/UPRIGHTMOVINGTRAY
MOVING ARMPURA
PURASTUDIO

STERIL K

CART

ARMADI

BACINELLE

PIANI
ALZATINELAVELLI
RUBINETTILAVORAZIONI
ACCESSORIOPEN BOX
SEGGIOLINI

PROF

MAESTRO

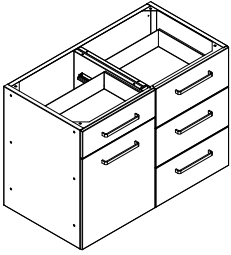
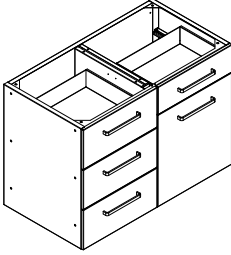
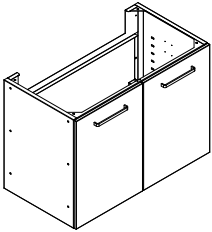
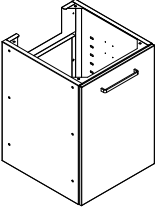

IMPIANTISTICA

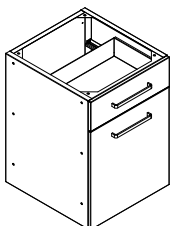
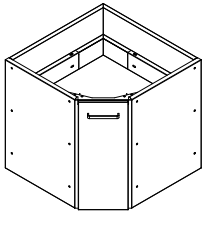
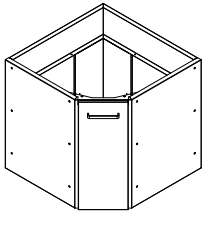
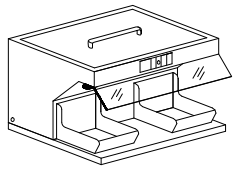
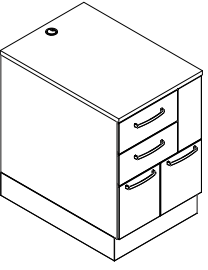
	Descrizione / Description Description / Beschreibung / Descripción	Apertura Opening / Ouverture Öffnung / Apertura	M ³ Kg	Articolo Item / Article Artikel / Artículo	Prezzo Price / Prix Preis / Precio
 <p>Modulare completo di cassetto per spatole, cassetto portarifiuti, 3 cassetti con bacinelle B10M per il gesso, protezione piano in gomma</p> <p>Unit with knife drawer, dustbin, 3 drawers with plaster trays B10M and rubber-surfaced top</p> <p>Module avec tiroir pour spatules, 1 grand tiroir poubelle, 3 tiroirs avec intérieurs B10M pour le plâtre et un protège-plateau en caoutchouc</p> <p>Schrank mit Schublade für Spatel, Abfallkorb, 3 Schubladen mit Einsätzen B10M für Gips, Arbeitsunterlage aus Gummi</p> <p>Módulo con cajón para las espátulas, cubo de basura, 3 cajones con bandejas B10M para el yeso, protección de goma para la encimera</p> <p>L 1000 x P 540 x H 700 mm</p>	<p>Maniglia Handle Poignée Griff Tirador</p>	0,4 80	PR10M	€ 1.571,00	
	<p>Push-Pull</p>	0,4 80	PR10P	€ 1.672,00	
 <p>Modulare completo di 3 cassetti con bacinelle B10M per il gesso, cassetto per spatole, cassetto portarifiuti, protezione piano in gomma</p> <p>Unit with 3 drawers with plaster trays B10M, knife drawer, dustbin and rubber surfaced-top</p> <p>Module avec 3 tiroirs avec intérieurs B10M pour le plâtre, 1 tiroir pour spatules, 1 grand tiroir poubelle et un protège-plateau en caoutchouc</p> <p>Schrank mit 3 Schubladen mit Einsätzen B10M für Gips, Schublade für Spatel, Abfallkorb, Arbeitsunterlage aus Gummi</p> <p>Módulo con 3 cajones con bandejas B10M para el yeso, cajón para las espátulas, cubo de basura, protección de goma para la encimera</p> <p>L 1000 x P 540 x H 700 mm</p>	<p>Maniglia Handle Poignée Griff Tirador</p>	0,4 80	PR11M	€ 1.571,00	
	<p>Push-Pull</p>	0,4 80	PR11P	€ 1.672,00	
 <p>Modulare livello</p> <p>Sink unit</p> <p>Module évier</p> <p>Wasbeckenschrank rechts</p> <p>Modulo lavabo</p> <p>L 1000 x P 540 x H 700 mm</p>	<p>Maniglia Handle Poignée Griff Tirador</p>	0,5 37	PR14M	€ 709,00	
	<p>Push-Pull</p>	0,5 37	PR14P	€ 749,00	
 <p>Modulare livello</p> <p>Sink unit</p> <p>Module évier</p> <p>Wasbeckenschrank rechts</p> <p>Modulo lavabo</p> <p>L 500 x P 540 x H 700 mm</p>		0,2 25	PR20M	€ 484,00	
		0,2 25	PR20P	€ 504,00	

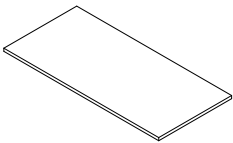
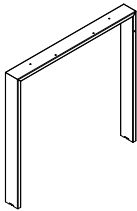
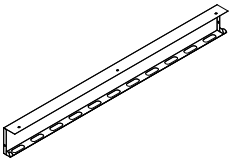
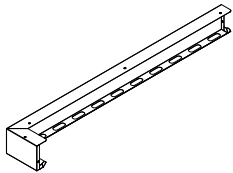
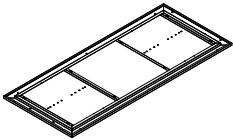
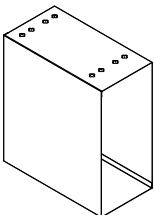
	Descrizione / Description Description / Beschreibung / Descripción	M ³ Kg	Articolo Item / Article Artikel / Artículo	Prezzo Price / Prix Preis / Precio
 <p>Modulare completo di cassetto per le spatole, cassettone portarifiuti e protezione piano in gomma Unit with knife drawer, dustbin and rubber-surfaced top Module complet avec tiroir pour spatules, 1 grand tiroir poubelle et protège-plateau en caoutchouc Schrank mit Schublade für Spatel, Abfallkorb und Arbeitsunterlage aus Gummi Módulo con cajón para las espátulas, cubo de basura y protección de goma para la encimera</p> <p>L 500 x P 540 x H 700 mm</p>		0,2 40	PR22M	€ 898,00
		0,2 40	PR22P	€ 938,00
 <p>Modulare angolare con ripiano interno Corner unit with an interior shelf Module d'angle avec 1 étagère interne Eckschrank mit 1 Einlegeboden Módulo angular con estante interior</p> <p>L 730 x P 730 x H 700 mm</p>		0,4 34	PROAM	€ 677,00
		0,4 34	PROAP	€ 697,00
 <p>Modulare lavello angolare Corner sink unit Module évier d'angle Waschbeckeneckschrank Modulo lavabo angular</p> <p>L 730 x P 730 x H 700 mm</p>		0,4 26	PRALM	€ 626,00
		0,4 26	PRALP	€ 646,00
 <p>Aspirazione da appoggio per pulitrice completa di illuminazione - 3 anni di garanzia Suction unit for polisher, with light - 3 years warranty Aspiration d'appui pour nettoyeuse, complète d'éclairage - 3 ans de garantie Absaugbox für Poliermotor, mit Licht - 3 Jahre Garantie Aspiración de apoyo para pulidora, con iluminación - 3 años de garantía</p> <p>L 700 x P 550 x H 535 mm</p>		0,2 40	AAP	€ 3.616,00
 <p>Modulare per appoggio fresatore con piano in laminato bianco e boccola passacavo con chiusura, 2 cassetti H 230 (con guide ammortizzate) e 1 tamponamento + 2 antine. Completo di basamento H 180 Modular item for router support with white laminate top and cable gland bush with closure, 2 H230 drawers (with cushioned guides) and 1 infill + 2 doors. Complete with H 180 base Modulaire pour appui fraiseuse avec plan en laminé blanc et douille passe-câbles avec fermeture, 2 tiroirs H 230 (avec glissières amorties) et 1 cache de fermeture + 2 portillons. Muni d'un socle H 180 Modular für Fräsenaufsatz mit Auflage aus weißem Laminat und Kabelführungsbuchse mit Verschluss, 2 Schubladen H 230 (mit gefederten Führungen) und 1 Puffer + 2 kleinen Türen. Versehen mit Sockel H 180 Mueble modular para soporte de fresadora con encimera de laminado blanco y casquillo pasacables con cierre, 2 cajones H 230 (con guías amortiguadas) y 1 elemento de relleno + 2 puertas. Con base H 180</p> <p>L 700 x P 1000 x H 1060 mm</p>		- 105	PR23M	€ 1.948,00

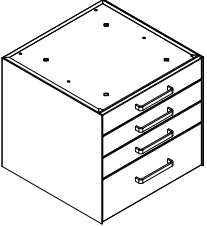
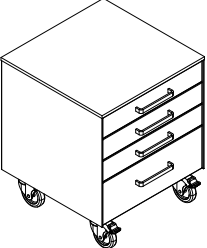
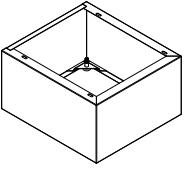
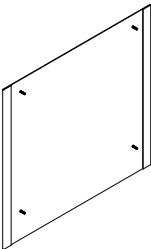
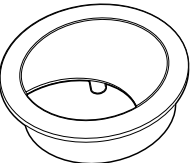
	Descrizione / Description Description / Beschreibung / Descripción	M³ Kg	Articolo Item / Article Artikel / Artículo	Prezzo Price / Prix Preis / Precio
	Piano in laminato grigio bordato PVC: al metro lineare Grey laminate-surfaced. PVC edged top: per meter Plan en laminé gris avec bord en PVC: au mètre Grau Laminatarbeitsplatte mit PVCkante: je Meter Tablero de laminado gris con borde de PVC: al m.	- 11	PWPL	€ 255,00
P 750 x H 20 mm				
	Supporto laterale dx o sx Lateral support Support lateral Seitenwand für Soporte lateral	- 6,5	(SX) PW01	€ 149,00
L 80 x P 750 x H 710 mm			(DX) PW02	€ 149,00
	Schiena posteriore: al metro lineare Rear panel: per meter Panneau arrière: au mètre Rückseite: je Meter Panel posterior: al m.	- 2,5	PW05	€ 52,00
P 70 x H 160 mm				
	Schiena posteriore ad angolo: al metro lineare Profwork rear corner panel Panneau d'angle arrière Profwork Eckrückseite Profwork Panel posterior angular Profwork	- 2,5	PW11	€ 62,00
P 70 x H 160 mm				
	Telaio supporto piano: al metro lineare Frame to support the top: per meter Châssis pour soutenir le plan: au mètre Rahmen für Arbeitsplatte: je Meter Frame para apoyar las encimeras: al m.	- 11,2	PW07	€ 182,00
P 710 x H 20 mm				
	Vano porta PC PC-holder compartment Logement pour unité centrale PC-Fach Compartimiento de la PC	- 7,5	PW03	€ 94,00
L 220 x P 420 x H 468 mm				

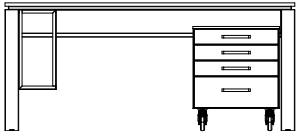
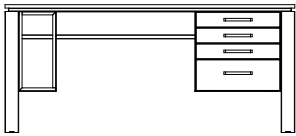
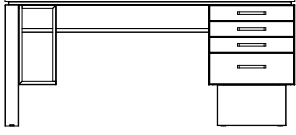
	Descrizione / Description Description / Beschreibung / Descripción	M ³ Kg	Articolo Item / Article Artikel / Artículo	Prezzo Price / Prix Preis / Precio
 <p>Modulare completo di 4 cassetti Unit with 4 drawers Module avec 4 tiroirs Schrank mit 4 Schubladen Módulo con 4 cajones</p> <p>L 506 x P 496 x H 468 mm</p>		0,1 36	PW06M	€ 596,00
		0,1 36	PW06P	€ 697,00
 <p>Modulare completo di 4 cassetti con Kit ruote + Piano stratificato Modular item complete with 4 drawers with wheels kit + Laminated top Modulaire doté de 4 tiroirs avec Kit roulettes + Plan stratifié Modular mit 4 Schubladen mit Räderbausatz + Verbundplatte Mueble modular con 4 cajones y Kit de ruedas + Encimera estratificada</p> <p>L 508 x P 620 x H 500 mm</p>		0,1 45	PW08M	€ 899,00
		0,1 45	PW08P	€ 1.000,00
 <p>Basamento cassettiera PROF Work PROF Work Base unit L.403 Base PROF Work L.403 PROF Work Sockel L.403 Base PROF Work L.403</p> <p>L 403 x P 450 x H 241 mm</p>		- 4,5	PW09	€ 60,00
 <p>Fianco finitura PROF Work PROF Work Lateral side Panneau latéral PROF Work PROF Work Seitenwand Panel lateral PROF Work</p> <p>L 700 x P 595 mm</p>		- -	PW04	€ 57,00
 <p>Boccola passacavo con chiusura - Grigio Alluminio Cable bush with plug - Aluminum Grey Manchon passe-câbles avec fermeture - Gris aluminium Kabeldurchführung mit Verschluss - Aluminiumgrau Casquillo pasacables con cierre - Gris Aluminio</p> <p>Ø 60 mm</p>		- -	BOPM	€ 30,00

	Descrizione / Description Description / Beschreibung / Descripción	M³ Kg	Articolo Item / Article Artikel / Artículo	Prezzo Price / Prix Preis / Precio
	<p>Composizione PROF WORK con fusto cassetti su ruote e porta PC</p> <p>PROF WORK Composition with drawers on wheels and PC holder</p> <p>Composition PROF WORK avec bloc-tiroirs sur roulettes et porte PC</p> <p>Komposition PROF WORK mit Schubladensockel auf Rädern und PC-Tür</p> <p>Composición PROF WORK con cuerpo cajones sobre ruedas y porta PC</p>	- 107	A	€ 2.136,00
<p>L 1700 x P 750 x H 750 mm</p>				
	<p>Composizione PROF WORK con fusto sospeso e porta PC</p> <p>PROF WORK Composition with suspended drawers and PC holder</p> <p>Composition PROF WORK avec bloc suspendu et porte PC</p> <p>Komposition PROF WORK mit Hängesockel und PC-Tür</p> <p>Composición PROF WORK con cuerpo colgante y porta PC</p>	- 105	B	€ 1.946,00
<p>L 1700 x P 750 x H 750 mm</p>				
	<p>Composizione PROF WORK con fusto su basamento e porta PC</p> <p>Profwork composition with unit on base and PC holder</p> <p>Composition Profwork avec module sur socle et porte-PC</p> <p>Profwork-Komposition mit Schrank auf Sockel und PC-Halterung</p> <p>Composición Profwork con módulo sobre base y soporte para PC</p>	- 103	C	€ 1.875,00
<p>L 1700 x P 750 x H 750 mm</p>				
	<p>Composizione semplice con piano e supporti laterali</p> <p>Simple PROF WORK Composition with top and side supports</p> <p>Composition PROF WORK simple avec plan et supports latéraux</p> <p>Einfache Komposition PROF WORK mit Ebene du seitlichen Stützen</p> <p>Composición PROF WORK simple con encimera y soportes laterales</p>	- 55	D	€ 1.143,00
<p>L 1700 x P 750 x H 750 mm</p>				

PROF BOX

Furniture / Modules / Schränke / Modulos

LORAN

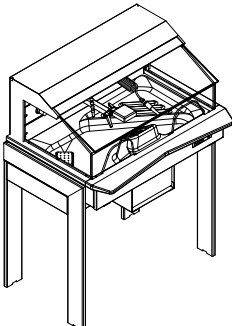
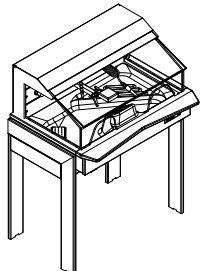
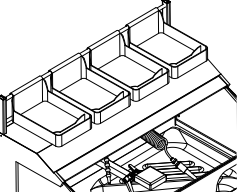
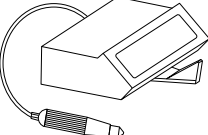
	Descrizione / Description Description / Beschreibung / Descripción	M ³ Kg	Articolo Item / Article Artikel / Artículo	Prezzo Price / Prix Preis / Precio
 <p>PROF BOX completo di aspirazione con motore a spazzola complete with suction with brush motor complet d'aspiration avec moteur à balais komplett mit Absaugung, variable Saugleistung completo de aspiración con el motor del cepillo</p> <p>L 870 x P 670 x H 1170 mm</p>		- 86	+ A1F	PRBOX0A € 4.598,00
 <p>PROF BOX predisposto per aspirazione with predisposition for suction system avec prédisposition pour système d'aspiration bereit zum Anschluss einer Absaugung preajuste para el equipo de aspiración</p> <p>L 870 x P 670 x H 1170</p>		- 79		PRBOX0B € 3.527,00
 <p>Supporto con 4 bacinelle portalavori Support with 4 basins for workpieces Support avec 4 bassinets porte travail Regalschienensystem mit 4 arbeitschalen Soporte con 4 bandejas portatrabajo</p>		- -		SBM+BPL € 149,00
 <p>Micromotore con alimentatore a pedale Micromotor with pedal control Micromoteur complet avec alimentation à pédale Mikromotor mit Pedalbedienung Micromotor con alimentador de pedal</p>		- 3,5		MM € 1.113,00

VELA

LOOK

LIKE

ALA / QUADRO
NOVO / UPRIGHT

MOVINGTRAY
MOVING ARM

PURAS
PURASTUDIO

STERIL K

CART

ARMADI

BACINELLE

PIANI
ALZATINE

LAVELLI
RUBINETTI

LAVORAZIONI
ACCESSORI



OPEN BOX
SEGGIOLINI

PROF

MAESTRO

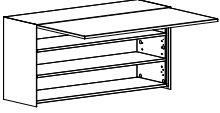
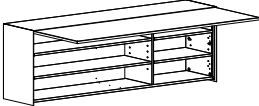
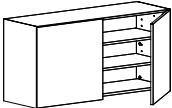
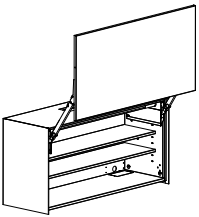
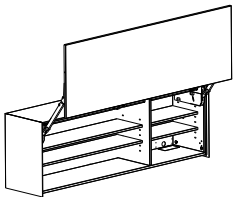
IMPIANTISTICA

	Descrizione / Description Description / Beschreibung / Descripción	Fianchi Sides / Côtés Seiten / Laterales	M ³ Kg	Articolo Item / Article Artikel/Artículo	Prezzo Price / Prix Preis / Precio
 <p>L 1006 x P 350 x H 500 mm</p>	<p>PENSILE L 1006 mm con anta a ribalta verniciata o in vetro, con 2 ripiani interni</p> <p>Wall unit L 1006 mm with flap painted or glass door, with 2 inner shelves</p> <p>Élément haut L 1006 mm avec porte battante peinte ou en verre, avec 2 étagères intérieures</p> <p>Hängeschrank L 1006 mm mit lackierter Kipptür oder Glastür und 2 Inneneinlegeböden</p> <p>Mueble colgante L 1006 mm con hoja basculante pintada o de vidrio, con 2 estantes internos</p>	<p>Anta verniciata Painted / Verni Lackiert Pintado</p>	<p>0,16 34,5</p>	PVOA	€ 939,00
		<p>Anta in vetro Glass / Verre Glas / Vidrio</p>	<p>0,16 34,5</p>	PVOAV	€ 1.210,00
 <p>L 1506 x P 350 x H 500 mm</p>	<p>PENSILE L 1506 mm con anta a ribalta verniciata o in vetro, con 2+2 ripiani interni e divisorio verticale</p> <p>Wall unit L 1506 mm with flap painted or glass door, with 2+2 inner shelves and vertical partition</p> <p>Élément haut L 1506 mm avec porte battante peinte ou en verre, avec 2+2 étagères intérieures et séparation verticale</p> <p>Hängeschrank L 1506 mm mit lackierter Kipptür oder Glastür, 2+2 Inneneinlegeböden und senkrechtem Trennelement</p> <p>Mueble colgante L 1506 mm con hoja basculante pintada o de vidrio, con 2+2 estantes internos y separador vertical</p>	<p>Anta verniciata Painted / Verni Lackiert Pintado</p>	<p>0,25 63,5</p>	PVOB	€ 1.228,00
		<p>Anta in vetro Glass / Verre Glas / Vidrio</p>	<p>0,25 63,5</p>	PVOBV	€ 1.594,00
 <p>L 1006 x P 350 x H 500 mm</p>	<p>PENSILE L 1006 mm con 2 ante battenti e 2 ripiani interni</p> <p>Cupboard L 1006 mm with 2 doors and 2 internal shelves</p> <p>Élément mural L 1006 mm avec 2 portes battantes et 2 étagères intérieures</p> <p>Hängeschrank L 1006 mm mit 2 Türflügeln und 2 Inneneinlegeböden</p> <p>Mueble colgante L 1006 mm con 2 hojas batientes y 2 estantes interiores</p>	<p>Verniciato Painted / Verni Lackiert Pintado</p>	<p>0,25 34</p>	PVOC	€ 788,00
		<p>Anta verniciata Painted / Verni Lackiert Pintado</p>	<p>0,25 52</p>	PVOG	€ 1.135,00
 <p>L 1006 x P 350 x H 500 mm</p>	<p>PENSILE L 1006 mm con anta apertura verticale verniciata, con 2 ripiani interni</p> <p>Wall unit L 1006 mm with painted vertical opening door, with 2 internal shelves</p> <p>Élément haut L 1006 mm avec porte ouverture vertical peinte, avec 2 étagères intérieures</p> <p>Hängeschrank L 1006 mm mit lackierter vertikaler Tür, mit 2 Innenregalen</p> <p>Mueble colgante L 1006 mm con puerta de apertura vertical pintada, con 2 estantes interiores</p>	<p>Anta verniciata Painted / Verni Lackiert Pintado</p>	<p>0,25 52</p>	PVOG	€ 1.135,00
		<p>Anta verniciata Painted / Verni Lackiert Pintado</p>	<p>0,25 70</p>	PVOI	€ 1.481,00
 <p>L 1506 x P 350 x H 500 mm</p>	<p>PENSILE L 1506 mm con anta apertura verticale verniciata, con 2+2 ripiani interni e divisorio verticale</p> <p>Wall unit L 1506 mm with painted vertical opening door, with 2+2 inner shelves and vertical partition</p> <p>Élément haut L 1506 mm avec porte ouverture vertical peinte, avec 2+2 étagères intérieures et séparation verticale</p> <p>Hängeschrank L 1506 mm mit lackierter vertikaler Tür, 2+2 Inneneinlegeböden und senkrechtem Trennelement</p> <p>Mueble colgante L 1506 mm con puerta de apertura vertical pintada, con 2+2 estantes internos y separador vertical</p>	<p>Anta verniciata Painted / Verni Lackiert Pintado</p>	<p>0,25 70</p>	PVOI	€ 1.481,00
		<p>Anta verniciata Painted / Verni Lackiert Pintado</p>	<p>0,25 70</p>	PVOI	€ 1.481,00

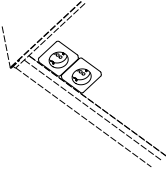
	Descrizione / Description Description / Beschreibung / Descripción	M³ Kg	Articolo Item / Article Artikel/Artículo	Prezzo Price / Prix Preis / Precio
	<p>LAMPADA A LED sottopensile/sottomensola con interruttore touch</p> <p>Under-floor/-shelf LED lamp with touch switch</p> <p>Lampe à LED sous élément haut/sous étagère avec interrupteur tactile</p> <p>LED-lampe für Unterbau Hängeschrank/Regal mit Touch-Schalter</p> <p>Lámpara de LED debajo del mueble colgante/estante con interruptor táctil</p>	-	PLEDE10	<p>€ 201,00</p>
		-	Fino a / Up to L = 1000 mm	
	<p>LAMPADA A LED interna al pensile</p> <p>LED lamp inside the wall unit</p> <p>Lampe à LED à l'intérieur de l'élément haut</p> <p>LED-lampe Hängeschrankinnenseite</p> <p>Lámpara de LED incorporada dentro del mueble colgante</p>	-	PLEDI10	<p>€ 261,00</p>
		-	Fino a / Up to L = 1000 mm	
	<p>Coppia di prese di corrente schuko sotto al pensile</p> <p>Pair of Schuko power outlets under the wall unit</p> <p>Deux prises de courant Schuko sous l'élément haut</p> <p>1 Paar Schuko-Stromsteckdosen unter Hängeschrank</p> <p>Par de tomas de corriente schuko debajo del mueble colgante</p>	-	PAP04	<p>€ 73,00</p>
		-	L = da / from 1000 mm a / to 1500 mm	

PROF | Supporti per mobili serie "S"

Supports for units range "S" / Support pour modules série "S"

Gestellen für Schränke Linie "S" / Soporte par módulos modelo "S"

LORAN

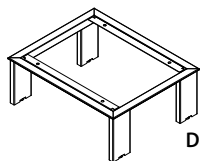
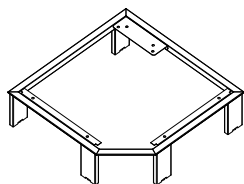

Da L. 500 a L. 1000

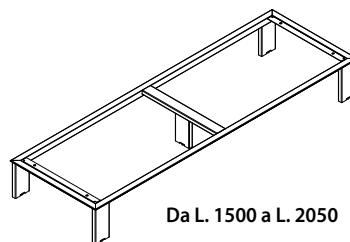

Da L. 1500 a L. 2050

	Descrizione / Description Description / Beschreibung / Descripción	M³ Kg	Articolo Item / Article Artikel / Artículo	Prezzo Price / Prix Preis / Precio
L 662 x P 662 x H 180 mm	<p>Supporto angolare con piedini Corner support with feet Support d'angle avec pieds Eckgestell mit Füßen Soporte angular con patas</p>	0,09 8,5	PRSOA	€ 173,00
L 500 x P 488 x H 180 mm	<p>Supporto con piedini L.500 Support with feet L.500 Support avec pieds L.500 Gestell mit Füßen L.500 Soporte con patas L.500</p>	0,04 6,5	PRS05	€ 137,00
L 1000 x P 488 x H 180 mm	<p>Supporto con piedini L.1000 Support with feet L.1000 Support avec pieds L.1000 Gestell mit Füßen L.1000 Soporte con patas L.1000</p>	0,09 8,5	PRS10	€ 160,00
L 1500 x P 488 x H 180 mm	<p>Supporto con piedini L.1500 Support with feet L.1500 Support avec pieds L.1500 Gestell mit Füßen L.1500 Soporte con patas L.1500</p>	0,13 12	PRS15	€ 227,00
L 2000 x P 488 x H 180 mm	<p>Supporto con piedini L.2000 Support with feet L.2000 Support avec pieds L.2000 Gestell mit Füßen L.2000 Soporte con patas L.2000</p>	0,17 15,5	PRS20	€ 297,00

PROF | Basamenti per mobili serie "B"

Base for units range "B" / Bases pour modules série "B"

Sockel für Schränke Linie "B" / Bases par módulos modelo "B"

LORAN

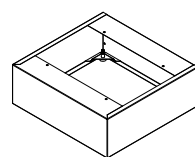
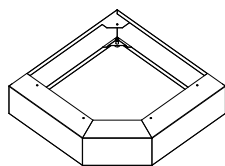

Da L. 500 a L. 1000

	Descrizione / Description Description / Beschreibung / Descripción	M³ Kg	Articolo Item / Article Artikel / Artículo	Prezzo Price / Prix Preis / Precio
Basamento angolare Corner base unit Base d'angle Ecksocket Base Angular	L 702 x P 702 x H 180 mm	0,09 6	PRBOA	€ 68,00
Basamento L.500 Base unit L.500 Base L.500 Sockel L.500 Base L.500	L 500 x P 478 x H 180 mm	0,04 4,5	PRB05	€ 61,00
Basamento L.1000 Base unit L.1000 Base L.1000 Sockel L.1000 Base L.1000	L 1000 x P 478 x H 180 mm	0,09 6,5	PRB10	€ 71,00

PROF | Fianchi Sides / Côtés / Seiten / Laterales

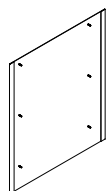

L 700 x P 595 mm

Fianco laterale

Lateral side
Panneau latéral
Seitenwand
Panel lateral

-
6

PRFM60

€ **84,00**

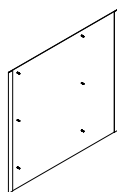

L 700 x P 635 mm



Fianco laterale

Lateral side
Panneau latéral
Seitenwand
Panel lateral

-
6,4

PRFM64

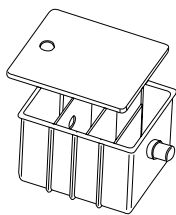
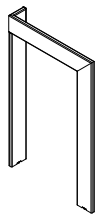
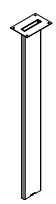

€ **84,00**

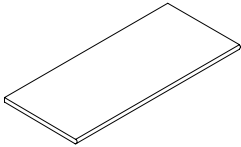
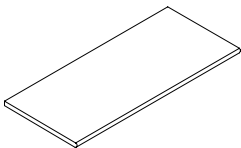
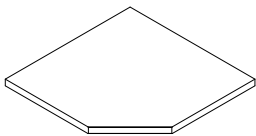
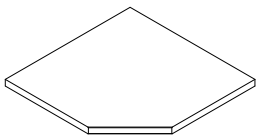

	Descrizione / Description Description / Beschreibung / Descripción	M³ Kg	Articolo Item / Article Artikel / Artículo	Prezzo Price / Prix Preis / Precio
	<p>Decantatore cilindrico con sacchetto per il recupero del materiale decantato</p> <p>Cylinder-shaped decanter, with collection bag Décanteur cylindrique avec sachet pour la récupération du matériel décanté Zylinderförmiger Gipsabscheider mit Beutel zum Auffangen des abgetrennten Materials Decantador cilíndrico con saco para la recuperación del material decantado</p>	- 2,5	DEB	€ 565,00
L ø 340 x P ---- x H 300 mm				
	<p>Confezione con n° 25 sacchetti per decantatore DEB</p> <p>Pack of 25 sacks for decanter DEB Confection de n° 25 sachets pour décanteur DEB N. 25 Müllsacks für Gipsabscheider DEB Paquete con 25 sacos para el decantador DEB</p>	- 1	SAD	€ 38,00
	<p>Decantatore in ABS</p> <p>ABS decanter Bac de decantation en ABS Gipsabscheider aus ABS Decantador en ABS</p>	- 2,6	DEP	€ 443,00
L 320 x P 430 x H 270 mm				
	<p>Supporto laterale mobili</p> <p>Lateral support for units Support lateral pour modules Seitenwand für Schränke Soporte lateral para módulos</p>	- 8	PRLM	€ 179,00
L 100 x P 560 x H 880 mm				
	<p>Supporto di sostegno in tubolare singolo per piano</p> <p>Single tube shelf bracket Support en tube simple pour plan de travail Stützvorrichtung aus einfachem Rohr für Arbeitsplatte Soporte de sostén en tubular para la encimera</p>	- 4	PRLT	€ 148,00
L 20 x P 100 x H 880 mm				

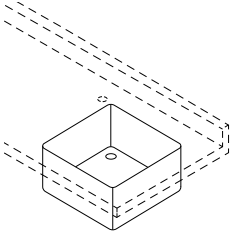
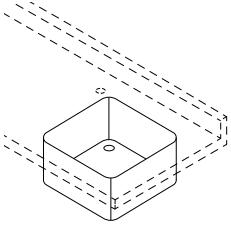
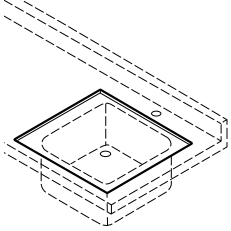
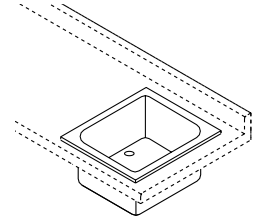
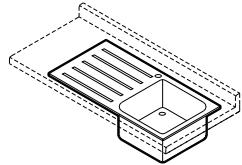

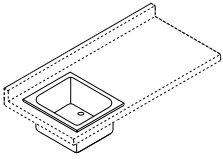
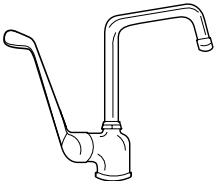
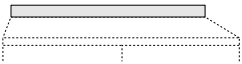
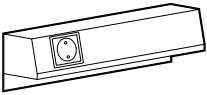
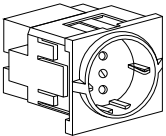

	Descrizione / Description Description / Beschreibung / Descripción	M³ Kg	Articolo Item / Article Artikel / Artículo	Prezzo Price / Prix Preis / Precio
	<p>Piano in laminato grigio bordato PVC al metro lineare</p> <p>Grey laminate-surfaced. PVC edged top: per meter Plan en laminé gris avec bord en PVC: au mètre Grau Laminatarbeitsplatte mit PVCkante: je Meter Tablero de laminado gris con borde de PVC: al m.</p>	- 12	PRPM	€ 200,00
L a misura x P 600 x H 20 mm				
	<p>Piano in acciaio inox al metro lineare</p> <p>Stainless steel top: per meter Dessus en acier inox: au mètre Edelstahlarbeitsplatte: je meter Tablero de acero inoxidable: al m.</p>	- 21	AD	€ 681,00
L a misura x P 600 x H 20 mm				
	<p>Piano angolare in laminato</p> <p>Laminate top for corner units Plan en laminé pour modules d'angles Weiße Laminatarbeitsplatte für Eckschränke Encimera de laminado para módulos angulares</p>	- -	PRPA	€ 323,00
L 791 x P 791 x H 20 mm				
	<p>Piano angolare in acciaio inox</p> <p>Stainless steel corner top Plan angulaire en acier inox Eckplatte aus Edelstahl Encimera angular de acero inoxidable</p>	- -	ADAM	€ 1.180,00
L 791 x P 791 x H 20 mm				

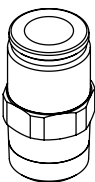
	Descrizione / Description Description / Beschreibung / Descripción	M³ Kg	Articolo Item / Article Artikel / Artículo	Prezzo Price / Prix Preis / Precio
	Foro gesso su piano laminato inox Hole for plaster waste on laminate / stainless steel Trou plâtre sur plan laminé / inox Gipsloch auf laminiertes Platte auf Edelstahlplatte Agujero escayola en encimera laminada acero inoxidable	-	FGL	€ 68,00
		-	laminato	
		-	FGI	€ 331,00
		-	inox	
	Taglio obliquo su piano laminato Oblique cut of laminate-surfaced top Découpe oblique sur le plan de travail en laminé Schrägschnitt der Laminatarbeitsplatte Corte oblicuo sobre la encimera de laminado	-	TSP	€ 95,00
		-		
	Taglio obliquo su piano inox Oblique cut of stainless steel top Découpe oblique sur le plan de travail en acier inox Schrägschnitt der Edelstahl-arbeitsplatte Corte oblicuo sobre la encimera de acero inoxidable	-	TSI	€ 361,00
		-		
	Set collegamento 2 piani laminato inox Work-top connection set for laminate stainless steel top Set pour la liaison de 2 plans de travail en laminé acier inox Set für Zusammenbau von Laminatarbeitsplatten Edelstahl-arbeitsplatte Juego para la unión de las 2 encimeras de laminado acero inoxidable	-	SCP	€ 60,00
		-	laminato	
		-	SCI	€ 165,00
		-	inox	

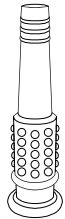
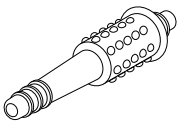
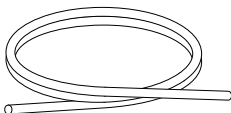
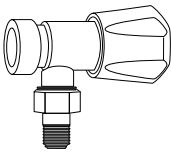
	Descrizione / Description Description / Beschreibung / Descripción	M³ Kg	Articolo Item / Article Artikel / Artículo	Prezzo Price / Prix Preis / Precio
 <p>Lavello in acciaio inox con angoli interni di raggio 10 mm incorporato al piano inox Stainless steel sink with 10 mm radius internal corners incorporated into the stainless steel top Évier en acier inox avec angles internes de 10 mm de rayon incorporé au plan en inox Waschbecken aus Edelstahl mit Innenecken (10 mm Radius), eingebaut in die Edelstahlplatte Lavabo de acero inoxidable con esquinas internas, radio 10 mm, incorporado en la encimera de acero inoxidable</p> <p>L 400 x P 400 x H 200 mm</p>	-	5	V1P	€ 883,00
 <p>Lavello in acciaio inox con angoli interni di raggio 30 mm incorporato al piano inox Stainless steel sink with 30 mm radius internal corners incorporated into the stainless steel top Évier en acier inox avec angles internes de 30 mm de rayon incorporé au plan en inox Waschbecken aus Edelstahl mit Innenecken (30 mm Radius), eingebaut in die Edelstahlplatte Lavabo de acero inoxidable con esquinas internas, radio 30 mm, incorporado en la encimera de acero inoxidable</p> <p>L 400 x P 340 x H 200 mm</p>	-	5	V1I	€ 594,00
 <p>Abbassamento per lavello in acciaio inox incorporato al piano, al metro lineare Lowered element for stainless steel sink incorporated into the top, per meter Abaissement pour évier en acier incorporé au plan, au mètre Vertiefung für in die Ebene eingebautes Edelstahl-Waschbecken, je Meter Bajada para lavabo de acero inoxidable incorporado en la encimera, al m.</p>	-	-	VAA	€ 213,00
 <p>Lavello rettangolare in acciaio inox soprapiano Top mounted stainless steel sink Évier en inox sur plan Aufgesetztes Edelstahlwaschbecken Lavabo de acero sobre encimera</p> <p>L 360 x P 360 x H 163 mm</p>	-	2,5	V2S	€ 335,00
 <p>Lavello in acciaio inox e sgocciolatoio da incasso Stainless steel sink with draining board Évier en inox avec égouttoir Edelstahlwaschbecken mit Abtropfblech Lavabo de acero con escurridor</p> <p>L 860 x P 500 x H 170 mm</p>	-	3,5	V3S	€ 349,00

	Descrizione / Description Description / Beschreibung / Descripción	M³ Kg	Articolo Item / Article Artikel / Artículo	Prezzo Price / Prix Preis / Precio
	Inserto inox con lavello Stainless steel insert with sink Insert inox avec évier Edelstahleinsatz mit Spüle und Abtropfblech Elemento de Acero inoxidable con lavabo	- 2,5	V2S	€ 335,00
L 360 x P 360 x H 163				
	Rubinetto cromato con collo alto Chromed mixer Mitigeur chromé Verchromte Wasserhahn Grifo cromado	- 1,5	RB4	€ 183,00
	Alzatina inox applicata: al metro lineare Applied stainless steel reartrim: per meter Dossieret appliqué en inox: au mètre Edelstahlaufgeklebter Aufkantung: je meter Elevación aplicado de acero: al m.	- 1,3	AIM	€ 46,00
L a misura x P 15 x H 60 mm	Minimo fatturabile: 1 metro lineare Minimum charge: 1 meter Base minimale de facturation: 1 mètre Mindestgebühr: 1 meter Mínimo facturable: 1 metro			
	Canalina tecnica in alluminio anodizzato al metro lineare Aluminium raceway: per meter Canalisation technique en aluminium: je meter Technikkanal aus eloxiertem Aluminium: je Meter Canal técnico de aluminio: al m.	- 1,2	CVE	€ 93,00
L a misura x P 63 x H 75 mm				
	Presa di corrente Schuko montata su canalina tecnica CVE Schuko socket fitted on raceway CVE Prise de courant Schuko montée sur canalisation technique CVE Schuko-Steckdose für Technikkanal CVE Toma de corriente Schuko para canal técnico CVE	- -	PCS	€ 37,00
	Colonna con 3 prese Schuko a scomparsa sul piano Column with 3 Schuko sockets concealable in the worktop Colonne avec 3 prises de courant Schuko escamotables dans le plan de travail Säule mit 3 Schuko-Steckdosen, voll in die Ebene integrierbar Columna con 3 tomas Schuko ocultas en la encimera	- 0,6	CPC	€ 448,00
	Colonna con 3 prese Schuko e 2 prese dati a scomparsa sul piano Column with 2 Schuko sockets and 2 data sockets concealable in the worktop Colonne avec 2 prises de courant Schuko et 2 prises données escamotables dans le plan Säule mit 2 Schuko-Steckdosen und 2 Daten-Buchsen voll in die Ebene integrierbar Columna con 2 tomas Schuko y 2 tomas de datos ocultas en la encimera	- 0,6	CPD	€ 579,00

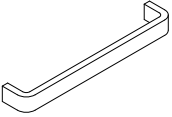
	Descrizione / Description Description / Beschreibung / Descripción	M³ Kg	Articolo Item / Article Artikel / Artículo	Prezzo Price / Prix Preis / Precio
	Attacco rapido aria montato su canalina tecnica CVE Quick air connection fitted on raceway CVE Raccord rapide air monté sur canalisation technique CVE Druckluftanschluß mit Schnellkupplung für Technikkanal CVE Conexión rápida de aire montada sobre el canal técnico CVE	- ---	ARA	€ 69,00
	Riduttore di pressione montato su canalina tecnica CVE Pressure reducer fitted on raceway CVE Réducteur de pression pour l'air, monté sur canalisation technique CVE Druckreduzierer integriert im Technikkanal CVE Reductor de presión montado sobre el canal técnico CVE	- ---	RIP	€ 96,00
	Manometro montato su canalina tecnica CVE Pressure gauge fitted on raceway CVE Manomètre monté sur canalisation technique CVE Druckmanometer für Technikkanal CVE Manómetro montado sobre el canal técnico CVE	- ---	MAN	€ 90,00
	Siringa aria per modulari di servizio, a scomparsa sul piano Hide-away top air syringe for service units Soufflette air pour modules de travail, escamotable sur le plan Versenkbare Luftspritze auf der Arbeitsplatte Jeringa de aire para módulos de servicio escamoteable sobre la encimera	- ---	SAR	€ 103,00
	Siringa aria solo manipolo Air syringe, only holder Soufflette à air, seule pièce à main Luftspritze, nur Handstück Jeringa de aire, solo mando	- ---	PIS04	€ 23,00
	Tubo calzato nero per siringa aria: al metro Black hose for air syringe: price per meter Tuyau revêtu noir pour soufflette à air : au mètre Schwarzer ummantelter Schlauch für Luftspritze: pro Meter Tubo encastrado negro para jeringa de aire, por metro	- ---	TU003	€ 32,00
	Rubinetto per squadramodelli Mixer for trimmer-rack Robinet pour la taille-plâtre Hahn für Trimmer Grifo para el instrumento para el recorte de los moldes de yeso	- ---	RUS	€ 53,00

	Descrizione / Description Description / Beschreibung / Descripción	M³ Kg	Articolo Item / Article Artikel / Artículo	Prezzo Price / Prix Preis / Precio	
	<p>Pannello di chiusura da 70 a 150 mm Closing panel from 70 to 150 mm Cache de fermeture de 70 à 150 mm Verschlußverkleidung von 70 bis 150 mm Panel de cierre desde 70 hasta 150 mm</p>	- ----- -	PRPC1	€ 43,00	
H min 700 mm H max 870 mm					
	<p>Pannello di chiusura da 160 a 250 mm Closing panel from 160 to 250 mm Cache de fermeture de 160 à 250 mm Verschlußverkleidung von 160 bis 250 mm Panel de cierre desde 160 hasta 250 mm</p>	- ----- -	PRPC2	€ 58,00	
H min 700 mm H max 870 mm					
	<p>Pannello di chiusura da 160 a 250 mm Corner closing panel Cache de fermeture pour angle Eckverschlußverkleidung Panel de cierre en ángulo</p>	- ----- -	PRPC3	€ 73,00	
H min 700 mm H max 870 mm					
	<p>Maniglia Prof anodizzata Prof anodized aluminum handle Poignée Prof en aluminium anodisé Griff Prof aus eloxiertem Aluminium Tirador Prof aluminio anodizado</p>	<p>Interasse / Wheelbase Entraxe / Abstand Distancia entre ejes 160</p> <p>Interasse / Wheelbase Entraxe / Abstand Distancia entre ejes 224</p>	- ----- - ----- -	MA017 MA018	€ 18,00 € 18,00
	<p>Confezione con n° 50 sacchi gesso Pack of 50 plaster sacks Confection de n° 50 sacs pour le plâtre Gipssacks (50 Stck.) Paquete con 50 sacos de yeso</p>	- ----- -	SAG	€ 100,00	
	<p>Sacco filtro in tessuto per AAP Tissue bag for AAP Sac en tissu pour AAP Stoffsack für AAP Saco de tejido para AAP</p>	- ----- -	SFP	€ 82,00	

PROF | Cappe

Suction hoods / Hottes aspirantes / Einsätze / Bandejas

LORAN

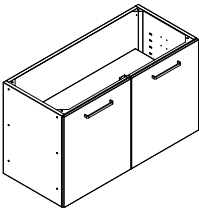
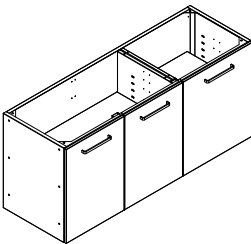
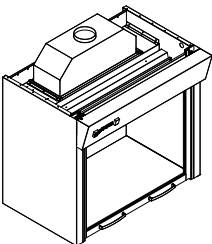
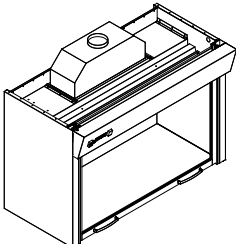
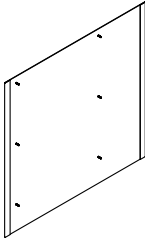
	Descrizione / Description Description / Beschreibung / Descripción	M ³ Kg	Articolo Item / Article Artikel / Artículo	Prezzo Price / Prix Preis / Precio
 <p>Base sottocappa senza piano Hood base (without stainless steel top) Partie basse pour hotte (sans plan de travail inox) Basis für Ofenschrank (ohne Edelstahlarbeitsplatte) Elemento debajo de la campana (sin encimera de acero inoxidable)</p> <p>L 1200 x P 540 x H 700 mm</p>		0,6 55	PRBC120M	€ 945,00
		0,6 55	PRBC120P	€ 986,00
 <p>Base sottocappa senza piano Suction hood (Upper part, working top not included) Hotte aspirante (Partie supérieure, plan de travail pas inclus) Ofenschrank (Oberkörper, kein Arbeitsplatte) Campana aspirante (Parte superior, encimera no incluida)</p> <p>L 1600 x P 540 x H 700 mm</p>		0,9 75	PRBC160M	€ 998,00
		0,9 75	PRBC160P	€ 1.058,00
 <p>Sopracappa senza piano Suction hood (Upper part, working top not included) Hotte aspirante (Partie supérieure, plan de travail pas inclus) Ofenschrank (Oberkörper, kein Arbeitsplatte) Campana aspirante (Parte superior, encimera no incluida)</p> <p>L 1200 x P 740/840 x H 1240 mm</p>		2,0 80	PRSC120	€ 3.531,00
		2,6 100	PRSC160	€ 4.139,00
 <p>Sopracappa senza piano Suction hood (Upper part, working top not included) Hotte aspirante (Partie supérieure, plan de travail pas inclus) Ofenschrank (Oberkörper, kein Arbeitsplatte) Campana aspirante (Parte superior, encimera no incluida)</p> <p>L 1600 x P 740/840 x H 1240 mm</p>		2,6 100	PRSC160	€ 4.139,00
		- 7	PRFC74	€ 131,00
 <p>Fianco laterale cappa Lateral side Panneau latéral Seitenwand Panel lateral</p> <p>P 735 x H 700 mm</p>		- 7	PRFC74	€ 131,00

VELA

LOOK

LIKE

ALA/QUADRO
NOVO/UPRIGHTMOVINGTRAY
MOVING ARMPURA
PURASTUDIO

STERIL K

CART

ARMADI

BACINELLE

PIANI
ALZATINELAVELLI
RUBINETTILAVORAZIONI
ACCESSORIOPEN BOX
SEGGIOLINI

PROF

MAESTRO

IMPIANTISTICA

PROF | Piani per cappe

Tops / Plans / Arbeitsplatten / Encimeras

LORAN

	Descrizione / Description Description / Beschreibung / Descripción	M ³ Kg	Articolo Item / Article Artikel / Artículo	Prezzo Price / Prix Preis / Precio
	Piano inox cappa Stainless steel top Plan en acier inox Edelstahlarbeitsplatte Encimera de acero inox	- 20	PRPC120	€ 1.028,00
L 1210 x P 740 x H 20 mm				

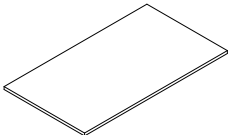
	Piano inox cappa Stainless steel top Plan en acier inox Edelstahlarbeitsplatte Encimera de acero inox	- 26	PRPC160	€ 1.277,00
L 1610 x P 740 x H 20 mm				

Supporti per cappe Floor supports / Supports au sol / Bodengestelle / Soportes de pie

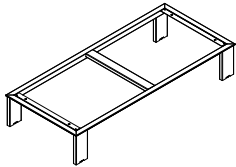
	Supporto con piedini L.1200 Support with feet L.1200 Support avec pieds L.1200 Gestell mit Füßen L.1200 Soporte con patas L.1200	0,10 10	PRS12	€ 174,00
L 1200 x P 488 x H 180 mm				

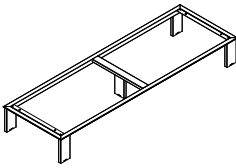
	Supporto con piedini L.1600 Support with feet L.2000 Support avec pieds L.2000 Gestell mit Füßen L.2000 Soporte con patas L.2000	0,17 11,5	PRS16	€ 287,00
L 1600 x P 488 x H 180 mm				

Basamenti per cappe Base units / Bases / Sockel / Bases

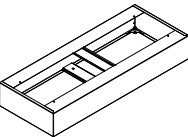
	Basamento L.1200 Base unit L.1200 Base L.1200 Sockel L.1200 Base L.1200	0,10 8,5	PRB12	€ 73,00
L 1200 x P 478 x H 180 mm				

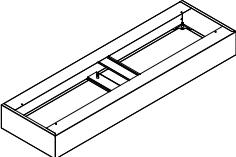
	Basamento L.1600 Base unit L.1600 Base L.1600 Sockel L.1600 Base L.1600	0,14 10,5	PRB16	€ 87,00
L 1600 x P 478 x H 180 mm				

PROF | Cappe pensili

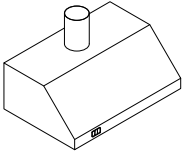
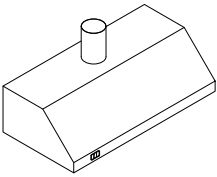

Suspended hoods / Hottes muraux
Wand-Ofenschränke / Campanas colgantes

LORAN

	Descrizione / Description Description / Beschreibung / Descripción	M³ Kg	Articolo Item / Article Artikel / Artículo	Prezzo Price / Prix Preis / Precio
	<p>Cappa aspirante pensile inox con filtri in acciaio inox Stainless steel suspended suction hood with a steel filter Hotte aspirante murale inox avec filtre en acier inox Wandabzugshaube aus Edelstahl mit Edelstahlfilter Campana aspirante colgante de acero inoxidable con filtro de acero</p>	0,4 54	CAP120	€ 3.513,00
L 1200 x P 800 x H 450 mm				
	<p>Cappa aspirante pensile inox con filtri in acciaio inox Stainless steel suspended suction hood with a steel filter Hotte aspirante murale inox avec filtre en acier inox Wandabzugshaube aus Edelstahl mit Edelstahlfilter Campana aspirante colgante de acero inoxidable con filtro de acero</p>	0,6 71	CAP160	€ 3.952,00
L 1600 x P 800 x H 450 mm				

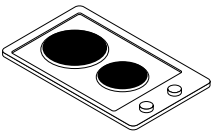
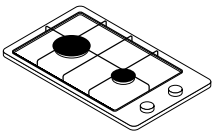
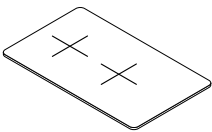
Accessori per cappe Hoods's accessories / Accessoires pour hottes / Zubehörteile für Ofenschränke / Accesorios para campanas

	Descrizione / Description Description / Beschreibung / Descripción	M³ Kg	Articolo Item / Article Artikel / Artículo	Prezzo Price / Prix Preis / Precio
	<p>Inserto coppia piastre elettriche Pair of hot plates Insert avec deux plaques chauffantes Einsatz für zwei Kochplatten Insertable par de placas eléctricas con protección térmica</p>	- 5,5	I2E	€ 496,00
L 300 x P 500 x H 140 mm				
	<p>Inserto coppia fornelli a gas con accensione automatica e valvola di sicurezza Unit with 2 gas stoves with automatic ignition and safety valve Insert avec paire de fourneaux à gaz à allumage automatique et vanne de sûreté Element mit 2 Gaskochern, Sicherheitsventil und automatischem Anzünder Elemento con un par de hornillos de gas con encendido automático y válvula de seguridad</p>	- 5,5	I2G	€ 532,00
L 300 x P 500 x H 140 mm				
	<p>Inserto coppia fornelli a induzione con comandi Touch Control Pair of induction stoves with Touch Control Insert avec deux fourneaux à induction avec commandes Touch Control Einsatz für zwei Induktionkocher mit Touch-Control Insertable par de hornillas de inducción con control táctil</p>	- 5,5	I2I	€ 1.051,00
L 300 x P 500 x H 140 mm				

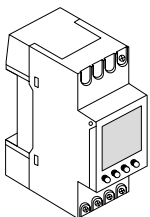
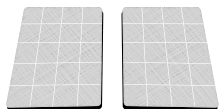
	Descrizione / Description Description / Beschreibung / Descripción	M³ Kg	Articolo Item / Article Artikel / Artículo	Prezzo Price / Prix Preis / Precio
	<p>Mensola porta forno in acciaio inox con supporti</p> <p>Stainless steel oven support Etagère porte-four en inox, complète de supports Edelstahlablage für Muffeln und Lötgut Repisa portahorno de acero inoxidable con soportes</p>	- 12	MPF	€ 799,00
L 800 x P 500 x H 20 mm				
	<p>Pres a e spina di corrente supplementare</p> <p>Additional socket and plug Prise femelle + prise mâle supplémentaires de courant Zusätzliche Steckdose im Ofenschrank Toma y enchufe de corriente adicional</p>	- -	PSC	€ 90,00
	<p>Temporizzatore digitale per accensione aspirazione cappa</p> <p>Digital timer for turning on the suction hood Programmeur pour la mise en marche de l'aspiration de la hotte Digitale Zeitschaltuhr zum Einschalten der Dunstabzugshaube Temporizador digital para el encendido de la aspiración de la campana</p>	- -	TDA	€ 357,00
	<p>Coppia filtri con carboni attivi per cappa</p> <p>Pair of activated carbon filters for hood Deux filtres à charbons actifs pour hotte Zwei Aktivkohlefiltern für Ofenschrank Par de filtros de carbones activos para campanas</p>	- -	FCA	€ 60,00

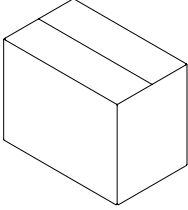
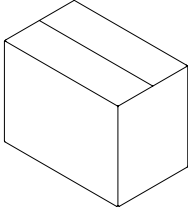
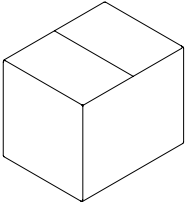
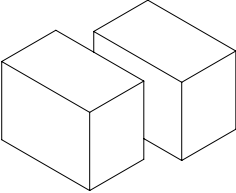
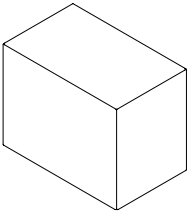
	Descrizione / Description Description / Beschreibung / Descripción	Articolo Item / Article Artikel / Artículo	Prezzo Price / Prix Preis / Precio
	<p>Imballo 1 banco PRF1 o PRF2 (prezzo netto)</p> <p>Package for 1 table (net price) Emballage pour 1 etabli (prix net) Verpackung für 1 Tisch (nettopreis) Embalaje para 1 banco (precio neto)</p>	IM1	€ 80,00
	<p>Imballo 1 banco PRF2-CO o PRFSD (prezzo netto)</p> <p>Package for 1 table (net price) Emballage pour 1 etabli (prix net) Verpackung für 1 Tisch (nettopreis) Embalaje para 1 banco (precio neto)</p>	IM2	€ 115,00
	<p>Imballo 1 modulare e/o altri colli (prezzo netto)</p> <p>Package for 1 unit, other items (net price) Emballage pour 1 module, autres colis (prix net) Verpackung für 1 Schrank, anderes Material (nettopreis) Embalaje módulo, otro material (precio neto)</p>	IM3	€ 55,00
	<p>Imballo 1 cappa (prezzo netto)</p> <p>Boxes for 1 hood (net price) Emballage pour 1 hotte (prix net) Verpackung für 1 Ofenschrank (nettopreis) Embalaje para 1 campana (precio neto)</p>	IM4	€ 170,00
	<p>Spese imballo Prof Box (prezzo netto)</p> <p>Packing costs Prof Box (net price) Frais d'emballage Prof Box (prix net) Verpackungskosten Prof Box (nettopreis) Embalaje Prof Box (precio neto)</p>	IM5	€ 80,00

BANCHI

Tutti i banchi hanno le seguenti dotazioni di serie:

- impianto elettrico
- predisposizione per impianto di aspirazione
- impianto aria compressa completo di siringa, manometro e riduttore di pressione
- piano superiore in laminato
- 3 prese di corrente, situate sotto la cassettera, su ogni posto di lavoro
- 2 cassetti corredati di bacinelle in PVC su ogni posto lavoro
- cassonetto con 4 cassetti

MOBILI DI SERVIZIO

Aggiungere ad ogni elemento il prezzo del supporto a pavimento o del basamento, del piano, dell'alzatina, del lavello e del rubinetto.

I moduli su misura possono essere realizzati solo con anta: applicare il prezzo dell'articolo di misura superiore con un supplemento del 25%.

CAPPE

Tutte le cappe hanno le seguenti dotazioni di serie:

- aspirazione 60 W – 600m³/h, uscita fumi Ø 150 mm
- illuminazione
- 2 prese e spine di corrente nelle cappe L. 1200 e L. 1600 mm
- chiusura con cristallo temperato scorrevole e piano in acciaio inox.
- comandi elettrici sulla parte frontale
- altezza con cristallo aperto 2400 mm

CAPPE PENSILI

Tutte le cappe pensili hanno le seguenti dotazioni di serie:

- aspirazione 300 W – 1500 m³/h con filtro in acciaio inox, uscita fumi Ø 200 mm
- illuminazione
- comandi elettrici posizionati sulla parte frontale.

Dimensioni: L = larghezza P = profondità H = altezza

BENCHES

All benches have the following standard features:

- electrical system
- predisposition for suction system
- compressed air system complete with syringe, pressure gauge and pressure reducer
- laminate-top
- 3 sockets fixed under the drawer pack, for each work station
- 2 drawers provided with PVC basins, for each work station
- drawer box with 4 drawers

SERVICE UNITS

Add the price of the floor support or base, top, splashback, sink and mixer to each unit. Made-to-measure units: apply the price of the item with the next greater size and add a 25% extra charge.

HOODS

All hoods have the following standard features:

- suction system 60W – 600m³/h, fumes exit Ø 150mm
- lighting system
- 2 sockets with plugs in the hoods L. 1200 e L. 1600mm
- hardened glass sliding door and stainless steel top
- electrical controls on the front panel
- H. 2400mm with opened glass

SUSPENDED HOODS

All suspended hoods have the following standard features:

- suction system 300W – 1500 m³/h with a stainless steel filter, fumes exit Ø 200mm
- lighting system
- electrical controls on the front panel

Dimensions: L = width P = depth
H = height

ETABLIS

Tous les établis possèdent les équipements de série suivants:

- système électrique
- prédisposition pour système d'aspiration
- système d'air comprimée avec soufflette, manomètre et réducteur de pression
- dessus en mélaminé
- 3 prises de courant, positionnées sous les tiroirs, pour chaque poste de travail
- 2 tiroirs équipés de cuvettes en PVC, pour chaque poste de travail
- meuble supplémentaire avec 4 tiroirs

MODULES DE SERVICE

À chaque module il faut ajouter le prix de: support au sol, base, plan, dossier, évier et robinet.

Les modules sur mesure peuvent être réalisés uniquement avec une porte: appliquer le prix de l'article de mesure supérieure et ajouter un supplément de 25%.

HOTTES

Toutes les hottes possèdent les équipements de série suivants:

- système d'aspiration 60W – 600m³/h, sortie de la fumée Ø 150mm
- éclairage
- 2 prises de courant femelle+mâles dans les hottes L. 1200 et L. 1600mm
- fermeture avec vitre coulissante en verre trempé et dessus en acier inox
- commandes électriques positionnées sur la partie devant
- H. 2400mm avec vitre ouverte

HOTTES MURALES

Toutes les hottes murales possèdent les équipements de série suivants:

- système d'aspiration 300W – 1500m³/h avec filtre en acier inox, sortie de la fumée Ø 200mm
- éclairage
- commandes électriques positionnées sur la partie devant

Dimensions: L = largeur P = profondeur H = hauteur

ARBEITSTISCHE

Alle Arbeitstische haben die folgende Standardausstattung:

- elektrische Installationen
- bereit zum Anschluss einer Absaugung
- Druckluftanlage, mit Luftbläser, Manometer und Druckminderer
- Laminat-Arbeitsplatte
- 3 Steckdosen unter dem Schubladensatz für jeden Arbeitsplatz
- 2 Schubladen ausgestattet mit PVC-Schubladeneinsatz für jeden Arbeitsplatz
- Schubladenkasten mit 4 Schubladen

FUNKTIONSMÖBEL

Bei jedem Element muss der Preis des Bodengestells oder Sockels, der Ebene, der Aufkantung, des Waschbeckens und des Wasserhahns separat berechnet werden. Maßgefertigte Module können nur mit Tür hergestellt werden: auf den Preis des nächst größeren Artikels einen Mehrpreis von 25% berechnen.

OFENSCHRÄNKE

Alle Ofenschränke haben die folgende Standardausstattung:

- Absaugvorrichtung 60W – 600m³/h
- Dampfaustritt Ø 150 mm
- Beleuchtung
- 2 Steckdosen mit Steckern in Ofenschränken B.1200 mm und B.1600 mm,
- Schiebetür aus Hartkristall und Edelstahlarbeitsplatte
- die Bedieneinheit befindet sich auf dem Frontpaneel.
- H. 2400 mm mit geöffneter Schiebetür.

WANDABZUGSHAUBEN

Alle Wandabzugshauben haben die folgende Standardausstattung:

- Absaugvorrichtung 300W – 1500 m³/h mit Edelstahlfilter
- Dampfaustritt Ø 200mm
- Beleuchtung
- Die Bedieneinheit befindet sich auf dem Frontpaneel

Maße: L = Breite P = Tiefe H = Höhe

BANCOS

Todos los bancos están equipados de serie como a continuación:

- instalación eléctrica
- preajuste para el equipo de aspiración
- instalación de aire comprimido provista de jeringa, manómetro y reductor de presión
- encimera superior de laminado
- instalación eléctrica con 3 tomas de corriente, posicionadas debajo de la cajonera, en cada puesto de trabajo
- 2 cajones equipados con bandejas de PVC en cada puesto de trabajo
- cajonera con 4 cajones

MUEBLES

Añadir a cada elemento el precio del soporte de pie, o de la base, de la encimera, de la alzada, del lavabo y del grifo.

Los muebles a medida pueden realizarse sólo con la puerta: aplicar el precio del artículo de medida superior con un recargo del 25%.

CAMPANAS

Las campanas están provistas de:

- aspiración 60W – 600m³/h
- salida de los humos Ø 150 mm
- Iluminación
- 2 tomas y enchufes de corriente (campanas A.1200 mm y A.1600 mm)
- cierre con cristal templado corredero y encimera de acero inoxidable.
- Los controles están situados sobre el panel frontal.
- Alto 2400 mm con cristal templado corredero abierto.

CAMPANAS COLGANTES

Las campanas colgantes están provistas de:

- aspiración 300W – 1500 m³/h con filtro de acero inoxidable
- salida de los humos Ø 200mm
- Iluminación
- los controles están situados sobre el panel frontal

Dimensiones: L = Ancho P = Profundidad H = Alto

VERSIONE STANDARD

Struttura: Ral 9010 Goffrato

Frontale: Bianco Loran / Arancio Ral 2001 / Blu Ral 5002 / Verde Ral 6019 / Grigio Ral 7045

Colori diversi in scala Ral supplemento del 5% *

Colori metallizzati o non Ral: supplemento del 10% *

Maniglie: Bianco Opaco / Ral 9006

Maniglie in alluminio anodizzato: + € 13,00 cad.

* Per i colori, vedi tabella RAL

STANDARD VERSION

Carcase: Ral 9010 embossed

Front: Loran white / Orange Ral 2001 / Blue Ral 5002 / Green Ral 6019 / Grey Ral 7045

Different colours of the Ral range available with a 5% surcharge* - Metallic and non-Ral colours attract a 10% surcharge*

Handles: matt white / Ral 9006

Anodized aluminum handles: + € 13.00 each

* For colours see RAL chart

VERSION STANDARD

Structure: Ral 9010 Gaufré

Façade: Bianco Loran / Orange Ral 2001 / Bleu Ral 5002 / Vert Ral 6019 / Gris Ral 7045

Coloris différents à l'échelle Ral supplément de 5%* - Couleurs métallisées ou non Ral : supplément de 10%*

Poignées: Blanc Mat/Ral 9006

Poignées en aluminium anodisé : + 13,00 € chacune

* Pour les coloris, voir tableau RAL

STANDARDVERSION

Korpus: RAL 9010 strukturiert

Front: Weiß Loran / Orange RAL 2001 / Blau RAL 5002 / Grün RAL 6019 / Grau RAL 7045

Andere Farben der RAL-Farbskala Mehrpreis von 5%* - Metallic-Farben oder keine RAL-Farben: Mehrpreis von 10%*

Griffe: Weiß Matt / Ral 9006

Griffe aus eloxiertem Aluminium: + € 13,00 pro St

* Farben siehe RAL-Farbtabelle

MODELO ESTANDAR

Estructura: Ral 9010 Gofrado

Frente: Blanco Loran / Naranja Ral 2001 / Azul Ral 5002 / Verde Ral 6019 / Gris Ral 7045

Colores distintos en la escala Ral recargo del 5%* - Colores metalizados o no Ral: recargo del 10%*

Tiradores: Blanco Opaco / Ral 9006

Tiradores de aluminio anodizado: + € 13,00 cada uno

* Para los colores, véase la tabla RAL

MAESTRO | Piani Tops / Plans / Arbeitsplatte / Encimeras

I mobili di servizio sono disponibili in due versioni di piano:

- Piano laminato



- Piano Inox

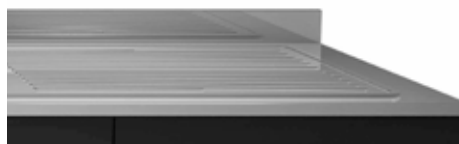

Modular service tops are available in two versions:

- Laminate top

- Stainless steel top

Les meubles de service sont disponibles en deux versions de plan:

- Plan laminé

- Plan inox

Die modular aufgebauten Funktionsmöbel sind mit zwei verschiedenen Arbeitsplatten erhältlich:

- Laminat-Arbeitsplatte

- Edelstahl-Arbeitsplatte

Los muebles están disponibles con encimera en dos versiones:

- Encimera de laminado

- Encimera de acero inoxidable

FINITURE VERNICIATE RAL

RAL painted finishes / Finitions vernies RAL / RAL-Lackierten Ausführungen / Acabados pintados RAL

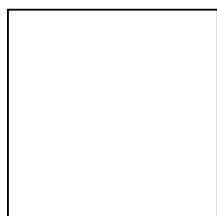

BIANCO



RAL 2001



RAL 5002



RAL 6019



RAL 7045

Questo campionario deve essere considerato solo come guida indicativa del colore e non può essere utilizzato come riferimento originale per la produzione e la valutazione di superfici colorate.

This sample should only be considered as an indicative colour guide and cannot be used as an original reference for the production and assessment of colored surfaces.

Ce nuancier ne sert qu'à donner une idée des différents coloris et ne doit en aucun cas être utilisé comme référence originale pour la production et l'évaluation des surfaces colorées.

Diese Farbmuster sind unverbindlich und können vom Original Farbton der hergestellten Oberflächen abweichen.

Esta muestra de colores debe considerarse sólo como una guía indicativa del color, y no puede utilizarse como referencia original para la producción y evaluación de las superficies pintadas.

MAESTRO | Maniglie

Handles / Poignées / Griffe / Tiradores

Maniglie di serie disponibili nei colori:

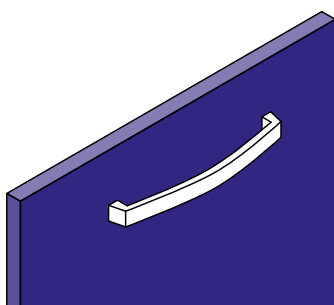

BIANCO OPACO

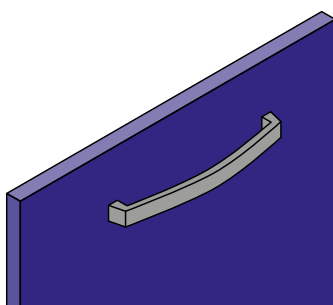

RAL 9006

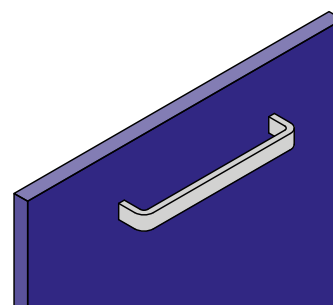

ALLUMINIO ANODIZZATO

Standard handles available in the following colours:

- MATT WHITE
- RAL 9006
- ANODISED ALUMINIUM

Poignées en série disponibles dans les coloris :

- BLANC MAT
- RAL 9006
- ALUMINIUM ANODISÉ

Griffe serienmäßig erhältlich in den Farben:

- WEISS MATT
- RAL 9006
- ANODISIERTES ALUMINIUM

Tiradores de serie disponibles en los colores:

- BLANCO OPACO
- RAL 9006
- ALUMINIO ANODIZADO

Mobile con piedini

Per gli articoli, vedi pag. 189

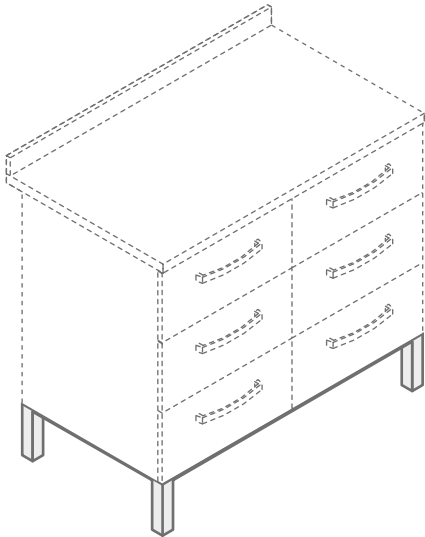

Mobile con basamento

Per gli articoli, vedi pag. 191

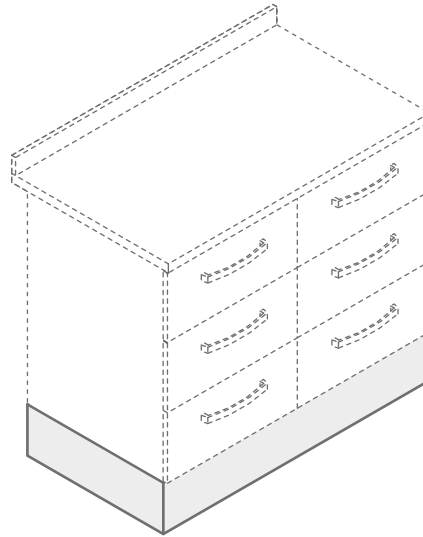

I mobili di servizio, le basi sottocappa e le cappe aspiranti devono sempre essere completati con l'aggiunta di supporti con piedini o basamenti.

Modular service units and units below suction hoods must always be fitted with feet or a basement.

Unit with feet

For more details see on page 190

Unit with basement

For more details see on page 192

Les meubles modulaires de service et les meubles sous-hotte et pour hottes aspirantes doivent toujours être complétés par l'ajout de pieds ou de bases.

Meuble avec pieds

Pour les articles, voir page 190

Meuble avec base

Pour les articles, voir page 192

Die modular aufgebauten Funktionsmöbel sowie die Möbel unter der Abzugshaube und für Abzugshauben müssen immer auf Füßen oder auf einem geschlossenen Sockel aufgestellt werden.

Möbel mit Füßen

Artikel siehe Seite 190

Möbel mit geschlossenem Sockel

Artikel siehe Seite 192

Los muebles modulares y los muebles debajo de la campana y para campanas extractoras deben siempre equiparse con patas o bases.

Mueble con patas

Para los artículos, véase la pág. 190

Mueble con base

Para los artículos, véase la pág. 192

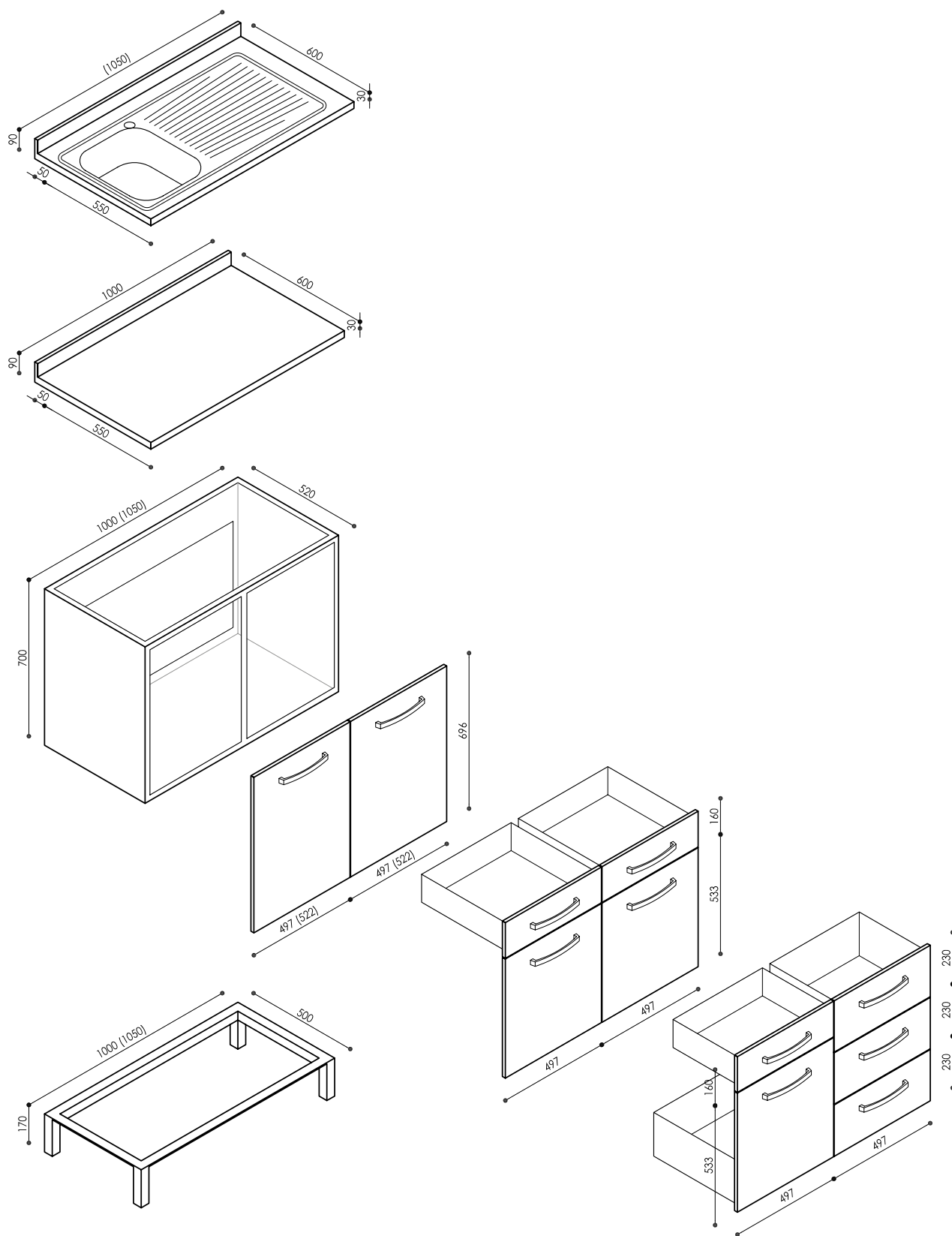

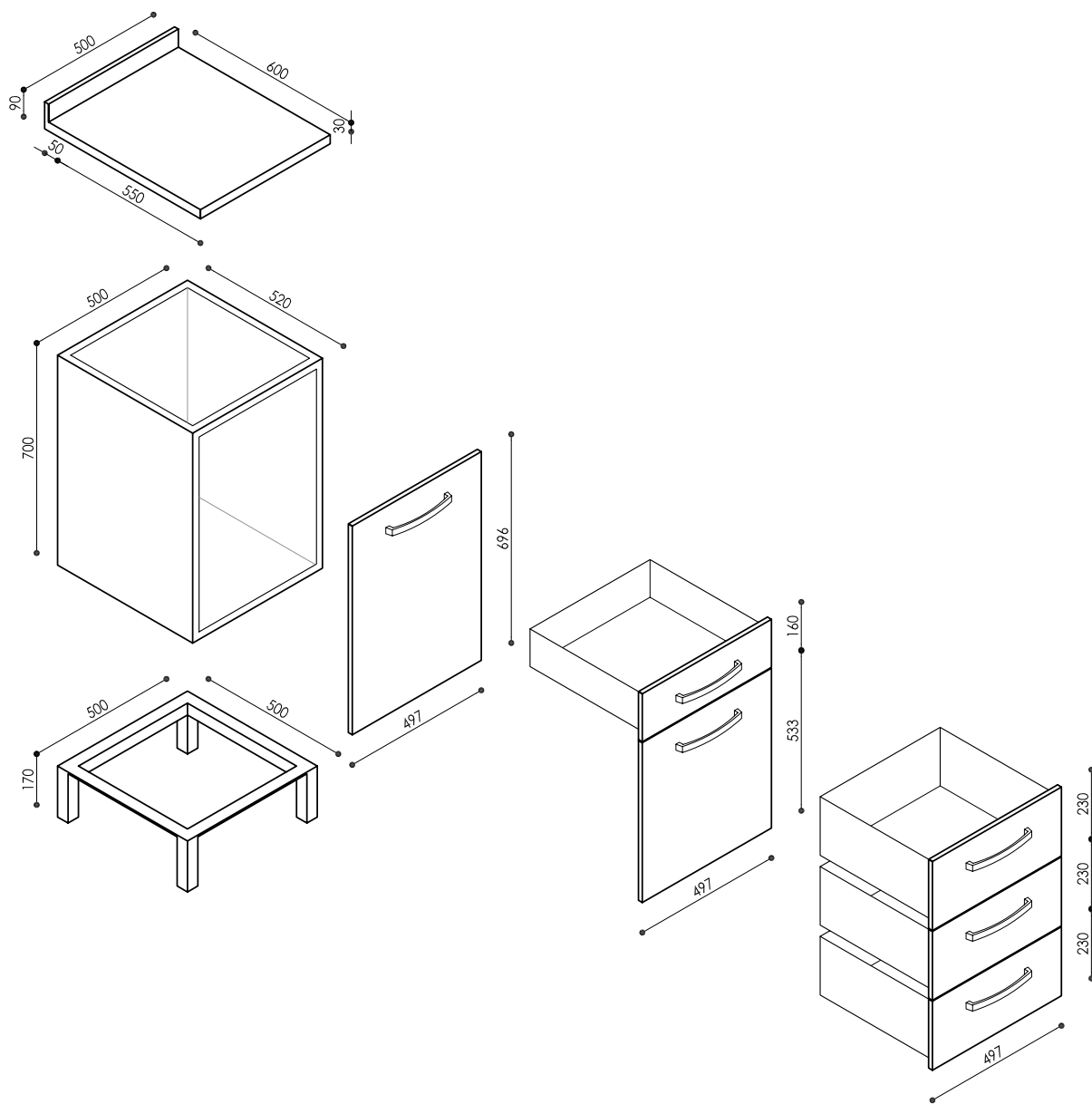

VELA

LOOK

LIKE

ALA / QUADRO
NOVO / UPRIGHT

MOVINGTRAY
MOVING ARM

PURRA
PURASTUDIO

STERIL K

CART

ARMADI

BACINELLE

PIANI
ALZATINE

LAVELLI
RUBINETTI

LAVORAZIONI
ACCESSORI

OPEN BOX
SEGGIOLINI

PROF

MAESTRO

IMPIANTISTICA

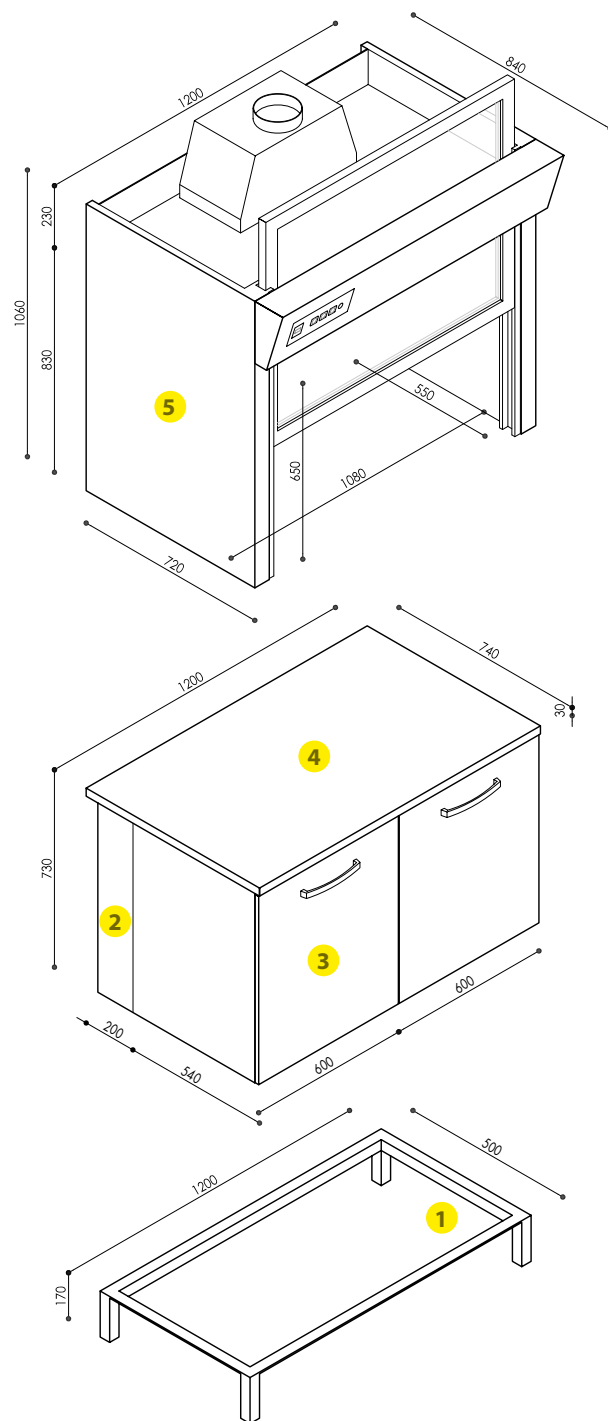

CAPPA ASPIRANTE MAESTRO - Versione su piedi

1 - Supporto a pavimento 2 - Tamponamento laterale; 3 - Base sottocappa; 4 - Piano in acciaio inox; 5 - Sopracappa.

MAESTRO SUCTION HOOD - Version on feet

1 - Floor support; 2 - Closing panel; 3 - Hood base; 4 - Stainless steel top; 5 - Upper part suction hood.

HOTTE ASPIRANTE MAESTRO - Version sur pieds

1 - Support au sol; 2 - Cache de fermeture; 3 - Partie basse pour hotte; 4 - Plan de travail inox; 5 - Partie supérieure hotte aspirante.

OFENSCHRANK MAESTRO - Version auf Füßen

1 - Bodengestell; 2 - Verschlussverkleidung; 3 - Basis für Ofenschränk; 4 - Edelstahl-arbeitsplatte; 5 - Oberkörper Ofenschränk.

CAMPANA APSIRANTE MAESTRO - Versión con patas

1 - Soporte de pie; 2 - Panel de cierre; 3 - Elemento debajo de la campana; 4 - Encimera de acero inoxidable; 5 - Parte superior campana aspirante.

MAESTRO | Cappe

Suction hoods / Hottes aspirants / Ofenschränke / Campana aspirante

LORAN

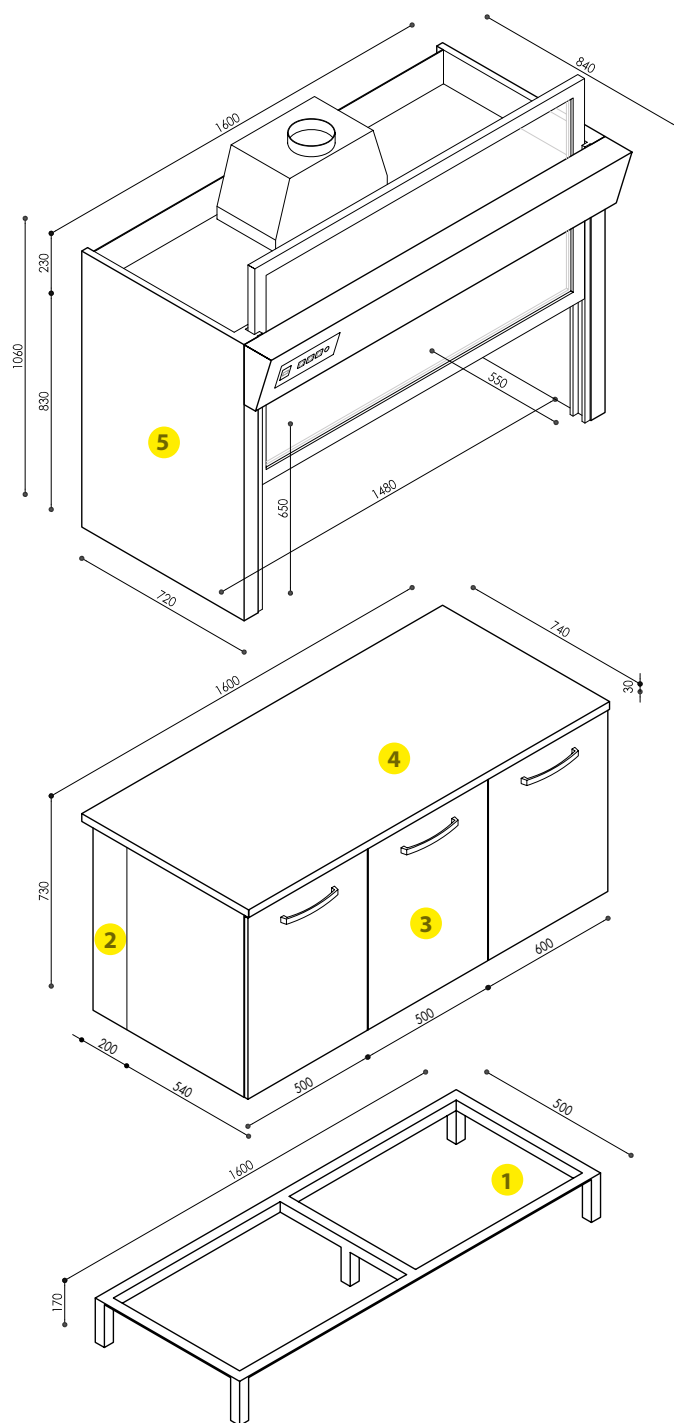

CAPPA ASPIRANTE MAESTRO - Versione su piedi

1 - Supporto a pavimento 2 - Tamponamento laterale; 3 - Base sottocappa; 4 - Piano in acciaio inox; 5 - Sopracappa.

MAESTRO SUCTION HOOD - Version on feet

1 - Floor support; 2 - Closing panel; 3 - Hood base; 4 - Stainless steel top; 5 - Upper part suction hood.

HOTTE ASPIRANTE MAESTRO - Version sur pieds

1 - Support au sol; 2 - Cache de fermeture; 3 - Partie basse pour hotte; 4 - Plan de travail inox; 5 - Partie supérieure hotte aspirante.

OFENSCHRANK MAESTRO - Version auf Füßen

1 - Bodengestell; 2 - Verschlussverkleidung; 3 - Basis für Ofenschränk; 4 - Edelstahl-arbeitsplatte; 5 - Oberkörper Ofenschränk.

CAMPANA APSIRANTE MAESTRO - Versión con patas

1 - Soporte de pie; 2 - Panel de cierre; 3 - Elemento debajo de la campana; 4 - Encimera de acero inoxidable; 5 - Parte superior campana aspirante.

VELA

LOOK

LIKE

ALA / QUADRO
NOVO / UPRIGHT

MOVINGTRAY
MOVING ARM

PURA
PURASTUDIO

STERIL K

CART

ARMADI

BACINELLE

PIANI
ALZATINE

LAVELLI
RUBINETTI

LAVORAZIONI
ACCESSORI

OPEN BOX
SEGGIOLINI

PROF

MAESTRO

IMPIANTISTICA

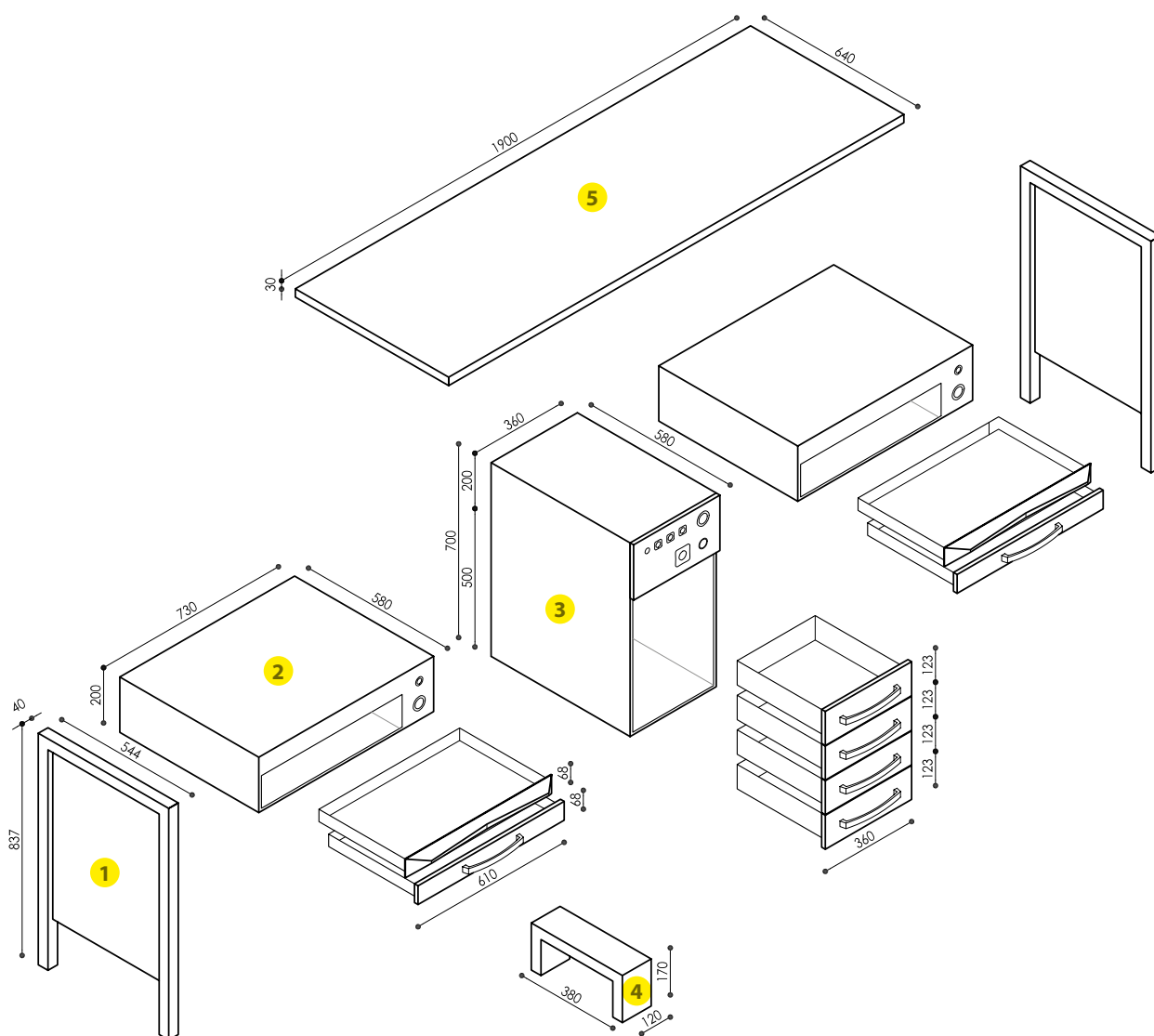

BANCO PER 2 POSTI DI LAVORO MAESTRO

1 - Supporto laterale; 2 - Cassettiera posto lavoro; 3 - Cassonetto banco; 4 - Supporto cassonetto banco MF; 5 - Piano in laminato grigio.

BENCH FOR DOUBLE WORK STATION MAESTRO

1 - Lateral support; 2 - Drawer pack for bench; 3 - Drawer box for bench; 4 - Drawer box support for bench MF; 5 - Grey laminate-surfaced.

ETABLI POUR DEUX POSTE DE TRAVAIL MAESTRO

1 - Support lateral; 2 - Rangement a tiroirs pour etabli; 3 - Boite tiroirs pour etabli; 4 - Support pour boite tiroirs pour etabli MF; 5 - Plan en laminé gris;

DOPELARBEITSTISCH MAESTRO

1 - Seitenpanel zum Abstützen; 2 - Schubladenschrank für Tisch; 3 - Schubladenbox für Tisch; 4 - Schubladenboxabstützung für Tisch MF; 5 - Grau Laminatarbeitsplatte.



MESA PARA DOS PUESTOS DE TRABAJO MAESTRO

1 - Soporte lateral; 2 - Cajonera para mesa; 3 - Caja para mesa; 4 - Soporte para caja para mesa MF; 5 - Tablero de laminado gris.

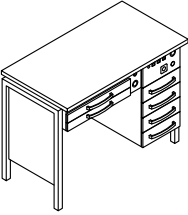
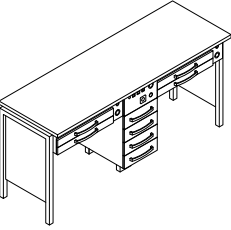
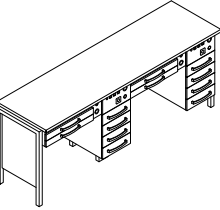
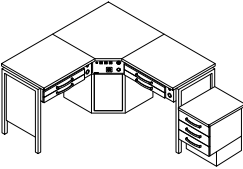
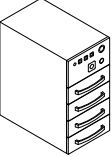
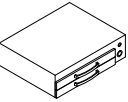
H Sottopiano: / H Under the top: / H Sous plan de travail: / H Unter der Arbeitsplatte: / A Bajo encimera: 900 mm

	Descrizione / Description Description / Beschreibung / Descripción	M³ Kg	Articolo Item / Article Artikel / Artículo	Prezzo Price / Prix Preis / Precio
	BANCO PER UN POSTO DI LAVORO completo di: n. 1 cassonetto Bench for single work station complete of: n.1 Drawer box Etabli pour un poste de travail complet de: n.1 Boite tiroirs Einzelarbeitstisch komplett mit: n.1 Schubladenbox Mesa para un puesto de trabajo completo de: n. 1 Caja	0,7 75,5	MF1	€ 1.886,00
L 1175 x P 640 x H 900 mm				
	BANCO PER DUE POSTI DI LAVORO completo di: n. 1 cassonetto Bench for double work station complete of: n.1 Drawer box Etabli pour deux poste de travail complet de: n.1 Boite tiroirs Doppelarbeitsstisch komplett mit: n.1 Schubladenbox Mesa para dos puestos de trabajo completo de: n. 1 Caja	1,1 104	MF2	€ 2.735,00
L 1905 x P 640 x H 900 mm				
	BANCO PER DUE POSTI DI LAVORO completo di: n. 2 cassonetti Bench for double work station complete of: n.2 Drawer boxes Etabli pour deux poste de travail complet de: n.2 Boites tiroirs Doppelarbeitsstisch komplett mit: n.2 Schubladenboxen Mesa para dos puestos de trabajo completo de: n. 2 Cajas	1,3 138	MF2-CO	€ 3.584,00
L 2265 x P 640 x H 900 mm				
	BANCO AD ANGOLO, sdoppiato destro o sinistro, e cassonetto portaforno con vano per pompa Corner bench, with rh or lh corner and oven box with pump compartment Etabli en angle, dédoublé droit ou gauche, et tiroir pour four avec rangement de la pompe Ecklösung mit schrank für den keramikofen (links oder rechts) und öffnung für die pumpe Banco en ángulo, derecho o izquierdo, y cajón portahorno con espacio para bomba	3,1 122	MFSD	€ 3.805,00
L 1625 x P 2125 x H 900 mm				
	Cassonetto banco MF Drawer box for bench MF Boite tiroirs pour etabli MF Schubladenbox für Tisch MF Caja para mesa MF	0,1 30	MCO	€ 797,00
L 360 x P 595 x H 900 mm				
	Cassettiera posto lavoro banco MF Drawer pack for bench MF Rangement a tiroirs pour etabli MF Schubladenschrank für Tisch MF Cajonera para mesa MF	0,1 15	MCA	€ 620,00
L 730 x P 595 x H 200 mm				

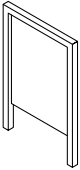
VELA
LOOK
LIKE
ALA/QUADRO NOVO/UPRIGHT
MOVINGTRAY MOVING ARM
PURA PURASTUDIO
STERIL K
CART
ARMADI
BACINELLE
PIANI ALZATINE
LAVELLI RUBINETTI
LAVORAZIONI ACCESSORI
OPEN BOX SEGGIOLINI
PROF
MAESTRO
IMPIANTISTICA

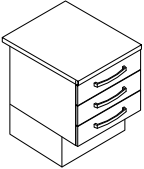
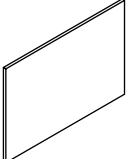
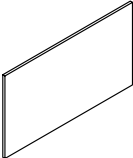
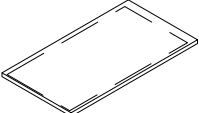
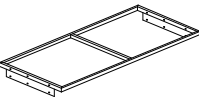
	Descrizione / Description Description / Beschreibung / Descripción	M³ Kg	Articolo Item / Article Artikel / Artículo	Prezzo Price / Prix Preis / Precio
 L 544 x P 40 x H 837 mm	Supporto laterale banco MF Lateral support for bench MF Support lateral pour etabli MF Seitenwand für Tisch MF Soporte lateral para mesa MF	- 10	MCL	€ 148,00
 L 120 x P 380 x H 170 mm	Supporto cassonetto banco MF Drawer box support for bench MF Support pour boite tiroirs pour etabli MF Schubladenboxabstützung für Tisch MF Soporte para caja para mesa MF	- 3	MCS	€ 121,00
 L 500 x P 640 x H 700 mm	Cassonetto supplementare portaforno con vano per pompa Additional oven unit with pump compartment Petit meuble supplémentaire pour four avec rangement de la pompe Zusätzlicher Keramikofenschrank und Öffnung für die Pumpe Cajonera adicional portahorno con espacio para bomba	0,2 33	MFSU	€ 664,00
 L 730 x P 10 x H 500 mm	Schiena posteriore banco lineare Rear panel for bench Panneau arrière pour etabli Rückseite für Tisch Panel posterior por banco	- 4	MSCN	€ 135,00
 L 892 x P 10 x H 500 mm	Schiena posteriore banco angolare Rear panel for corner bench Panneau arrière pour etabli d'angle Rückseite für EckTisch Panel posterior por banco en ángulo	- 5	MSCA	€ 160,00
 L a misura x P 640 x H 30 mm	Piano banco MF: al metro lineare Worktop for bench MF: per meter Dessus pour etabli MF: au metre Arbeitsplatte für Tisch MF: je Meter Tablero para mesa MF: al m.	- 11	MPBF	€ 210,00
 L ---- x P ---- x H ----	Telaio supporto piano a sbalzo: al metro lineare Frame to support the top: per meter Châssis pour soutenir le plan: au metre Rahmen für Arbeitsplatte: je Meter Frame para apoyar las encimeras: al m. Minimo fatturabile: 1 metro lineare Minimum charge: 1 meter Base minimale de facturation: 1 mètre Mindestgebühr: 1meter Mínimo facturable: 1 metro	- 11	STSM	€ 184,00

VELA

LOOK

LIKE

ALA/QUADRO
NOVO/UPRIGHTMOVINGTRAY
MOVING ARMPURA
PURASTUDIO

STERIL K

CART

ARMADI



BACINELLE

PIANI
ALZATINELAVELLI
RUBINETTILAVORAZIONI
ACCESSORIOPEN BOX
SEGGIOLINI

PROF



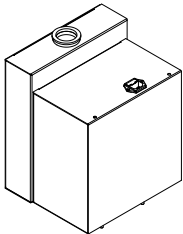

MAESTRO

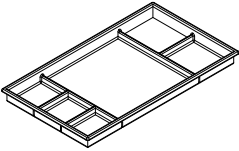
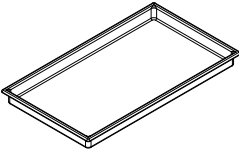
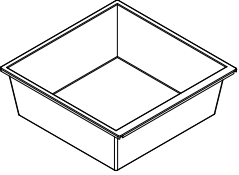
IMPIANTISTICA

	Descrizione / Description Description / Beschreibung / Descripción	M³ Kg	Articolo Item / Article Artikel / Artículo	Prezzo Price / Prix Preis / Precio
 <p>Aspirazione per 1 posto di lavoro con motore a spazzola, filtro e regolatore di giri</p> <p>Suction for one work station with motor brush, filter and revolution-control</p> <p>Aspiration à un poste de travail avec moteur à balais, filtre et tours-control</p> <p>Absaugung mit variabler Saugleistung für einen Arbeitsplatz, Filter und Drehzahlregler</p> <p>Aspiración para un puesto de trabajo, con el motor del cepillo, filtro y regulador de revoluciones</p> <p>L 230 x P 240 x H 290 mm</p>		- ----- 6	A1F	€ 990,00
 <p>Aspirazione per 1 posto di lavoro con motore a induzione (Renfert Silent Compact)</p> <p>Suction for one work station with induction (Renfert Silent Compact)</p> <p>Aspiration à un poste de travail avec moteur à induction (Renfert Silent Compact)</p> <p>Absaugung mit Induktionsmotor (Renfert Silent Compact)</p> <p>Aspiración para 1 puesto de trabajo, con el motor de inducción (Renfert Silent Compact)</p>		- ----- -	A1R	<p>Disponibile per la nostra gamma di prodotti</p> <p>Available for our product range</p> <p>Disponible pour notre gamme de produits</p> <p>Für unsere Produktpalette erhältlich</p> <p>Disponibile para nuestra gama de productos</p>
 <p>Accensione automatica aspirazione con il funzionamento del micromotore, una per ogni posto di lavoro</p> <p>Micromotor-operated automatic suction, one for each suction-motor</p> <p>Allumage automatique de l'aspiration par fonctionnement du micromoteur, un pour chaque moteur d'aspiration</p> <p>Automatischer Start der Absauganlage mit Betrieb des Mikromotors, ein für jeden Absaugmotor</p> <p>Encendido automático de la aspiración con el funcionamiento del micromotor, una para cada motor de aspiración</p>		- ----- -	AAA	€ 181,00

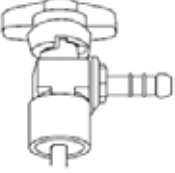
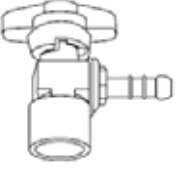
	Descrizione / Description Description / Beschreibung / Descripción	M³ Kg	Articolo Item / Article Artikel / Artículo	Prezzo Price / Prix Preis / Precio
	<p>Bacinella posto lavoro a scomparti</p> <p>Work station tray with compartments Intérieur de tiroir à compartiments Einsatz mit Fächern Bandeja para puesto de trabajo con compartimientos</p>	- 0,4	B07	€ 18,00
L 540 x P 310 x H 40 mm				
	<p>Bacinella posto lavoro liscia</p> <p>Flat work station tray Intérieur de tiroir plat Einsatz ohne Profile Bandeja plana para puesto de trabajo</p>	- 0,4	B08	€ 18,00
L 540 x P 310 x H 40 mm				
	<p>Bacinella per il gesso</p> <p>Plaster tray Intérieur de tiroir pour plâtre Einlage für Gips Bandeja para el yeso</p>	- 0,8	B10M	€ 37,00
L 430 x P 450 x H 150 mm				

	Descrizione / Description Description / Beschreibung / Descripción	M³ Kg	Articolo Item / Article Artikel / Artículo	Prezzo Price / Prix Preis / Precio
	<p>Protezione inox per posto lavoro</p> <p>Stainless steel guard for work station Protéction inox pour poste de travail Edeltstahlarbeitsunterlage Protección de acero inoxidable para el puesto de trabajo</p>	- 0,7	PRI	€ 53,00
L 360 x P 225 x H 31 mm				
	<p>Caviglia chiusa per posto lavoro</p> <p>Closed-peg for work station Chéville fermée en bois Feilkloben aus Holz Astillera cerrada para puesto de trabajo</p>	- 0,2	CAVM	€ 86,00
	<p>Caviglia forata per posto lavoro con aspirazione</p> <p>Perforated-peg for work station with suction apparatus Chéville perforée pour aspiration Feilkloben mit Absaugmaul Astillera perforada para puesto de trabajo con aspiración</p>	- 0,2	CAS	€ 97,00
	<p>Caviglia forata per posto lavoro con aspirazione con protezione in vetro</p> <p>Perforated-peg for work station with suction apparatus and glass protection Chéville perforée pour aspiration avec protection en verre Feilkloben mit Absaugmaul und Glasschutz Astillera perforada para puesto de trabajo con aspiración y protección de vidrio</p>	- 0,2	CAR	€ 122,00
	<p>Frontalino in legno appoggia braccia per un cassetto posto lavoro</p> <p>Front panel armrest in wood, for one drawer Façade accoudoir en bois, pour un tiroir poste de travail Frontplatte Armstützen aus Holz, für eine Schublade Panel frontal apoyabrazos en madera, para 1 cajón del puesto de trabajo</p>	- 1	MFAL	€ 117,00
L 640 x P 51 x H 68 mm				

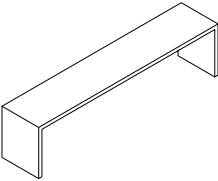
	Descrizione / Description Description / Beschreibung / Descripción	M³ Kg	Articolo Item / Article Artikel / Artículo	Prezzo Price / Prix Preis / Precio	
	Rubinetto e tubo gas Gas plant and gas valve Système à gaz et robinet de gaz Vorinstallierte Gasarmaturen mit Gashahn Plantas de gas y válvula de gas	- -	IRG	€ 94,00	ALA/QUADRO NOVO/UPRIGHT MOVINGTRAY MOVING ARM
	Rubinetto gas Gas cock Robinet de gaz Gashahn Grifo de gas	- -	RUG	€ 53,00	PURA PURASTUDIO STERIL K
	Sistema richiamo per micromotore Retrieval system for micromotor Système de retour pour micromoteur Kabel-Rückholssystem für Mikromotor Recuperación del sistema para micromotor	- -	SRM	€ 233,00	CART ARMADI
	Sacco filtro in carta per banco Paper bag for workbench Sac en papier pour établi Papiersack für Arbeitstisch Saco de papel para banco de trabajo	- -	SFB	€ 6,00	BACINELLE PIANI ALZATINE
	Sacco filtro in tessuto per banco Tissue bag for workbench Sac en tissu pour établi Stoffsack für Arbeitstisch Saco de tejido para banco de trabajo	- -	SFT	€ 64,00	LAVELLI RUBINETTI LAVORAZIONI ACCESSORI
	Mensola soprapiano per un posto di lavoro Shelf for one work station Etagère Regal Estante	- 6	MB1	€ 209,00	OPEN BOX SEGGIOLINI PROF MAESTRO

L 860 x P 170 x H 205 mm

MAESTRO | Accessori per banchi

LORAN

Benches accessories / Accessoires pour établis / Zubehörteile für Arbeitstische / Accesorios para bancos

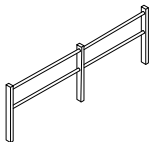
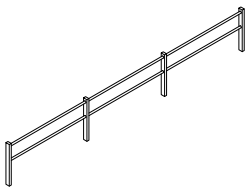
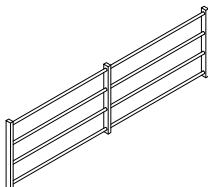
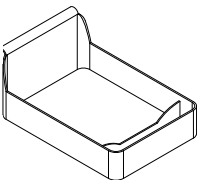
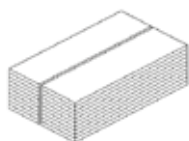
	Descrizione / Description Description / Beschreibung / Descripción	M³ Kg	Articolo Item / Article Artikel / Artículo	Prezzo Price / Prix Preis / Precio
	<p>Supporto per 6 bacinelle portalavori banco un posto</p> <p>6-workpiece basin support for single work station bench Support de 6 bassinets BPL pour établi un poste Regalschienensystem für Einzelarbeitstisch (6 Arbeitschalen) Soporte para 6 bandejas BPL para banco de 1 puesto de trabajo</p>	- 2	SB1	€ 93,00
L 1080 x P 25 x H 275 mm				
	<p>Supporto per 9 bacinelle portalavori banco due posti</p> <p>9-workpiece basin support for double work station bench Support de 9 bassinets BPL pour établi deux postes Regalschienensystem für Doppelarbeitstisch (9 Arbeitschalen) Soporte para 9 bandejas BPL para banco de dos puestos de trabajo</p>	- 2,5	SB2	€ 113,00
L 1612 x P 25 x H 275 mm				
	<p>Supporto murale per 12 bacinelle portalavori</p> <p>Wall-fixed 12-workpiece basin support Support mural de 12 bassinets BPL Regalschienensystem für Wandmontage (12 Arbeitschalen) Soporte de pared para 12 bandejas BPL</p>	- 2,5	SMU	€ 146,00
L 1125 x P 25 x H 340				
	<p>Bacinella portalavori: arancio, blu, giallo, grigio, rosso, verde</p> <p>Workpiece basin: orange, blue, yellow, grey, red, green Bassinets porte travail: orange, bleu, jaune, gris, rouge, vert Arbeitschale: orange, blau, gelb, grau, rot, grün Bandeja portatrabajo: anaranjada, azul, amarilla, gris, roja, verde</p>	- 0,25	BPL	€ 14,00
L 170 x P 235 x H 110				
	<p>Confezione con 50 etichette per bacinelle portalavori</p> <p>50 label-pack for workpiece basins Paquet de 50 etiquettes pour bassinets porte travail Etikette für Arbeitschalen (50 Stck.) Paquete de 50 etiquetas para bandejas portatrabajo</p>	- -	CEP	€ 6,00

VELA

LOOK

LIKE

ALA/QUADRO
NOVO/UPRIGHTMOVINGTRAY
MOVING ARMPURA
PURASTUDIO

STERIL K

CART

ARMADI

BACINELLE

PIANI
ALZATINELAVELLI
RUBINETTILAVORAZIONI
ACCESSORIOPEN BOX
SEGGIOLINI

PROF

MAESTRO

IMPIANTISTICA

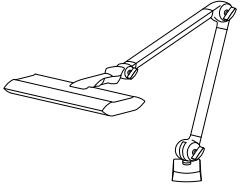
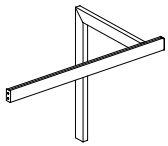
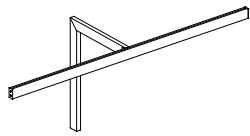
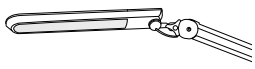
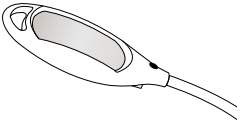
	Descrizione / Description Description / Beschreibung / Descripción	M³ Kg	Articolo Item / Article Artikel / Artículo	Prezzo Price / Prix Preis / Precio
	<p>Lampada snodata a LED, alimentatore elettronico 5000K, 14W</p> <p>Articulated LED lamp, electronic power supply 5000K, 14W Lampe à led avec bras articulé, alimentation électrique 5000 K, 14 W. LED-Gelenklampe, elektronisches Netzteil 5000K, 14W. Lámpara articulada de LED, potencia eléctrica 5000 K, 14W</p>	- ----- 2	L1S	€ 1.478,00
L 320 x P 120 x H 490				
	<p>Lampada banco un posto, alimentatore elettronico 5000K 26,2 W</p> <p>Lamp for 1-place bench, electric power supply 5000K 26,2 W Lampe pour établi 1 poste, alimentation électrique 5000K 26,2 W Lampe für Tisch Einzelarbeitstisch, Leistungselektronik 5000K 26,2 W Lámpara para mesa 1-plaza, potencia eléctrica 5000K 26,2 W</p>	0,3 ----- 10	ML1F	€ 525,00
L 950 x P 540 x H 700				
	<p>Lampada banco due posti, alimentatore elettronico 5000K 47,8W</p> <p>Lamp for 2-places bench, electric power supply 5000K 47,8W Lampe pour établi 2 postes, alimentation électrique 5000K 47,8W Lampe für Tisch Doppelarbeitstisch, Leistungselektronik 5000K 47,8W Lámpara para mesa 2-plazas, potencia eléctrica 5000K 47,8W</p>	0,7 ----- 15	ML2F	€ 829,00
L 1720 x P 540 x H 700				
	<p>Lampada snodata a LED Armlight Eclairé, alimentatore elettronico 6000K, 14W, 1200lm</p> <p>Articulated LED lamp, electronic power supply 6000K, 14W 1200lm (Armlight Eclairé) Lampe à led avec bras articulé, alimentation électrique 6000K, 14W, 1200lm (Armlight Eclairé) LED-Gelenklampe, elektronisches Netzteil 6000K, 14W, 1200lm (Armlight Eclairé) Lámpara articulada de LED, potencia eléctrica 6000 K, 14W, 1200lm (Armlight Eclairé)</p>	- ----- -	L2S	€ 414,00
Dim. testa 40x8x2 Lunghezza (braccio) 92				
	<p>Lampada flexy da banco a LED con lente ingrandente a 3 diottrie</p> <p>Flexy Counter lamp with LED lighting, magnifying len (3 diopters) Lampe de table flexy à LED avec loupe munie d'une lentille de 3 dioptries LED-Flexy-Tischleuchte mit Lupe mit 3 Dioptrien Vergrößerung Lámpara LED Flexy de sobremesa con lente de aumento de 3 dioptrías</p>	- ----- -	L3S	€ 352,00
Dim. scatola 88x34xh. 7,5 Lunghezza (tubo fles.) 50				

	Descrizione / Description Description / Beschreibung / Descripción	M³ Kg	Articolo Item / Article Artikel / Artículo	Prezzo Price / Prix Preis / Precio
	<p>Supporto per reostato a ginocchio per banco</p> <p>Knee operated rheostat support for bench Support à genou pour micromoteur, pour établi Knieanlasserbleche für Tisch Soporte de codillo del réostato para el banco</p>	- 2,5	SRG	€ 53,00
	<p>Seggiolino in faggio naturale</p> <p>Natural beech stool Siège de travail en bois naturel Arbeitsstuhl aus Buche natur Silla en madera de haya natural</p>	0,7 15	SEL Naturale natural naturel natur natural	€ 299,00
		0,7 15	SELB Laccato bianco white blanc weiß blanco	€ 322,00

L 430 x P 520 x H 900

VELA

LOOK

LIKE

ALA/QUADRO
NOVO/UPRIGHTMOVINGTRAY
MOVING ARMPURA
PURASTUDIO

STERIL K

CART

ARMADI

BACINELLE

PIANI
ALZATINELAVELLI
RUBINETTILAVORAZIONI
ACCESSORIOPEN BOX
SEGGIOLINI

PROF

MAESTRO

IMPIANTISTICA

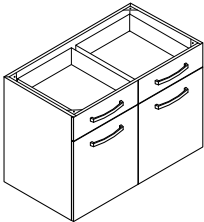
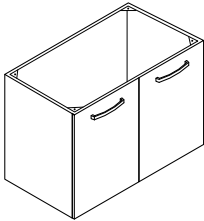
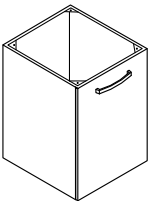
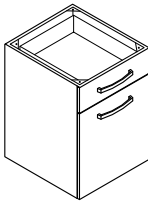
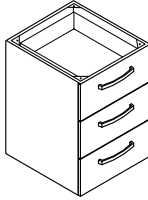
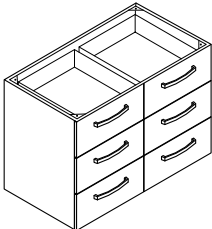
	Descrizione / Description Description / Beschreibung / Descripción	M³ Kg	Articolo Item / Article Artikel / Artículo	Prezzo Price / Prix Preis / Precio
	Modulare completo di 2 cassetti, 2 antine e ripiano interno Unit with 2 drawers, 2 doors and an interior shelf Module avec 2 tiroirs, 2 portes et 1 étagère interne Schrank mit 2 Schubladen und 2 Türen mit 1 Einlegeboden Módulo con 2 cajones, 2 puertas y 1 estante interior	0,4 61	M1	€ 917,00
L 1000 x P 540 x H 700 mm				
	Modulare completo di due antine e ripiano interno Unit with 2 doors and an interior shelf Module avec 2 portes avec 1 étagère interne Schrank mit 2 Türen mit 1 Einlegeboden Módulo con 2 puertas y 1 estante interior	0,4 53	M2	€ 809,00
L 1000 x P 540 x H 700 mm				
	Modulare completo di antina e ripiano interno Unit with door and an interior shelf Module avec porte avec 1 étagère interne Schrank mit Tür mit 1 Einlegeboden Módulo con 1 puerta y 1 estante interior	0,2 31	M3	€ 572,00
L 500 x P 540 x H 700 mm				
	Modulare completo di cassetto, antina e ripiano interno Unit with drawer, door and an interior shelf Module avec tiroir et porte avec 1 étagère interne Schrank mit 1 Schublade und 1 Tür mit 1 Einlegeboden Módulo con 1 cajón, 1 puerta y 1 estante interior	0,2 34	M4	€ 627,00
L 500 x P 540 x H 700 mm				
	Modulare completo di 3 cassetti Unit with 3 drawers Module avec 3 tiroirs Schrank mit 3 Schubladen Módulo con 3 cajones	0,2 45	M5	€ 711,00
L 500 x P 540 x H 700 mm				
	Modulare completo di 6 cassetti Unit with 6 drawers Module avec 6 tiroirs Schrank mit 6 Schubladen Módulo con 6 cajones	0,4 86	M6	€ 1.095,00
L 1000 x P 540 x H 700 mm				

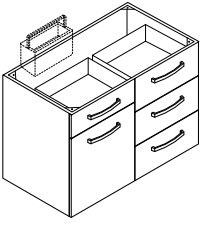
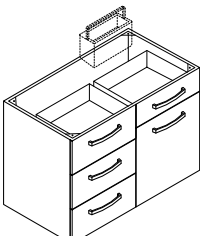
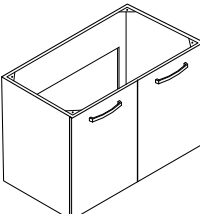
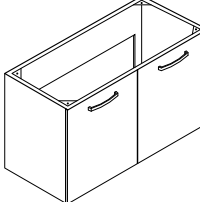
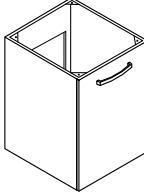
	Descrizione / Description Description / Beschreibung / Descripción	M ³ Kg	Articolo Item / Article Artikel / Artículo	Prezzo Price / Prix Preis / Precio
	<p>Modulare completo di cassetto per spatole, cassettono portarifiuti, 3 cassetti con bacinelle B10M per il gesso, protezione piano in gomma</p> <p>Unit with knife drawer, dustbin, 3 drawers with plaster trays B10M and rubber-surfaced top</p> <p>Module avec tiroir pour spatules, 1 grand tiroir poubelle, 3 tiroirs avec intérieurs B10M pour le plâtre et un protège-plateau en caoutchouc</p> <p>Schrank mit Schublade für Spatel, Abfallkorb, 3 Schubladen mit Einsätzen B10M für Gips, Arbeitsunterlage aus Gummi</p> <p>Módulo con cajón para las espátulas, cubo de basura, 3 cajones con bandejas B10M para el yeso, protección de goma para la encimera</p>	0,4 75	M10	€ 1.342,00
L 1000 x P 540 x H 700 mm				
	<p>Modulare completo di 3 cassetti con bacinelle B10M per il gesso, cassetto per spatole, cassettono portarifiuti, protezione piano in gomma</p> <p>Unit with 3 drawers with plaster trays B10M, knife drawer, dustbin and rubber surfaced-top</p> <p>Module avec 3 tiroirs avec intérieurs B10M pour le plâtre, 1 tiroir pour spatules, 1 grand tiroir poubelle et un protège-plateau en caoutchouc</p> <p>Schrank mit 3 Schubladen mit Einsätzen B10M für Gips, Schublade für Spatel, Abfallkorb, Arbeitsunterlage aus Gummi</p> <p>Módulo con 3 cajones con bandejas B10M para el yeso, cajón para las espátulas, cubo de basura, protección de goma para la encimera</p>	0,4 75	M11	€ 1.342,00
L 1000 x P 540 x H 700 mm				
	<p>Modulare lavello</p> <p>Sink unit Module évier Wasbeckenschrank rechts Modulo lavabo</p>	0,5 42	M14	€ 591,00
L 1050 x P 540 x H 700 mm				
	<p>Modulare lavello</p> <p>Sink unit Module évier Wasbeckenschrank rechts Modulo lavabo</p>	0,5 70	M16	€ 603,00
L 1200 x P 540 x H 700 mm				
	<p>Modulare lavello</p> <p>Sink unit Module évier Wasbeckenschrank rechts Modulo lavabo</p>	0,2 32	M20	€ 421,00
L 500 x P 540 x H 700 mm				

VELA

LOOK

LIKE

ALA/QUADRO
NOVO/UPRIGHTMOVINGTRAY
MOVING ARMPURA
PURASTUDIO

STERIL K

CART

ARMADI

BACINELLE

PIANI
ALZATINELAVELLI
RUBINETTILAVORAZIONI
ACCESSORIOPEN BOX
SEGGIOLINI

PROF

MAESTRO

IMPIANTISTICA

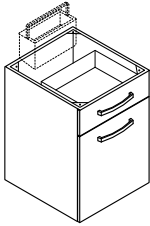
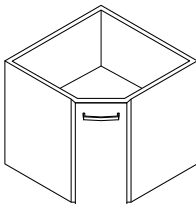
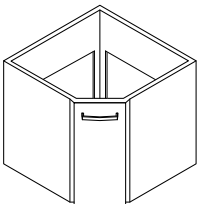
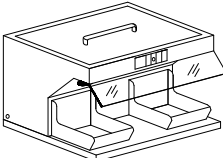
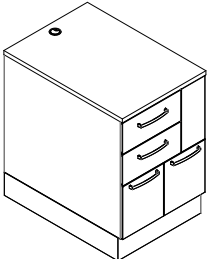
	Descrizione / Description Description / Beschreibung / Descripción	M ³ Kg	Articolo Item / Article Artikel / Artículo	Prezzo Price / Prix Preis / Precio
	<p>Modulare completo di cassetto per le spatole, cassettone portarifiuti e protezione piano in gomma</p> <p>Unit with knife drawer, dustbin and rubber-surfaced top Module complet avec tiroir pour spatules, 1 grand tiroir poubelle et protège-plateau en caoutchouc Schrank mit Schublade für Spatel, Abfallkorb und Arbeitsunterlage aus Gummi Módulo con cajón para las espátulas, cubo de basura y protección de goma para la encimera</p>	0,2 38	M22	€ 827,00
L 500 x P 540 x H 700 mm				
	<p>Modulare angolare con ripiano interno</p> <p>Corner unit with an interior shelf Module d'angle avec 1 étagère interne Eckschrank mit 1 Einlegeboden Módulo angular con estante interior</p>	0,4 33	MA	€ 467,00
L 730 x P 730 x H 700 mm				
	<p>Modulare lavello angolare con piano in laminato con vasca inox e miscelatore</p> <p>Corner sink unit with laminate-top, stainless steel bowl and mixer Module évier d'angle avec desus en laminé, cuve et mitigeur Waschbeckeneckschrank mit Laminarbeitsplatte, Edelstahlwaschbecken end Wasserhahn. Modulo lavabo angular con tablero de laminado con casco de acero y grifo</p>	0,4 34	MAL	€ 532,00
L 730 x P 730 x H 700 mm				
	<p>Aspirazione da appoggio per pulitrice completa di illuminazione</p> <p>Suction unit for polisher, with light Aspiration d'appui pour nettoyeuse, complète d'éclairage Absaugbox für Poliermotor, mit Licht Aspiración de apoyo para pulidora, con iluminación</p>	0,2 40	AAP	€ 3.616,00
L 700 x P 550 x H 535 mm				
	<p>Modulare per appoggio fresatore con piano in laminato grigio e boccola passacavo con chiusura, 2 cassetti H 230 (con guide ammortizzate) e 1 tamponamento + 2 antine. Completo di basamento H 170</p> <p>Modular item for router support with gray laminate top and cable gland bush with closure, 2 H 230 drawers (with cushioned guides) and 1 infill + 2 doors. Complete with H 170 base Modulaire pour appui fraiseuse avec plan en laminé gris et douille passe-câbles avec fermeture, 2 tiroirs H 230 (avec glissières amorties) et 1 cache de fermeture + 2 portillons. Muni d'un socle H 170 Modular für Fräsenaufsatz mit Auflage aus grauem Laminat und Kabelführungsbuchse mit Verschluss, 2 Schubladen H 230 (mit gefederten Führungen) und 1 Puffer + 2 kleinen Türen. Versehen mit Sockel H 170 Mueble modular para soporte de fresadora con encimera de laminado gris y casquillo pasacables con cierre, 2 cajones H 230 (con guías amortiguadas) y 1 elemento de relleno + 2 puertas. Con base H 170</p>	- -	M23	€ 1.948,00
L 700 x P 1000 x H 1060 mm				

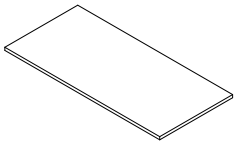
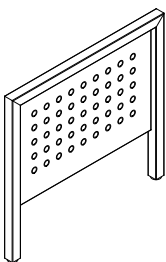
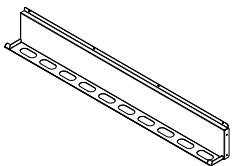
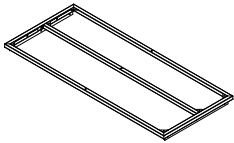
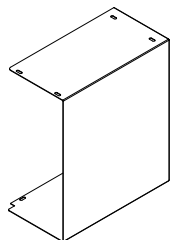
	Descrizione / Description Description / Beschreibung / Descripción	M ³ Kg	Articolo Item / Article Artikel / Artículo	Prezzo Price / Prix Preis / Precio
	<p>Piano in laminato grigio bordato PVC: al metro lineare</p> <p>Grey laminate-surfaced. PVC edged top: per meter Plan en laminé gris avec bord en PVC: au mètre Grau Laminatarbeitsplatte mit PVCkante: je Meter Tablero de laminado gris con borde de PVC: al m.</p>	- 11	PLMW	€ 225,00
P 800 x H 30 mm				
	<p>Supporto laterale dx o sx</p> <p>Lateral support Support lateral Seitenwand für Soporte lateral</p>	- 9	(SX) MW01	€ 142,00
L 740 x P 40 x H 690 mm				
		- 9	(DX) MW02	€ 142,00
	<p>Schiena posteriore: al metro lineare</p> <p>Rear panel: per meter Panneau arrière: au mètre Rückseite: je Meter Panel posterior: al m.</p>	- 5	MW05	€ 46,00
P 170 x H 200 mm				
	<p>Telaio supporto piano: al metro lineare</p> <p>Frame to support the top: per meter Châssis pour soutenir le plan: au mètre Rahmen für Arbeitsplatte: je Meter Frame para apoyar las encimeras: al m.</p>	- 11	MW07	€ 116,00
P 720 x H 30 mm				
	<p>Vano porta PC</p> <p>PC-holder compartment Logement pour unité centrale PC-Fach Compartimento de la PC</p>	- 5	(SX) MW03	€ 85,00
L 218 x P 420 x H 485 mm				
		- 5	(DX) MW04	€ 85,00

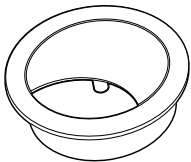
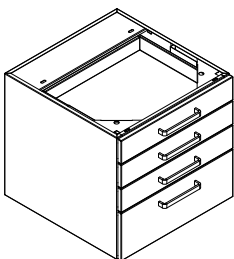
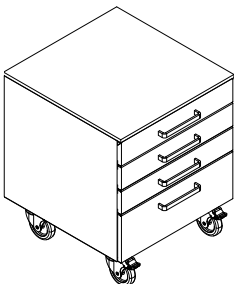
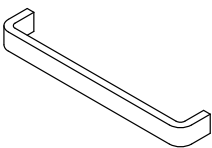
	Descrizione / Description Description / Beschreibung / Descripción	M³ Kg	Articolo Item / Article Artikel / Artículo	Prezzo Price / Prix Preis / Precio
	<p>Boccola passacavo con chiusura - Grigio Alluminio</p> <p>Cable bush with plug - Aluminum Grey Manchon passe-câbles avec fermeture - Gris aluminium Kabeldurchführung mit Verschluss - Aluminiumgrau Casquillo pasacables con cierre - Gris Aluminio</p>	-	BOPM	€ 30,00
Ø 60 mm		-		
	<p>Modulare completo di 4 cassetti</p> <p>Unit with 4 drawers Module avec 4 tiroirs Schrank mit 4 Schubladen Módulo con 4 cajones</p>	0,1 31	MW06	€ 525,00
L 500 x P 518 x H 468 mm				
	<p>Modulare completo di 4 cassetti con Kit ruote + Piano stratificato</p> <p>Modular item complete with 4 drawers with wheels kit + Laminated top Modulaire doté de 4 tiroirs avec Kit roulettes + Plan stratifié Modular mit 4 Schubladen mit Räderbausatz + Verbundplatte Mueble modular con 4 cajones y Kit de ruedas + Encimera estratificada</p>	0,1 15	MW08	€ 798,00
L 730 x P 518 x H 609 mm				
	<p>Supplemento Maniglia Maestro alluminio anodizzato</p> <p>Extra charge for Maestro anodized aluminum handle Supplément Poignée Maestro en aluminium anodisé BeigabeGriff Maestro aus eloxiertem Aluminium Cargo extra Tirador Maestro aluminio anodizado</p>	-	Interasse Wheelbase Entraxe / Abstand Distancia entre ejes	€ +13,00
		-	Interasse Wheelbase Entraxe / Abstand Distancia entre ejes	€ +13,00
		-		

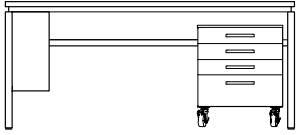
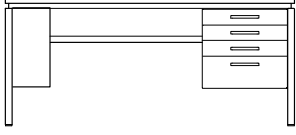
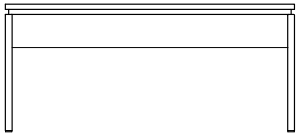
	Descrizione / Description Description / Beschreibung / Descripción	M ³ Kg	Articolo Item / Article Artikel / Artículo	Prezzo Price / Prix Preis / Precio
	<p>Composizione MAESTROWORK con fusto cassetti su ruote e porta PC</p> <p>MAESTROWORK Composition with drawers on wheels and PC holder</p> <p>Composition MAESTROWORK avec bloc-tiroirs sur roulettes et porte PC</p> <p>Komposition MAESTROWORK mit Schubladensockel auf Rädern und PC-Tür</p> <p>Composición MAESTROWORK con cuerpo cajones sobre ruedas y porta PC</p>	- 115	A	€ 1.925,00
	<p>Composizione MAESTROWORK con fusto sospeso e porta PC</p> <p>MAESTROWORK Composition with suspended drawers and PC holder</p> <p>Composition MAESTROWORK avec bloc suspendu et porte PC</p> <p>Komposition MAESTROWORK mit Hängesockel und PC-Tür</p> <p>Composición MAESTROWORK con cuerpo colgante y porta PC</p>	- 100	B	€ 1.653,00
	<p>Composizione semplice con piano e supporti laterali</p> <p>Simple MAESTROWORK Composition with top and side supports</p> <p>Composition MAESTROWORK simple avec plan et supports latéraux</p> <p>Einfache Komposition MAESTROWORK mit Ebene du seitlichen Stützen</p> <p>Composición MAESTROWORK simple con encimera y soportes laterales</p>	- 65	C	€ 956,00

L 1700 x P 800 x H 750 mm

L 1700 x P 800 x H 750 mm

L 1700 x P 800 x H 750 mm

VELA

LOOK

LIKE

ALA/QUADRO
NOVO/UPRIGHT

MOVINGTRAY
MOVING ARM

PURA
PURASTUDIO

STERIL K

CART

ARMADI

BACINELLE

PIANI
ALZATINE

LAVELLI
RUBINETTI



LAVORAZIONI
ACCESSORI

OPEN BOX
SEGGIOLINI

PROF

MAESTRO

IMPIANTISTICA

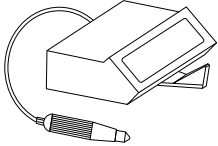
	Descrizione / Description Description / Beschreibung / Descripción	M³ Kg	Articolo Item / Article Artikel / Artículo	Prezzo Price / Prix Preis / Precio
 <p>MAESTROBOX completo di aspirazione con motore a spazzola complete with suction with brush motor complet d'aspiration avec moteur à balais komplett mit Absaugung, variable Saugleistung completo de aspiración con el motor del cepillo</p> <p>L 900 x P 645 x H 1190 mm</p>		- 70	MBOX0A + A1F	€ 4.304,00
 <p>MAESTROBOX predisposto per aspirazione with predisposition for suction system avec prédisposition pour système d'aspiration bereit zum Anschluss einer Absaugung preajuste para el equipo de aspiración</p> <p>L 900 x P 645 x H 1190</p>		- 55	MBOX0B	€ 3.044,00
 <p>Supporto con 4 bacinelle portalavori Support with 4 basins for workpieces Support avec 4 bassinets porte travail Regalschienensystem mit 4 arbeitschalen Soporte con 4 bandejas portatrabajo</p>		- -	SBM+BPL	€ 149,00
 <p>Micromotore con alimentatore a pedale Micromotor with pedal control Micromoteur complet avec alimentation à pédale Mikromotor mit Pedalbedienung Micromotor con alimentador de pedal</p>		- 3,5	MM	€ 1.113,00

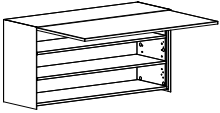
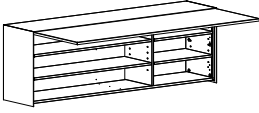
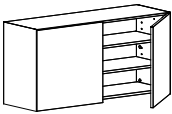
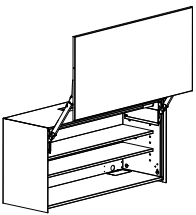
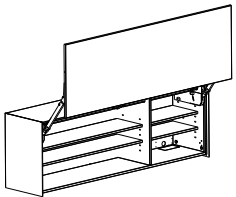
	Descrizione / Description Description / Beschreibung / Descripción	Fianchi Sides / Côtés Seiten / Laterales	M³ Kg	Articolo Item / Article Artikel/Artículo	Prezzo Price / Prix Preis / Precio
 <p>L 1006 x P 350 x H 500 mm</p>	<p>PENSILE L 1006 mm con anta a ribalta verniciata o in vetro, con 2 ripiani interni</p> <p>Wall unit L 1006 mm with flap painted or glass door, with 2 inner shelves</p> <p>Élément haut L 1006 mm avec porte battante peinte ou en verre, avec 2 étagères intérieures</p> <p>Hängeschrank L 1006 mm mit lackierter Kipptür oder Glastür und 2 Inneneinlegeböden</p> <p>Mueble colgante L 1006 mm con hoja basculante pintada o de vidrio, con 2 estantes internos</p>	<p>Anta verniciata Painted / Verni Lackiert Pintado</p>	<p>0,16 ----- 34,5</p>	PVOA	€ 939,00
		<p>Anta in vetro Glass / Verre Glas / Vidrio</p>	<p>0,16 ----- 34,5</p>	PVOAV	€ 1.210,00
 <p>L 1506 x P 350 x H 500 mm</p>	<p>PENSILE L 1506 mm con anta a ribalta verniciata o in vetro, con 2+2 ripiani interni e divisorio verticale</p> <p>Wall unit L 1506 mm with flap painted or glass door, with 2+2 inner shelves and vertical partition</p> <p>Élément haut L 1506 mm avec porte battante peinte ou en verre, avec 2+2 étagères intérieures et séparation verticale</p> <p>Hängeschrank L 1506 mm mit lackierter Kipptür oder Glastür, 2+2 Inneneinlegeböden und senkrechtem Trennelement</p> <p>Mueble colgante L 1506 mm con hoja basculante pintada o de vidrio, con 2+2 estantes internos y separador vertical</p>	<p>Anta verniciata Painted / Verni Lackiert Pintado</p>	<p>0,25 ----- 63,5</p>	PVOB	€ 1.228,00
		<p>Anta in vetro Glass / Verre Glas / Vidrio</p>	<p>0,25 ----- 63,5</p>	PVOBV	€ 1.594,00
 <p>L 1006 x P 350 x H 500 mm</p>	<p>PENSILE L 1006 mm con 2 ante battenti e 2 ripiani interni</p> <p>Cupboard L 1006 mm with 2 doors and 2 internal shelves</p> <p>Élément mural L 1006 mm avec 2 portes battantes et 2 étagères intérieures</p> <p>Hängeschrank L 1006 mm mit 2 Türflügeln und 2 Inneneinlegeböden</p> <p>Mueble colgante L 1006 mm con 2 hojas batientes y 2 estantes interiores</p>	<p>Verniciato Painted / Verni Lackiert Pintado</p>	<p>0,25 ----- 34</p>	PVOC	€ 788,00
 <p>L 1006 x P 350 x H 500 mm</p>	<p>PENSILE L 1006 mm con anta apertura verticale verniciata, con 2 ripiani interni</p> <p>Wall unit L 1006 mm with painted vertical opening door, with 2 internal shelves</p> <p>Élément haut L 1006 mm avec porte ouverture vertical peinte, avec 2 étagères intérieures</p> <p>Hängeschrank L 1006 mm mit lackierter vertikaler Tür, mit 2 Innenregalen</p> <p>Mueble colgante L 1006 mm con puerta de apertura vertical pintada, con 2 estantes interiores</p>	<p>Anta verniciata Painted / Verni Lackiert Pintado</p>	<p>0,25 ----- 52</p>	PVOG	€ 1.135,00
		<p>Anta verniciata Painted / Verni Lackiert Pintado</p>	<p>0,25 ----- 70</p>	PVOI	€ 1.481,00
 <p>L 1506 x P 350 x H 500 mm</p>	<p>PENSILE L 1506 mm con anta apertura verticale verniciata, con 2+2 ripiani interni e divisorio verticale</p> <p>Wall unit L 1506 mm with painted vertical opening door, with 2+2 inner shelves and vertical partition</p> <p>Élément haut L 1506 mm avec porte ouverture vertical peinte, avec 2+2 étagères intérieures et séparation verticale</p> <p>Hängeschrank L 1506 mm mit lackierter vertikaler Tür, 2+2 Inneneinlegeböden und senkrechtem Trennelement</p> <p>Mueble colgante L 1506 mm con puerta de apertura vertical pintada, con 2+2 estantes internos y separador vertical</p>	<p>Anta verniciata Painted / Verni Lackiert Pintado</p>	<p>0,25 ----- 70</p>	PVOI	€ 1.481,00
		<p>Anta verniciata Painted / Verni Lackiert Pintado</p>	<p>0,25 ----- 70</p>	PVOI	€ 1.481,00

VELA

LOOK

LIKE

ALA/QUADRO
NOVO/UPRIGHTMOVINGTRAY
MOVING ARMPURA
PURASTUDIO

STERIL K

CART

ARMADI



BACINELLE

PIANI
ALZATINELAVELLI
RUBINETTILAVORAZIONI
ACCESSORIOPEN BOX
SEGGIOLINI

PROF

MAESTRO

IMPIANTISTICA

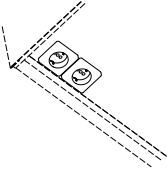
	Descrizione / Description Description / Beschreibung / Descripción	M³ Kg	Articolo Item / Article Artikel/Artículo	Prezzo Price / Prix Preis / Precio
	<p>LAMPADA A LED sottopensile/sottomensola con interruttore touch</p> <p>Under-floor/-shelf LED lamp with touch switch</p> <p>Lampe à LED sous élément haut/sous étagère avec interrupteur tactile</p> <p>LED-lampe für Unterbau Hängeschrank/Regal mit Touch-Schalter</p> <p>Lámpara de LED debajo del mueble colgante/estante con interruptor táctil</p>	-	PLEDE10	<p>€ 201,00</p>
		-	Fino a / Up to L = 1000 mm	
	<p>LAMPADA A LED interna al pensile</p> <p>LED lamp inside the wall unit</p> <p>Lampe à LED à l'intérieur de l'élément haut</p> <p>LED-lampe Hängeschrankinnenseite</p> <p>Lámpara de LED incorporada dentro del mueble colgante</p>	-	PLEDI10	<p>€ 261,00</p>
		-	Fino a / Up to L = 1000 mm	
	<p>Coppia di prese di corrente schuko sotto al pensile</p> <p>Pair of Schuko power outlets under the wall unit</p> <p>Deux prises de courant Schuko sous l'élément haut</p> <p>1 Paar Schuko-Stromsteckdosen unter Hängeschrank</p> <p>Par de tomas de corriente schuko debajo del mueble colgante</p>	-	PAP04	<p>€ 73,00</p>
		-	L = da / from 1000 mm a / to 1500 mm	

MAESTRO | Supporti per mobili serie "S"

Supports for units range "S" / Support pour modules série "S"

Gestellen für Schränke Linie "S" / Soporte par módulos modelo "S"

LORAN

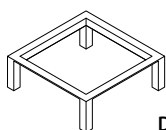
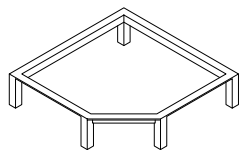

Da L. 500 a L. 1200

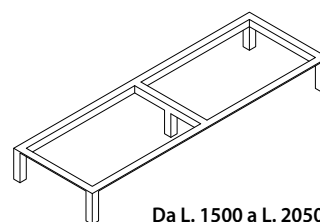

Da L. 1500 a L. 2050

	Descrizione / Description Description / Beschreibung / Descripción	M³ Kg	Articolo Item / Article Artikel / Artículo	Prezzo Price / Prix Preis / Precio
L 735 x P 735 x H 170 mm	Supporto angolare con piedini Corner support with feet Support d'angle avec pieds Eckgestell mit Füßen Soporte angular con patas	0,09 5,5	MSA	€ 173,00
L 500 x P 500 x H 170 mm	Supporto con piedini L.500 Support with feet L.500 Support avec pieds L.500 Gestell mit Füßen L.500 Soporte con patas L.500	0,04 5	MS050	€ 137,00
L 1000 x P 500 x H 170 mm	Supporto con piedini L.1000 Support with feet L.1000 Support avec pieds L.1000 Gestell mit Füßen L.1000 Soporte con patas L.1000	0,09 6	MS100	€ 160,00
L 1050 x P 500 x H 170 mm	Supporto con piedini L.1050 Support with feet L.1050 Support avec pieds L.1050 Gestell mit Füßen L.1050 Soporte con patas L.1050	0,09 6,5	MS105	€ 164,00
L 1200 x P 500 x H 170 mm	Supporto con piedini L.1200 Support with feet L.1200 Support avec pieds L.1200 Gestell mit Füßen L.1200 Soporte con patas L.1200	0,10 7,5	MS120	€ 174,00
L 1500 x P 500 x H 170 mm	Supporto con piedini L.1500 Support with feet L.1500 Support avec pieds L.1500 Gestell mit Füßen L.1500 Soporte con patas L.1500	0,13 8	MS150	€ 227,00

MAESTRO | Supporti per mobili serie "S"

Supports for units range "S" / Support pour modules série "S"

Gestellen für Schränke Linie "S" / Soporte par módulos modelo "S"

LORAN

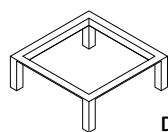

Da L. 500 a L. 1200

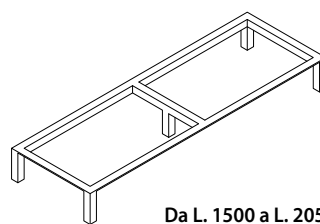

Da L. 1500 a L. 2050

	Descrizione / Description Description / Beschreibung / Descripción	M³ Kg	Articolo Item / Article Artikel / Artículo	Prezzo Price / Prix Preis / Precio
L 1550 x P 500 x H 170 mm	Supporto con piedini L.1550 Support with feet L.1550 Support avec pieds L.1550 Gestell mit Füßen L.1550 Soporte con patas L.1550	0,13 <hr/> 8,5	MS155	€ 231,00
L 2000 x P 500 x H 170 mm	Supporto con piedini L.2000 Support with feet L.2000 Support avec pieds L.2000 Gestell mit Füßen L.2000 Soporte con patas L.2000	0,17 <hr/> 11	MS200	€ 287,00
L 2050 x P 500 x H 170 mm	Supporto con piedini L.2050 Support with feet L.2050 Support avec pieds L.2050 Gestell mit Füßen L.2050 Soporte con patas L.2050	0,17 <hr/> 11,5	MS205	€ 297,00

VELA

LOOK

LIKE

ALA / QUADRO
NOVO / UPRIGHTMOVINGTRAY
MOVING ARMPURA
PURASTUDIO

STERIL K

CART

ARMADI

BACINELLE

PIANI
ALZATINELAVELLI
RUBINETTILAVORAZIONI
ACCESSORIOPEN BOX
SEGGIOLINI

PROF

MAESTRO

IMPIANTISTICA

MAESTRO | Basamenti per mobili serie "B"

Base for units range "B" / Bases pour modules série "B"

Sockel für Schränke Linie "B" / Bases par módulos modelo "B"

LORAN

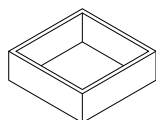
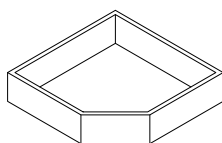

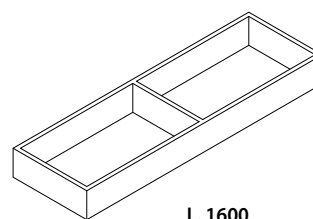

Da L. 500 a L. 1200



L. 1600

	Descrizione / Description Description / Beschreibung / Descripción	M³ Kg	Articolo Item / Article Artikel / Artículo	Prezzo Price / Prix Preis / Precio
L 735 x P 735 x H 170 mm	Basamento angolare Corner base unit Base d'angle Ecksockel Base Angular	0,09 4	MBA	€ 68,00
L 500 x P 500 x H 170 mm	Basamento L.500 Base unit L.500 Base L.500 Sockel L.500 Base L.500	0,04 3	MB01	€ 45,00
L 1000 x P 500 x H 170 mm	Basamento L.1000 Base unit L.1000 Base L.1000 Sockel L.1000 Base L.1000	0,09 5,5	MB02	€ 66,00
L 1050 x P 500 x H 170 mm	Basamento L.1050 Base unit L.1050 Base L.1050 Sockel L.1050 Base L.1050	0,09 6	MB03	€ 68,00
L 1200 x P 500 x H 170 mm	Basamento L.1200 Base unit L.1200 Base L.1200 Sockel L.1200 Base L.1200	0,10 7,5	MB04	€ 73,00
L 1600 x P 500 x H 170 mm	Basamento L.1600 Base unit L.1600 Base L.1600 Sockel L.1600 Base L.1600	0,14 10	MB05	€ 87,00

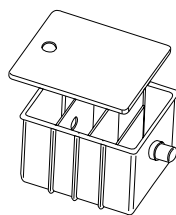
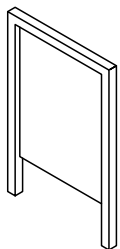
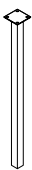
	Descrizione / Description Description / Beschreibung / Descripción	M³ Kg	Articolo Item / Article Artikel / Artículo	Prezzo Price / Prix Preis / Precio
	<p>Decantatore cilindrico con sacchetto per il recupero del materiale decantato</p> <p>Cylinder-shaped decanter, with collection bag Décanteur cylindrique avec sachet pour la récupération du matériel décanté Zylinderförmiger Gipsabscheider mit Beutel zum Auffangen des abgeschiedenen Materials Decantador cilíndrico con saco para la recuperación del material decantado</p>	- 2,5	DEB	€ 565,00
L ø 340 x P ---- x H 300 mm				
	<p>Confezione con n° 25 sacchetti per decantatore DEB</p> <p>Pack of 25 sacks for decanter DEB Confection de n° 25 sachets pour décanteur DEB N. 25 Müllsacks für Gipsabscheider DEB Paquete con 25 sacos para el decantador DEB</p>	- 1	SAD	€ 38,00
	<p>Decantatore in ABS</p> <p>ABS decanter Bac de decantation en ABS Gipsabscheider aus ABS Decantador en ABS</p>	- 2,6	DEP	€ 443,00
L 320 x P 430 x H 270 mm				
	<p>Supporto laterale mobili</p> <p>Lateral support for units Support lateral pour modules Seitenwand für Schränke Soporte lateral para módulos</p>	- 10	MCLM	€ 148,00
L 540 x P 40 x H 870 mm				
	<p>Supporto di sostegno in tubolare singolo per piano</p> <p>Single tube shelf bracket Support en tube simple pour plan de travail Stützvorrichtung aus einfachem Rohr für Arbeitsplatte Soporte de sostén en tubular para la encimera</p>	- 8	MSTS	€ 122,00
L 40 x P 40 x H 870 mm				

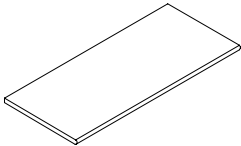
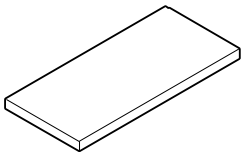
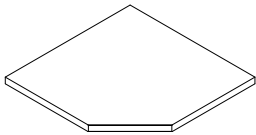
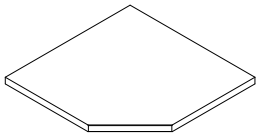
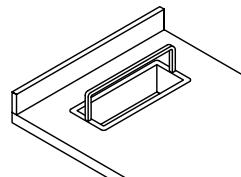
	Descrizione / Description Description / Beschreibung / Descripción	M ³ Kg	Articolo Item / Article Artikel / Artículo	Prezzo Price / Prix Preis / Precio
	<p>Piano in laminato grigio bordato PVC al metro lineare</p> <p>Grey laminate-surfaced. PVC edged top: per meter Plan en laminé gris avec bord en PVC: au mètre Grau Laminarbeitsplatte mit PVCkante: je Meter Tablero de laminado gris con borde de PVC: al m.</p>	- 12	PLM	€ 200,00
L a misura x P 600 x H 30 mm				
	<p>Piano in acciaio inox al metro lineare</p> <p>Stainless steel top: per meter Dessus en acier inox: au mètre Edelstahlarbeitsplatte: je meter Tablero de acero inoxidable: al m.</p>	- 21	ID	€ 681,00
L a misura x P 600 x H 30 mm				
	<p>Piano angolare in laminato</p> <p>Laminate top for corner units Plan en laminé pour modules d'angles Weiße Laminarbeitsplatte für Eckschränke Encimera de laminado para módulos angulares</p>	- -	PLMA	€ 322,00
L 791 x P 791 x H 30 mm				
	<p>Piano angolare in acciaio inox</p> <p>Stainless steel corner top Plan angulaire en acier inox Eckplatte aus Edelstahl Encimera angular de acero inoxidable</p>	- -	IDAM	€ 1.180,00
L 791 x P 791 x H 30 mm				
	<p>Foro gesso su piano laminato inox</p> <p>Hole for plaster waste on laminate / stainless steel Trou plâtre sur plan laminé / inox Gipsloch auf laminiertes Platte auf Edelstahlplatte Agujero escayola en encimera laminada acero inoxidable</p>	- -	FGL laminato	€ 68,00
		- -	FGI inox	€ 331,00

VELA

LOOK

LIKE

ALA/QUADRO
NOVO/UPRIGHTMOVINGTRAY
MOVING ARMPJURA
PURASTUDIO

STERIL K

CART

ARMADI

BACINELLE

PIANI
ALZATINELAVELLI
RUBINETTILAVORAZIONI
ACCESSORIOPEN BOX
SEGGIOLINI

PROF



MAESTRO

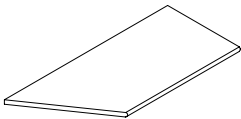
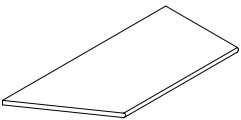
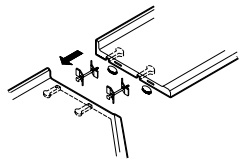

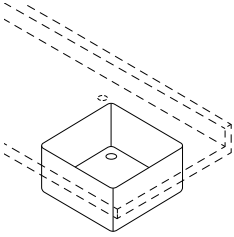
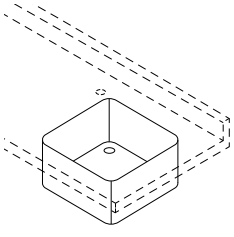
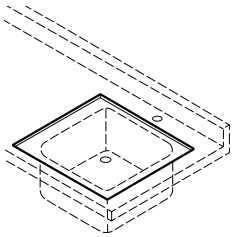
IMPIANTISTICA

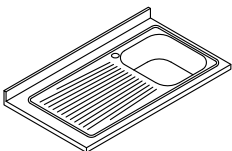
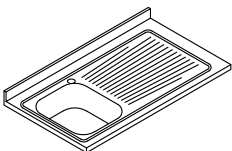
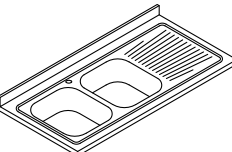
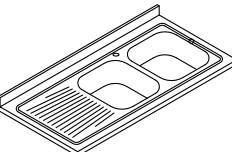

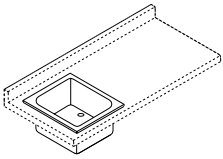
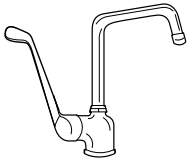
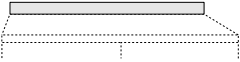
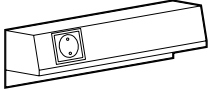
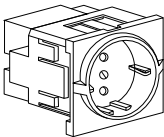

	Descrizione / Description Description / Beschreibung / Descripción	M³ Kg	Articolo Item / Article Artikel / Artículo	Prezzo Price / Prix Preis / Precio
	<p>Taglio obliquo su piano laminato</p> <p>Oblique cut of laminate-surfaced top Découpe oblique sur le plan de travail en laminé Schrägschnitt der Laminarbeitsplatte Corte oblicuo sobre la encimera de laminado</p>	- -	TSP	€ 95,00
	<p>Taglio obliquo su piano inox</p> <p>Oblique cut of stainless steel top Découpe oblique sur le plan de travail en acier inox Schrägschnitt der Edelstahl-arbeitsplatte Corte oblicuo sobre la encimera de acero inoxidable</p>	- -	TSI	€ 361,00
	<p>Set collegamento 2 piani laminato inox</p> <p>Work-top connection set for laminate stainless steel top Set pour la liaison de 2 plans de travail en laminé acier inox Set für Zusammenbau von Laminarbeitsplatten Edelstahl-arbeitsplatte Juego para la unión de las 2 encimeras de laminado acero inoxidable</p>	- -	SCP laminato	€ 60,00
		- -	SCI inox	€ 165,00

	Descrizione / Description Description / Beschreibung / Descripción	M³ Kg	Articolo Item / Article Artikel / Artículo	Prezzo Price / Prix Preis / Precio
 <p>Lavello in acciaio inox con angoli interni di raggio 10 mm incorporato al piano inox</p> <p>Stainless steel sink with 10 mm radius internal corners incorporated into the stainless steel top</p> <p>Évier en acier inox avec angles internes de 10 mm de rayon incorporé au plan en inox</p> <p>Waschbecken aus Edelstahl mit Innenecken (10 mm Radius), eingebaut in die Edelstahlplatte</p> <p>Lavabo de acero inoxidable con esquinas internas, radio 10 mm, incorporado en la encimera de acero inoxidable</p> <p>L 400 x P 400 x H 200 mm</p>		- 5	V1P	€ 883,00
 <p>Lavello in acciaio inox con angoli interni di raggio 30 mm incorporato al piano inox</p> <p>Stainless steel sink with 30 mm radius internal corners incorporated into the stainless steel top</p> <p>Évier en acier inox avec angles internes de 30 mm de rayon incorporé au plan en inox</p> <p>Waschbecken aus Edelstahl mit Innenecken (30 mm Radius), eingebaut in die Edelstahlplatte</p> <p>Lavabo de acero inoxidable con esquinas internas, radio 30 mm, incorporado en la encimera de acero inoxidable</p> <p>L 400 x P 340 x H 200 mm</p>		- 5	V1I	€ 594,00
 <p>Abbassamento per lavello in acciaio inox incorporato al piano, al metro lineare</p> <p>Lowered element for stainless steel sink incorporated into the top, per meter</p> <p>Abaissement pour évier en acier incorporé au plan, au mètre</p> <p>Vertiefung für in die Ebene eingebautes Edelstahl-Waschbecken, je Meter</p> <p>Bajada para lavabo de acero inoxidable incorporado en la encimera, al m.</p>		- -	VAA	€ 213,00

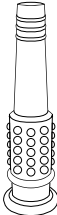
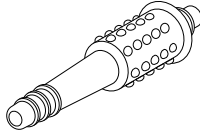
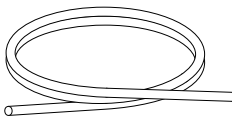
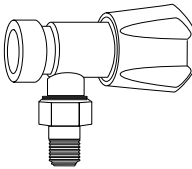
	Descrizione / Description Description / Beschreibung / Descripción	M³ Kg	Articolo Item / Article Artikel / Artículo	Prezzo Price / Prix Preis / Precio
	<p>Lavello da appoggio per M14 (DX)</p> <p>Free standing sink for M14 (DX) Évier à poser pour M14 (DX) Aufsatzwaschbecken für M14 (DX) Fregadero de sobremesa para M14 (DX)</p>	-	LAV19	€ 406,00
L 1050 x P 600 x H 90 mm		-		
	<p>Lavello da appoggio per M14 (SX)</p> <p>Free standing sink for M14 (SX) Évier à poser pour M14 (SX) Aufsatzwaschbecken für M14 (SX) Fregadero de sobremesa para M14 (SX)</p>	-	LAV18	€ 406,00
L 1050 x P 600 x H 90 mm		-		
	<p>Lavello da appoggio per M16 (SX)</p> <p>Free standing sink for M16 (SX) Évier à poser pour M16 (SX) Aufsatzwaschbecken für M16 (SX) Fregadero de sobremesa para M16 (SX)</p>	-	LAV20	€ 467,00
L 1200 x P 600 x H 90 mm		-		
	<p>Lavello da appoggio per M16 (DX)</p> <p>Free standing sink for M16 (DX) Évier à poser pour M16 (DX) Aufsatzwaschbecken für M16 (DX) Fregadero de sobremesa para M16 (DX)</p>	-	LAV21	€ 467,00
L 1200 x P 600 x H 90 mm		-		

	Descrizione / Description Description / Beschreibung / Descripción	M³ Kg	Articolo Item / Article Artikel / Artículo	Prezzo Price / Prix Preis / Precio
	Inserto inox con lavello Stainless steel insert with sink Insert inox avec évier Edelstahleinsatz mit Spüle und Abtropfblech Elemento de Acero inoxidable con lavabo	- 2,5	V2S	€ 335,00
L 360 x P 360 x H 163				
	Rubinetto cromato con collo alto Chromed mixer Mitigeur chromé Verchromte Wasserhahn Grifo cromado	- 1,5	RB4	€ 183,00
	Alzatina inox applicata: al metro lineare Applied stainless steel reartrim: per meter Dossieret appliqué en inox: au mètre Edelstahlaufgeklebter Aufkantung: je meter Elevación aplicado de acero: al m. Minimo fatturabile: 1 metro lineare Minimum charge: 1 meter Base minimale de facturation: 1 mètre Mindestgebühr: 1 meter Minimo facturabile: 1 metro	- 1,3	AIM	€ 46,00
L a misura x P 15 x H 60 mm				
	Canalina tecnica in alluminio anodizzato al metro lineare Aluminium raceway: per meter Canalisation technique en aluminium: je meter Technikkanal aus eloxiertem Aluminium: je Meter Canal técnico de aluminio: al m.	- 1,2	CVE	€ 93,00
L a misura x P 63 x H 75 mm				
	Presa di corrente Schuko montata su canalina tecnica CVE Schuko socket fitted on raceway CVE Prise de courant Schuko montée sur canalisation technique CVE Schuko-Steckdose für Technikkanal CVE Toma de corriente Schuko para canal técnico CVE	- -	PCS	€ 37,00
	Colonna con 3 prese Schuko a scomparsa sul piano Column with 3 Schuko sockets concealable in the worktop Colonne avec 3 prises de courant Schuko escamotables dans le plan de travail Säule mit 3 Schuko-Steckdosen, voll in die Ebene integrierbar Columna con 3 tomas Schuko ocultas en la encimera	- 0,6	CPC	€ 448,00
	Colonna con 3 prese Schuko e 2 prese dati a scomparsa sul piano Column with 2 Schuko sockets and 2 data sockets concealable in the worktop Colonne avec 2 prises de courant Schuko et 2 prises données escamotables dans le plan Säule mit 2 Schuko-Steckdosen und 2 Daten-Buchsen voll in die Ebene integrierbar Columna con 2 tomas Schuko y 2 tomas de datos ocultas en la encimera	- 0,6	CPD	€ 579,00

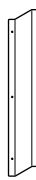
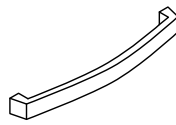
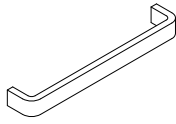
	Descrizione / Description Description / Beschreibung / Descripción	M³ Kg	Articolo Item / Article Artikel / Artículo	Prezzo Price / Prix Preis / Precio
	Attacco rapido aria montato su canalina tecnica CVE Quick air connection fitted on raceway CVE Raccord rapide air monté sur canalisation technique CVE Druckluftanschluß mit Schnellkupplung für Technikkanal CVE Conexión rápida de aire montada sobre el canal técnico CVE	- ----	ARA	€ 69,00
	Riduttore di pressione montato su canalina tecnica CVE Pressure reducer fitted on raceway CVE Réducteur de pression pour l'air, monté sur canalisation technique CVE Druckreduzierer integriert im Technikkanal CVE Reductor de presión montado sobre el canal técnico CVE	- ----	RIP	€ 96,00
	Manometro montato su canalina tecnica CVE Pressure gauge fitted on raceway CVE Manomètre monté sur canalisation technique CVE Druckmanometer für Technikkanal CVE Manómetro montado sobre el canal técnico CVE	- ----	MAN	€ 90,00
	Siringa aria per modulari di servizio, a scomparsa sul piano Hide-away top air syringe for service units Soufflette air pour modules de travail, escamotable sur le plan Versenkbare Luftpüse auf der Arbeitsplatte Jeringa de aire para módulos de servicio escamoteable sobre la encimera	- ----	SAR	€ 103,00
	Siringa aria solo manipolo Air syringe, only holder Soufflette à air, seule pièce à main Luftspritze, nur Handstück Jeringa de aire, solo mando	- ----	PIS04	€ 23,00
	Tubo calzato nero per siringa aria: al metro Black hose for air syringe: price per meter Tuyau revêtu noir pour soufflette à air : au mètre Schwarzer ummantelter Schlauch für Luftspritze: pro Meter Tubo encastrado negro para jeringa de aire, por metro	- ----	TU003	€ 32,00
	Rubinetto per squadramodelli Mixer for trimmer-rack Robinet pour la taille-plâtre Hahn für Trimmer Grifo para el instrumento para el recorte de los moldes de yeso	- ----	RUS	€ 53,00

	Descrizione / Description Description / Beschreibung / Descripción	M³ Kg	Articolo Item / Article Artikel / Artículo	Prezzo Price / Prix Preis / Precio
	Pannello di chiusura da 70 a 150 mm Closing panel from 70 to 150 mm Cache de fermeture de 70 à 150 mm Verschlußverkleidung von 70 bis 150 mm Panel de cierre desde 70 hasta 150 mm	- ----- -	MPC1	€ 43,00
H min 700 mm H max 870 mm				
	Pannello di chiusura da 160 a 250 mm Closing panel from 160 to 250 mm Cache de fermeture de 160 à 250 mm Verschlußverkleidung von 160 bis 250 mm Panel de cierre desde 160 hasta 250 mm	- ----- -	MPC2	€ 58,00
H min 700 mm H max 870 mm				
	Pannello di chiusura da 160 a 250 mm Corner closing panel Cache de fermeture pour angle Eckverschlußverkleidung Panel de cierre en ángulo	- ----- -	MPC3	€ 73,00
H min 700 mm H max 870 mm				
	Maniglia Maestro Handle Maestro Poignée Maestro Griff Maestro Tirador Maestro	Interasse / Wheelbase Entraxe / Abstand Distancia entre ejes 224	- ----- -	MA015 € 5,00
		Interasse / Wheelbase Entraxe / Abstand Distancia entre ejes 160	- ----- -	MA016 € 5,00
	Maniglia Maestro anodizzata Maestro anodized aluminum handle Poignée Maestro en aluminium anodisé Griff Maestro aus eloxiertem Aluminium Tirador Maestro aluminio anodizado	Interasse / Wheelbase Entraxe / Abstand Distancia entre ejes 160	- ----- -	MA017 € 18,00
		Interasse / Wheelbase Entraxe / Abstand Distancia entre ejes 224	- ----- -	MA018 € 18,00
	Confezione con n° 50 sacchi gesso Pack of 50 plaster sacks Confection de n° 50 sacs pour le plâtre Gipssacks (50 Stck.) Paquete con 50 sacos de yeso	- ----- -	SAG	€ 100,00
	Sacco filtro in tessuto per AAP Tissue bag for AAP Sac en tissu pour AAP Stoffsack für AAP Saco de tejido para AAP	- ----- -	SFP	€ 82,00

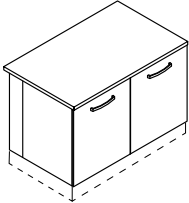
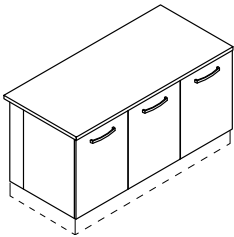
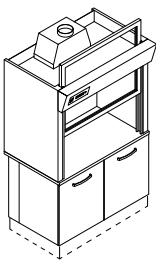
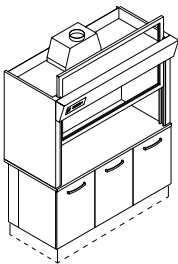
	Descrizione / Description Description / Beschreibung / Descripción	M³ Kg	Articolo Item / Article Artikel / Artículo	Prezzo Price / Prix Preis / Precio
	<p>Base sottocappa con piano inox</p> <p>Hood base with stainless steel top</p> <p>Partie basse pour hotte avec plan de travail inox</p> <p>Basis für Ofenschrank mit Edelstahl-arbeitsplatte</p> <p>Elemento debajo de la campana con encimera de acero inoxidable</p>	0,6 58	MB120	€ 1.887,00
L 1200 x P 740 x H 730 mm				
	<p>Base sottocappa con piano inox</p> <p>Hood base with stainless steel top</p> <p>Partie basse pour hotte avec plan de travail inox</p> <p>Basis für Ofenschrank mit Edelstahl-arbeitsplatte</p> <p>Elemento debajo de la campana con encimera de acero inoxidable</p>	0,9 85	MB160	€ 2.159,00
L 1600 x P 740 x H 730 mm				
	<p>Cappa aspirante</p> <p>Suction hood</p> <p>Hotte aspirante</p> <p>Ofenschrank</p> <p>Campana aspirante</p>	2,0 134	MC120	€ 5.001,00
L 1200 x P 740/840 x H 1954 mm				
	<p>Cappa aspirante</p> <p>Suction hood</p> <p>Hotte aspirante</p> <p>Ofenschrank</p> <p>Campana aspirante</p>	2,6 186	MC160	€ 5.671,00
L 1600 x P 740/840 x H 1954 mm				

MAESTRO | Cappe pensili

Suspended hoods / Hottes muraux

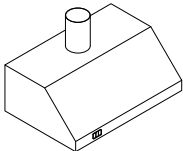
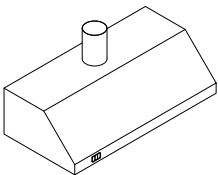

Wand-Ofenschränke / Campanas colgantes

LORAN

	Descrizione / Description Description / Beschreibung / Descripción	M³ Kg	Articolo Item / Article Artikel / Artículo	Prezzo Price / Prix Preis / Precio
	<p>Cappa aspirante pensile inox con filtri in acciaio inox</p> <p>Stainless steel suspended suction hood with a steel filter Hotte aspirante murale inox avec filtre en acier inox Wandabzugshaube aus Edelstahl mit Edelstahlfilter Campana aspirante colgante de acero inoxidable con filtro de acero</p>	0,4 54	CAP120	€ 3.513,00
L 1200 x P 800 x H 450 mm				
	<p>Cappa aspirante pensile inox con filtri in acciaio inox</p> <p>Stainless steel suspended suction hood with a steel filter Hotte aspirante murale inox avec filtre en acier inox Wandabzugshaube aus Edelstahl mit Edelstahlfilter Campana aspirante colgante de acero inoxidable con filtro de acero</p>	0,6 71	CAP160	€ 3.952,00
L 1600 x P 800 x H 450 mm				

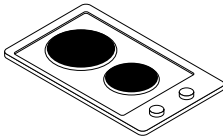
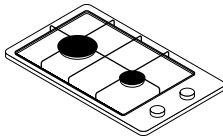
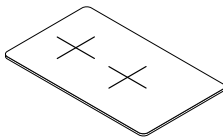
Accessori per cappe Hoods's accessories / Accessoires pour hottes / Zubehörteile für Ofenschränke / Accesorios para campanas

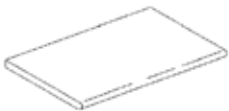
	Descrizione / Description Description / Beschreibung / Descripción	M³ Kg	Articolo Item / Article Artikel / Artículo	Prezzo Price / Prix Preis / Precio
	<p>Inserto coppia piastre elettriche</p> <p>Pair of hot plates Insert avec deux plaques chauffantes Einsatz für zwei Kochplatten Insertable par de placas eléctricas con protección térmica</p>	- 5,5	I2E	€ 496,00
L 300 x P 500 x H 140 mm				
	<p>Inserto coppia fornelli a gas con accensione automatica e valvola di sicurezza</p> <p>Unit with 2 gas stoves with automatic ignition and safety valve Insert avec paire de fourneaux à gaz à allumage automatique et vanne de sûreté Element mit 2 Gaskochern, Sicherheitsventil und automatischem Anzünder Elemento con un par de hornillos de gas con encendido automático y válvula de seguridad</p>	- 5,5	I2G	€ 532,00
L 300 x P 500 x H 140 mm				
	<p>Inserto coppia fornelli a induzione con comandi Touch Control</p> <p>Pair of induction stoves with Touch Control Insert avec deux fourneaux à induction avec commandes Touch Control Einsatz für zwei Induktionkocher mit Touch-Control Insertable par de hornillas de inducción con control táctil</p>	- 5,5	I2I	€ 1.051,00
L 300 x P 500 x H 140 mm				

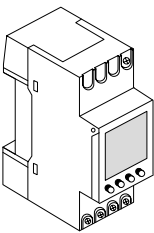
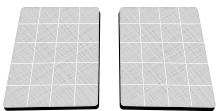
	Descrizione / Description Description / Beschreibung / Descripción	M³ Kg	Articolo Item / Article Artikel / Artículo	Prezzo Price / Prix Preis / Precio
	<p>Mensola porta forno in acciaio inox con supporti</p> <p>Stainless steel oven support Etagère porte-four en inox, complète de supports Edelstahlablage für Muffeln und Lötgut Repisa portahorno de acero inoxidable con soportes</p>	- 12	MPF	€ 799,00
	<p>Pres a e spina di corrente supplementare</p> <p>Additional socket and plug Prise femelle + prise mâle supplémentaires de courant Zusätzliche Steckdose im Ofenschrank Toma y enchufe de corriente adicional</p>	- -	PSC	€ 90,00
	<p>Temporizzatore digitale per accensione aspirazione cappa</p> <p>Digital timer for turning on the suction hood Programmateur pour la mise en marche de l'aspiration de la hotte Digitale Zeitschaltuhr zum Einschalten der Dunstabzugshaube Temporizador digital para el encendido de la aspiración de la campana</p>	- -	TDA	€ 357,00
	<p>Coppia filtri con carboni attivi per cappa</p> <p>Pair of activated carbon filters for hood Deux filtres à charbons actifs pour hotte Zwei Aktivkohlefiltern für Ofenschrank Par de filtros de carbonos activos para campanas</p>	- -	FCA	€ 60,00

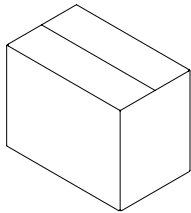
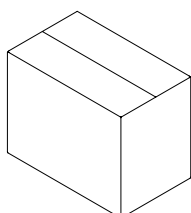
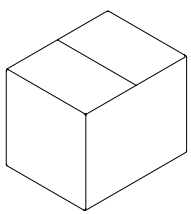
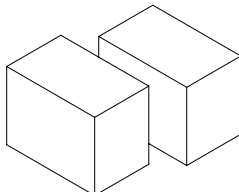
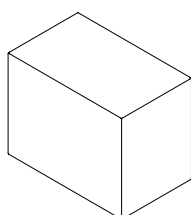
	Descrizione / Description Description / Beschreibung / Descripción	Articolo Item / Article Artikel / Artículo	Prezzo Price / Prix Preis / Precio
	<p>Imballo 1 banco MF1 o MF2 (prezzo netto)</p> <p>Package for 1 table (net price) Emballage pour 1 établi (prix net) Verpackung für 1 Tisch (nettopreis) Embalaje para 1 banco (precio neto)</p>	IM1	€ 80,00
	<p>Imballo 1 banco MF2-CO o MFSD (prezzo netto)</p> <p>Package for 1 table (net price) Emballage pour 1 établi (prix net) Verpackung für 1 Tisch (nettopreis) Embalaje para 1 banco (precio neto)</p>	IM2	€ 115,00
	<p>Imballo 1 modulare e/o altri colli (prezzo netto)</p> <p>Package for 1 unit, other items (net price) Emballage pour 1 module, autres colis (prix net) Verpackung für 1 Schrank, anderes Material (nettopreis) Embalaje módulo, otro material (precio neto)</p>	IM3	€ 55,00
	<p>Imballo 1 cappa (prezzo netto)</p> <p>Boxes for 1 hood (net price) Emballage pour 1 hotte (prix net) Verpackung für 1 Ofenschrank (nettopreis) Embalaje para 1 campana (precio neto)</p>	IM4	€ 170,00
	<p>Spese imballo Maestrobox (prezzo netto)</p> <p>Packing costs Maestrobox (net price) Frais d'emballage Maestrobox (prix net) Verpackungskosten Maestrobox (nettopreis) Embalaje Maestrobox (precio neto)</p>	IM5	€ 80,00

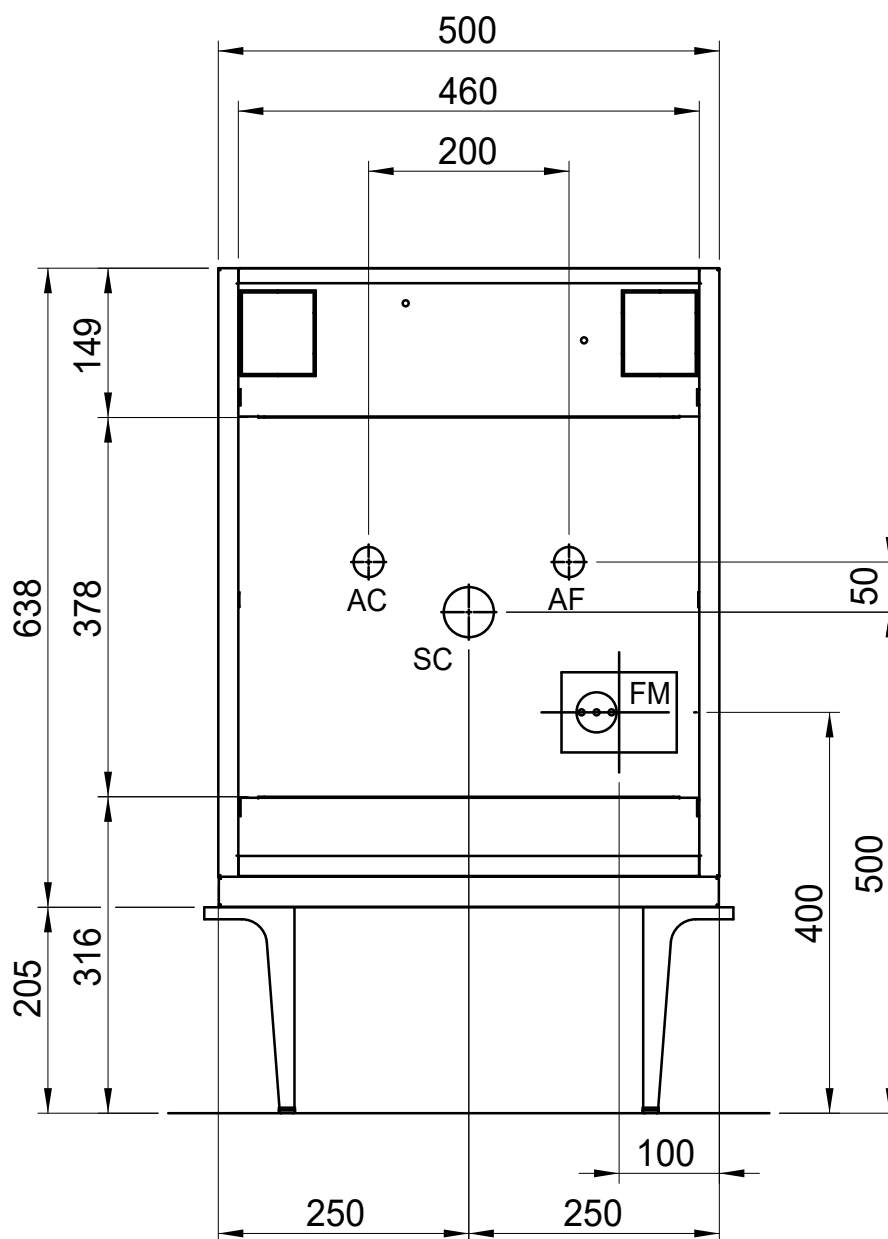

AF

Acqua fredda

Cold water
Eau froide
Kaltwasser
Agua fría

AC

Acqua Calda

Hot water
Eau chaude
Warmwasser
Agua caliente

SC

Scarico

Drainage
Vidange
Abfluss
Desague

FM

Forza elettromotrice

Electrical socket
Prise électrique
Elektrischer Anschluss
Toma eléctrica

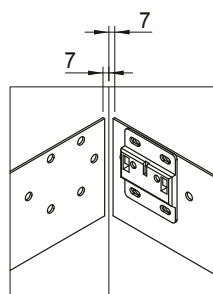
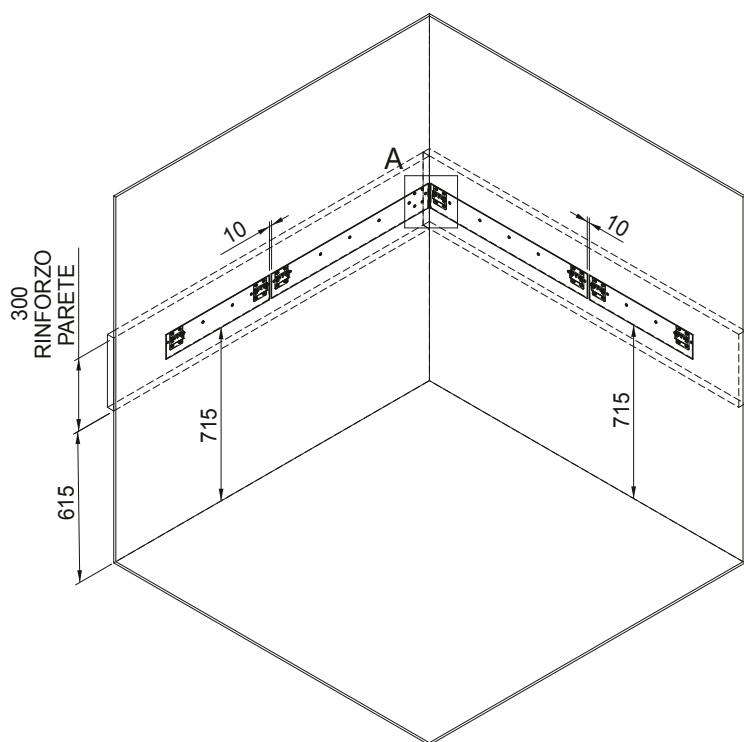

DETTAGLIO A
SCALA 1 : 5

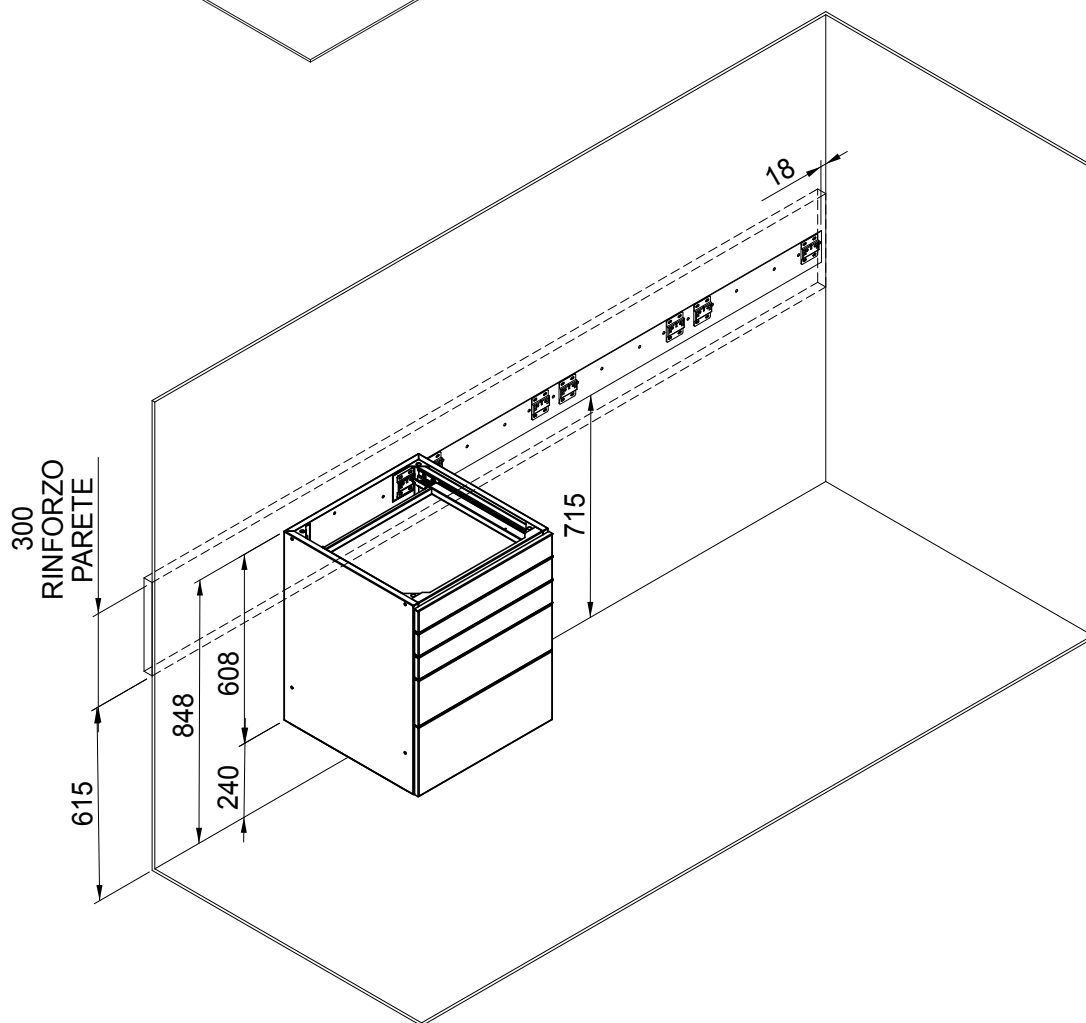

VELA
LOOK
LIKE
ALA/QUADRO NOVO/UPRIGHT
MOVINGTRAY MOVING ARM
PURA PURASTUDIO
STERIL K
CART
ARMADI
BACINELLE
PIANI ALZATINE
LAVELLI RUBINETTI
LAVORAZIONI ACCESSORI
OPEN BOX SEGGIOLINI
PROF
MAESTRO
IMPIANTISTICA

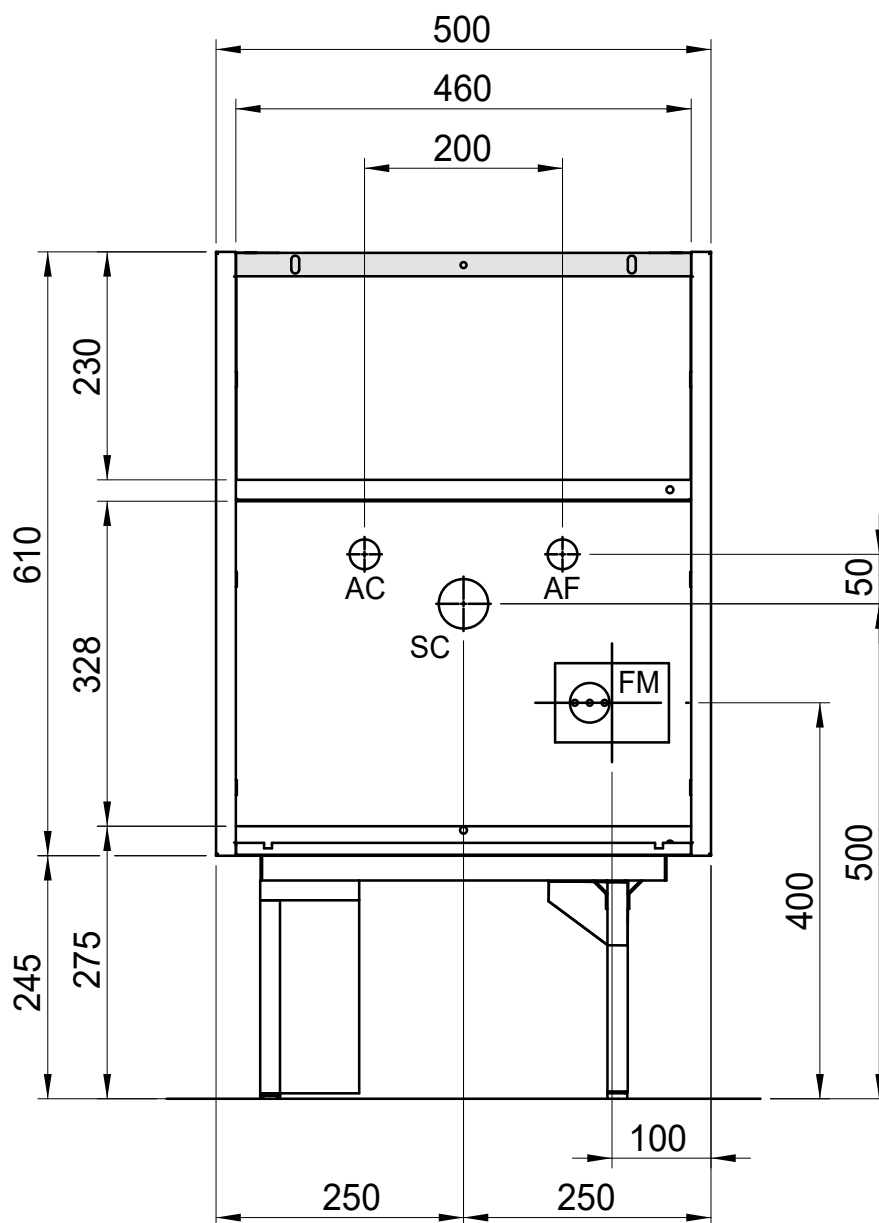

AF

Acqua fredda

Cold water
Eau froide
Kaltwasser
Agua fría

AC

Acqua Calda

Hot water
Eau chaude
Warmwasser
Agua caliente

SC

Scarico

Drainage
Vidange
Abfluss
Desague

FM

Forza elettromotrice

Electrical socket
Prise électrique
Elektrischer Anschluss
Toma eléctrica

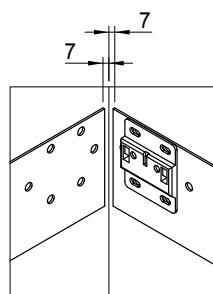
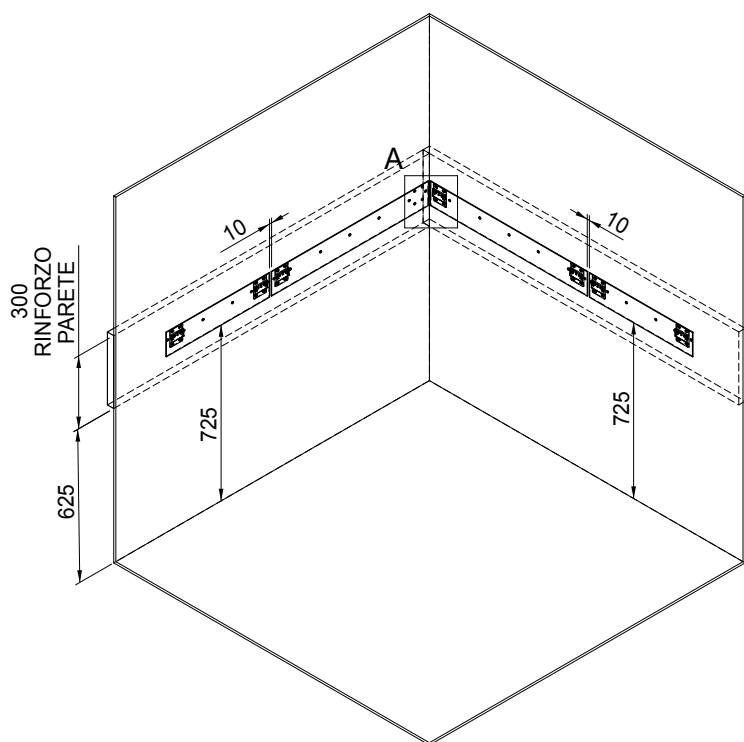

DETTAGLIO A
SCALA 1 : 5

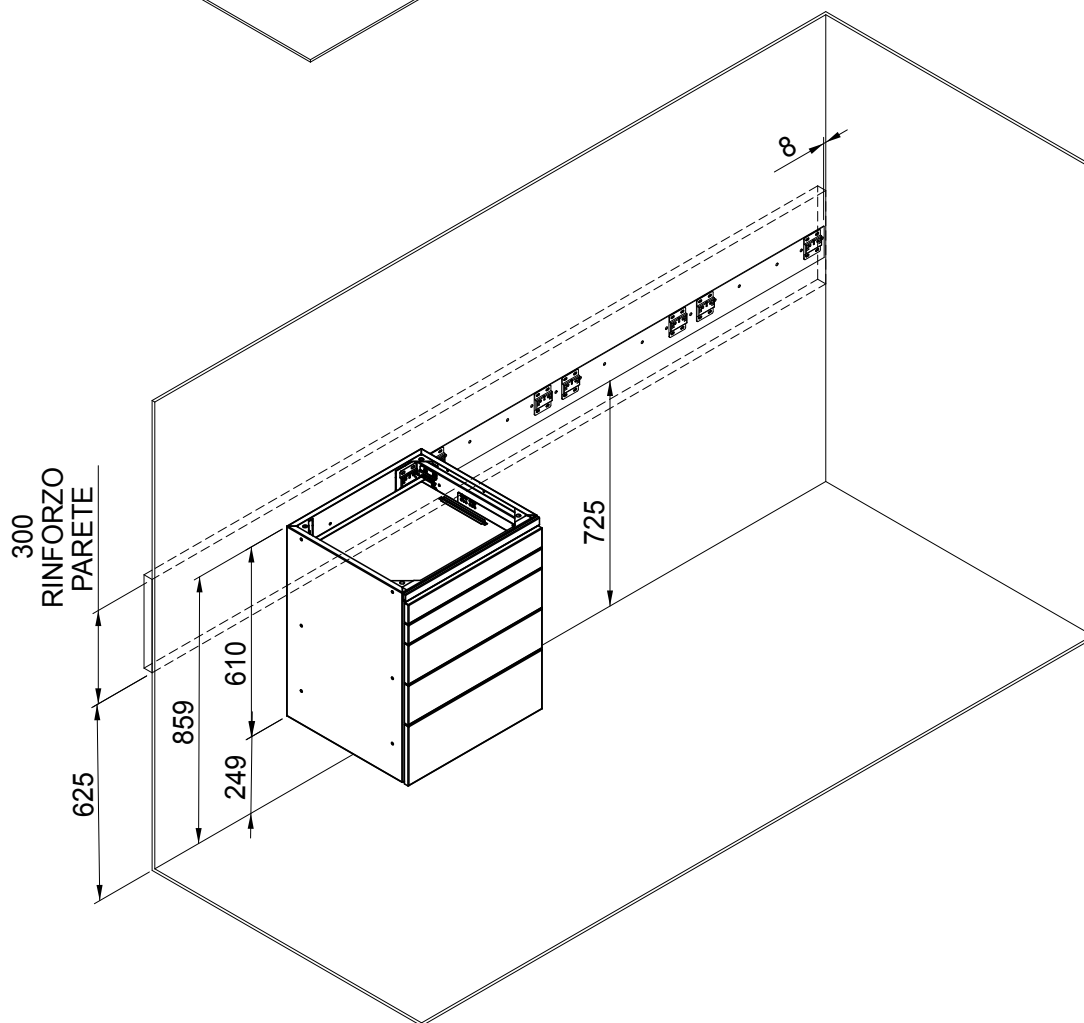

VELA
LOOK
LIKE
ALA/QUADRO NOVO/UPRIGHT
MOVINGTRAY MOVING ARM
PURRA PURASTUDIO
STERIL K
CART
ARMADI
BACINELLE
PIANI ALZATINE
LAVELLI RUBINETTI
LAVORAZIONI ACCESSORI
OPEN BOX SEGGIOLINI
PROF
MAESTRO
IMPIANTISTICA

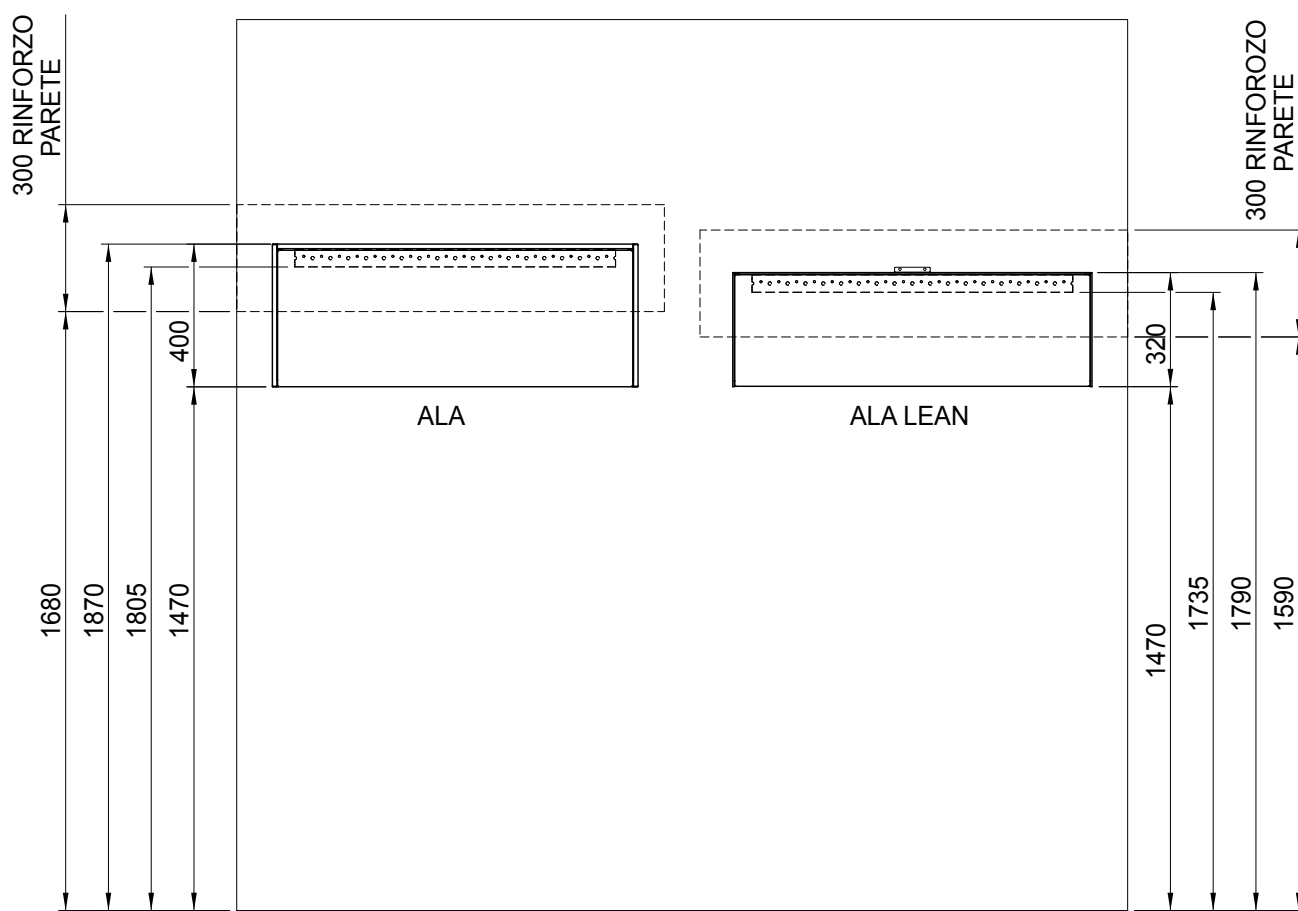

IMPIANTISTICA	MAESTRO	PROF	OPEN BOX SEGGIOLINI	LAVORAZIONI ACCESSORI	LAVELLI RUBINETTI	PIANI ALZATINE	BACINELLE	ARMADI	CART	STERIL K	PURA PURASTUDIO	MOVINGTRAY MOVING ARM	ALA/QUADRO NOVO/UPRIGHT	LIKE	LOOK	VELA
---------------	---------	------	------------------------	--------------------------	----------------------	-------------------	-----------	--------	------	----------	--------------------	--------------------------	----------------------------	------	------	------

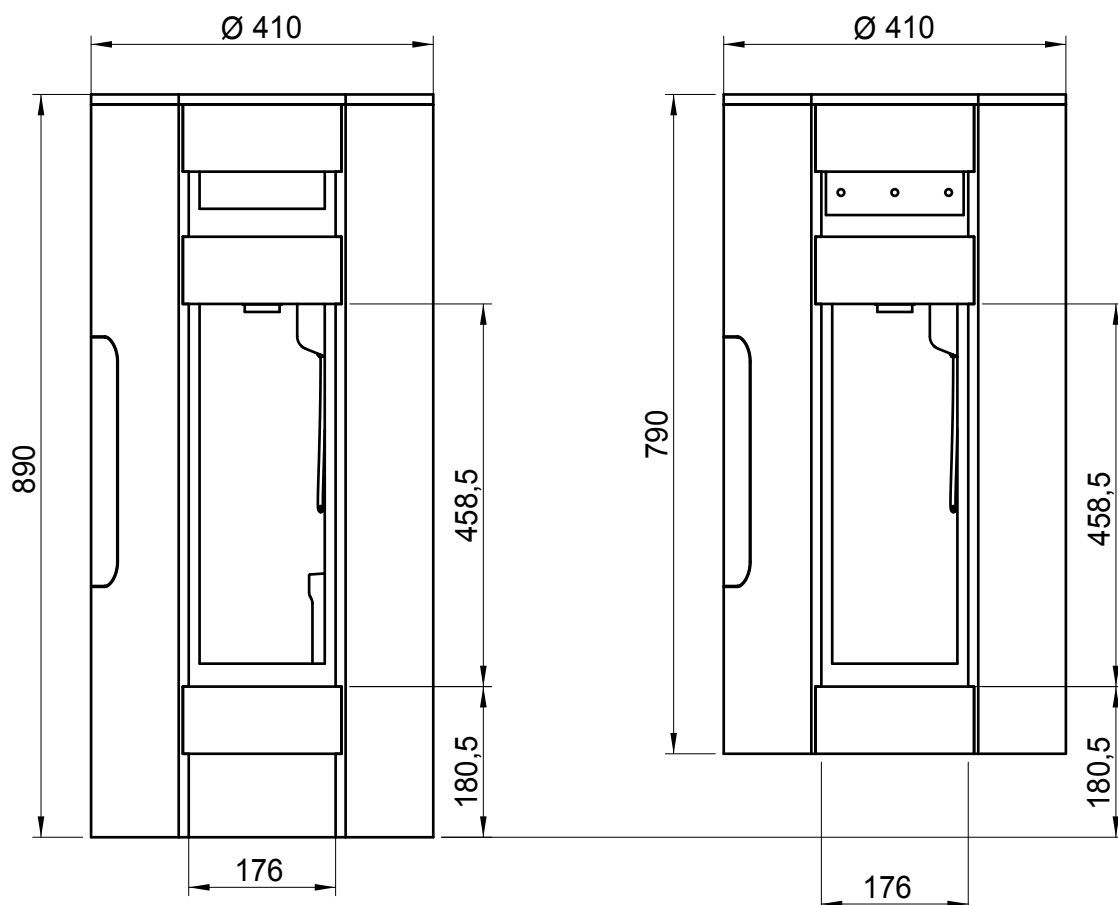

IMPIANTISTICA	MAESTRO	PROF	OPEN BOX SEGGIOLINI	LAVORAZIONI ACCESSORI	LAVELLI RUBINETTI	PIANI ALZATINE	BACINELLE	ARMADI	CART	STERIL K	PURA PURASTUDIO	MOVINGTRAY MOVING ARM	ALA/QUADRO NOVO/UPRIGHT	LIKE	LOOK	VELA
---------------	---------	------	------------------------	--------------------------	----------------------	-------------------	-----------	--------	------	----------	--------------------	--------------------------	----------------------------	------	------	------

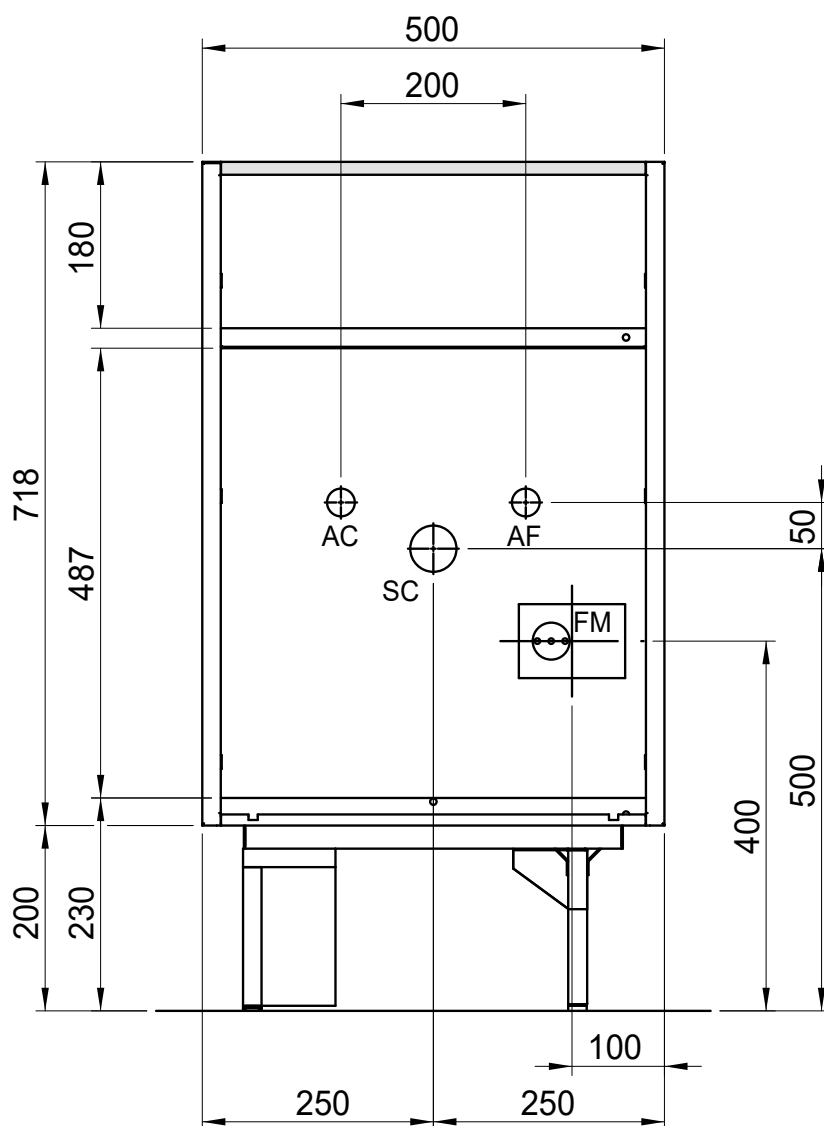

AF

Acqua fredda

Cold water
Eau froide
Kaltwasser
Agua fría

AC

Acqua Calda

Hot water
Eau chaude
Warmwasser
Agua caliente

SC

Scarico

Drainage
Vidange
Abfluss
Desague

FM

Forza elettromotrice

Electrical socket
Prise électrique
Elektrischer Anschluss
Toma eléctrica

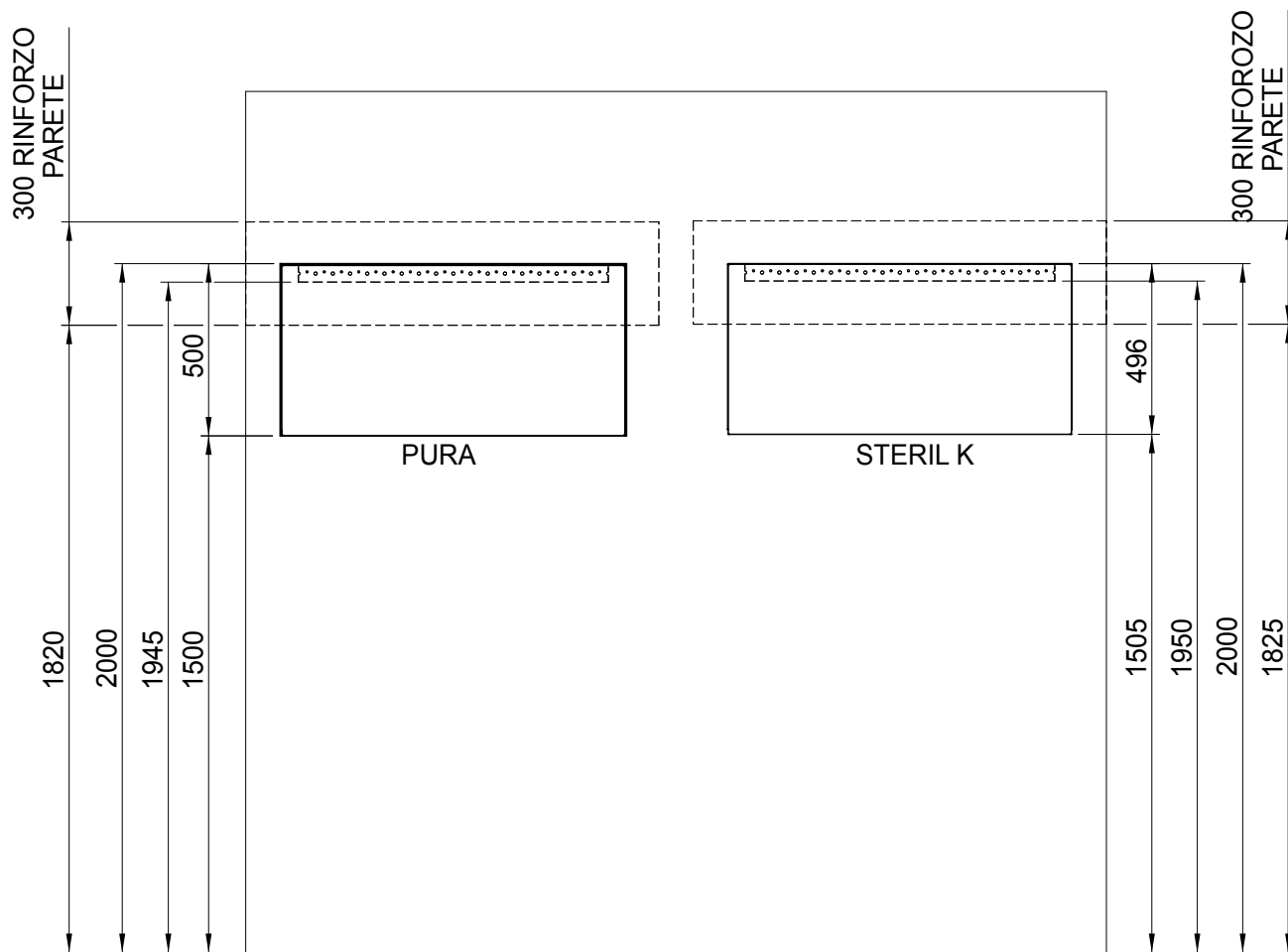

IMPIANTISTICA	MAESTRO	PROF	OPEN BOX SEGGIOLINI	LAVORAZIONI ACCESSORI	LAVELLI RUBINETTI	PIANI ALZATINE	BACINELLE	ARMADI	CART	STERIL K	PURA PURASTUDIO	MOVINGTRAY MOVING ARM	ALA/QUADRO NOVO/UPRIGHT	LIKE	LOOK	VELA
---------------	---------	------	------------------------	--------------------------	----------------------	-------------------	-----------	--------	------	----------	--------------------	--------------------------	----------------------------	------	------	------

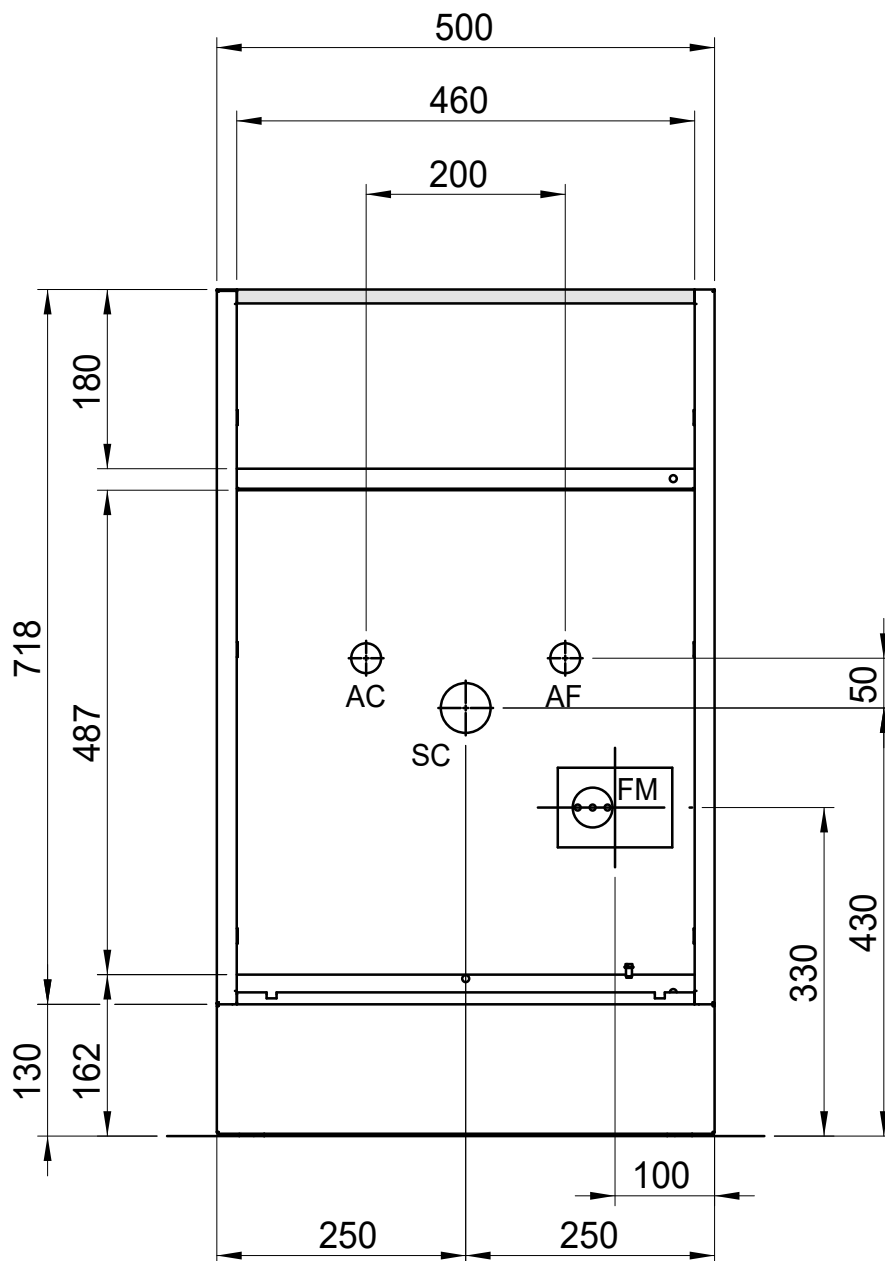

AF

Acqua fredda

Cold water
Eau froide
Kaltwasser
Agua fría

AC

Acqua Calda

Hot water
Eau chaude
Warmwasser
Agua caliente

SC

Scarico

Drainage
Vidange
Abfluss
Desague

FM

Forza elettromotrice

Electrical socket
Prise électrique
Elektrischer Anschluss
Toma eléctrica

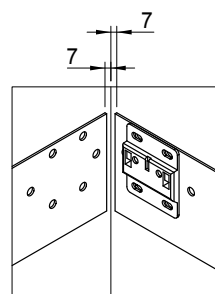
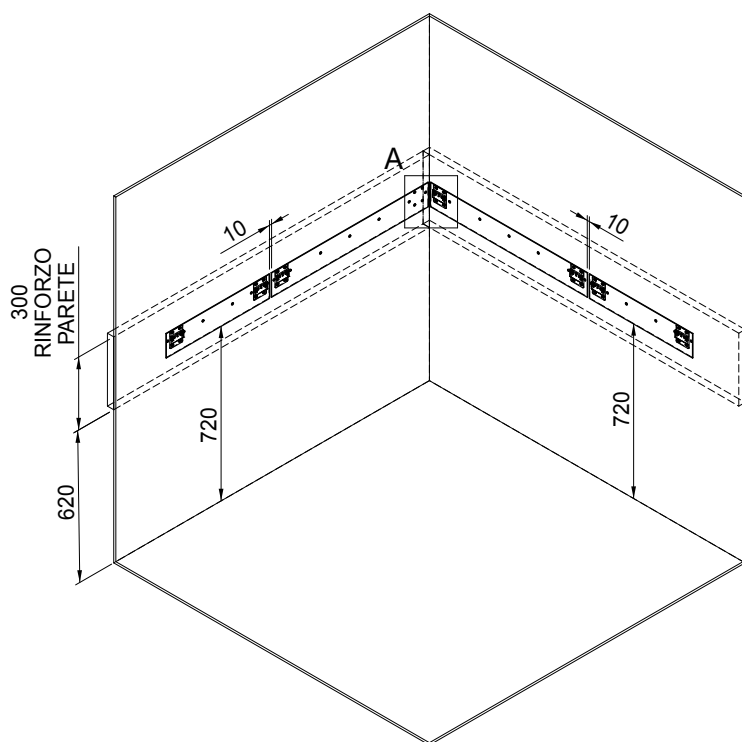

DETTAGLIO A
SCALA 1 : 5

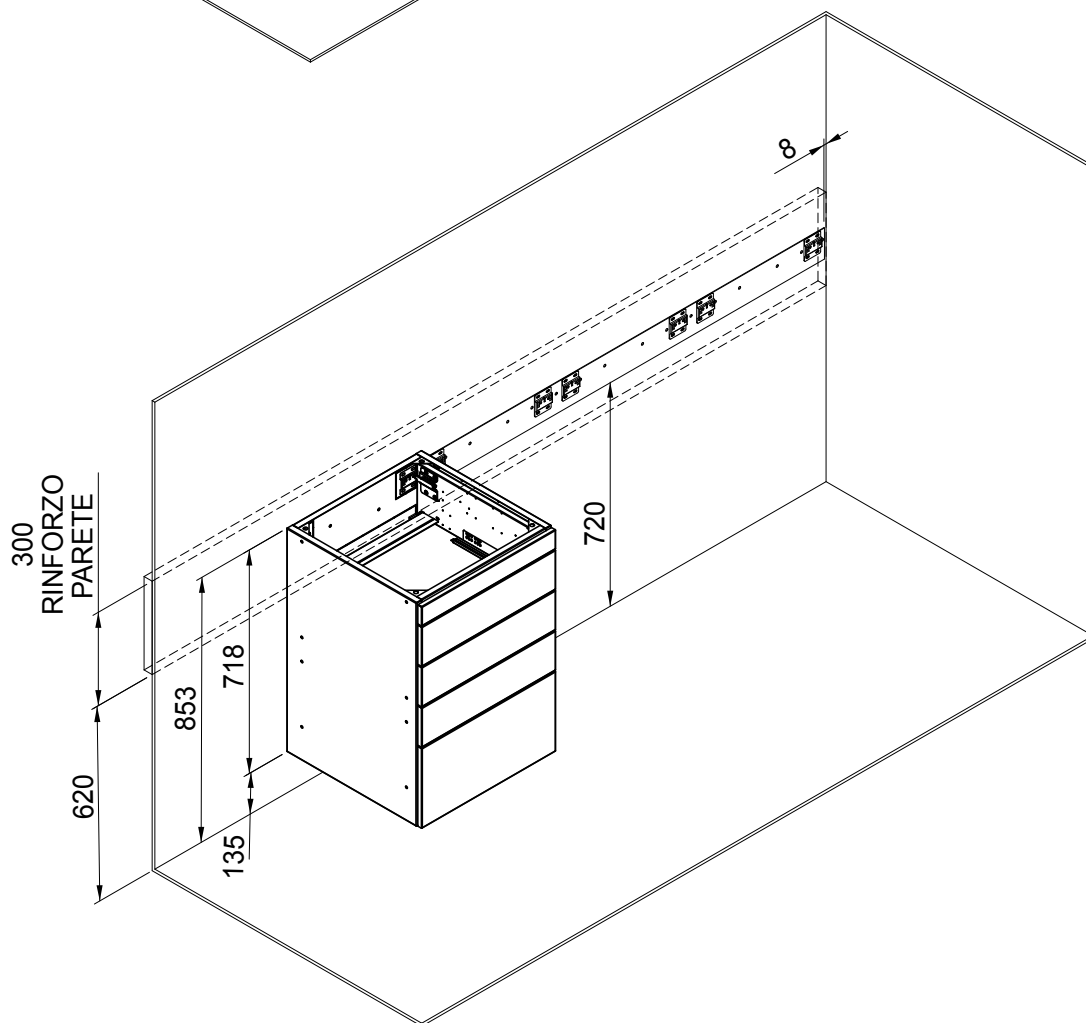

VELA
LOOK
LIKE
ALA/QUADRO NOVO/UPRIGHT
MOVINGTRAY MOVING ARM
PURA PURASTUDIO
STERIL K
CART
ARMADI
BACINELLE
PIANI ALZATINE
LAVELLI RUBINETTI
LAVORAZIONI ACCESSORI
OPEN BOX SEGGIOLINI
PROF
MAESTRO
IMPIANTISTICA

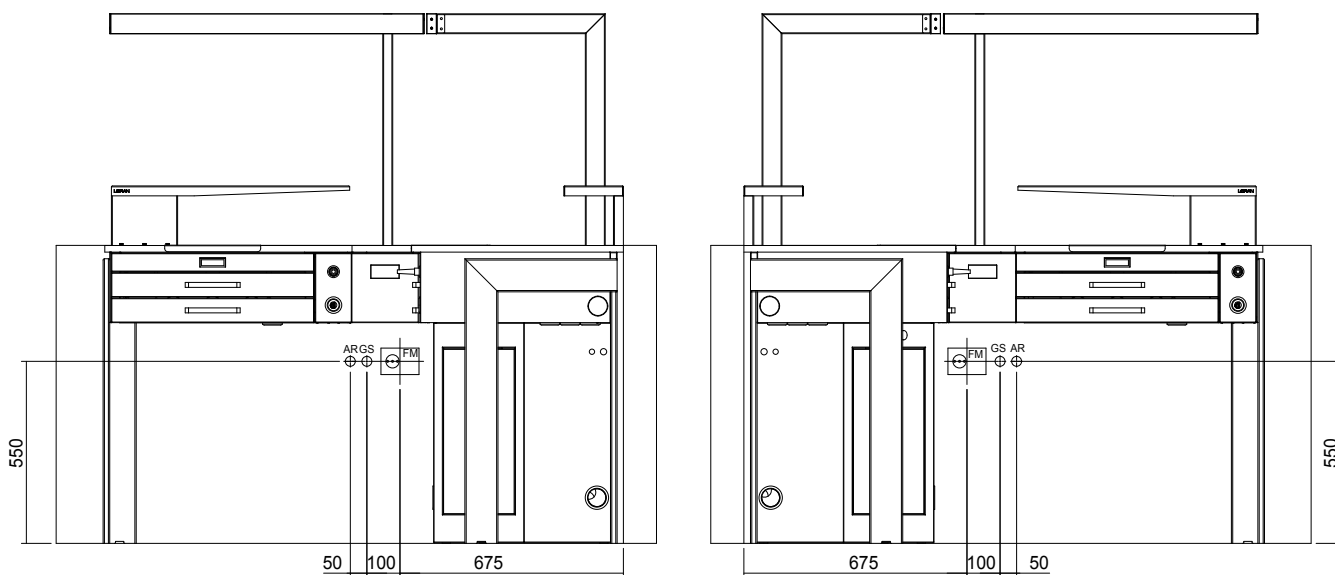
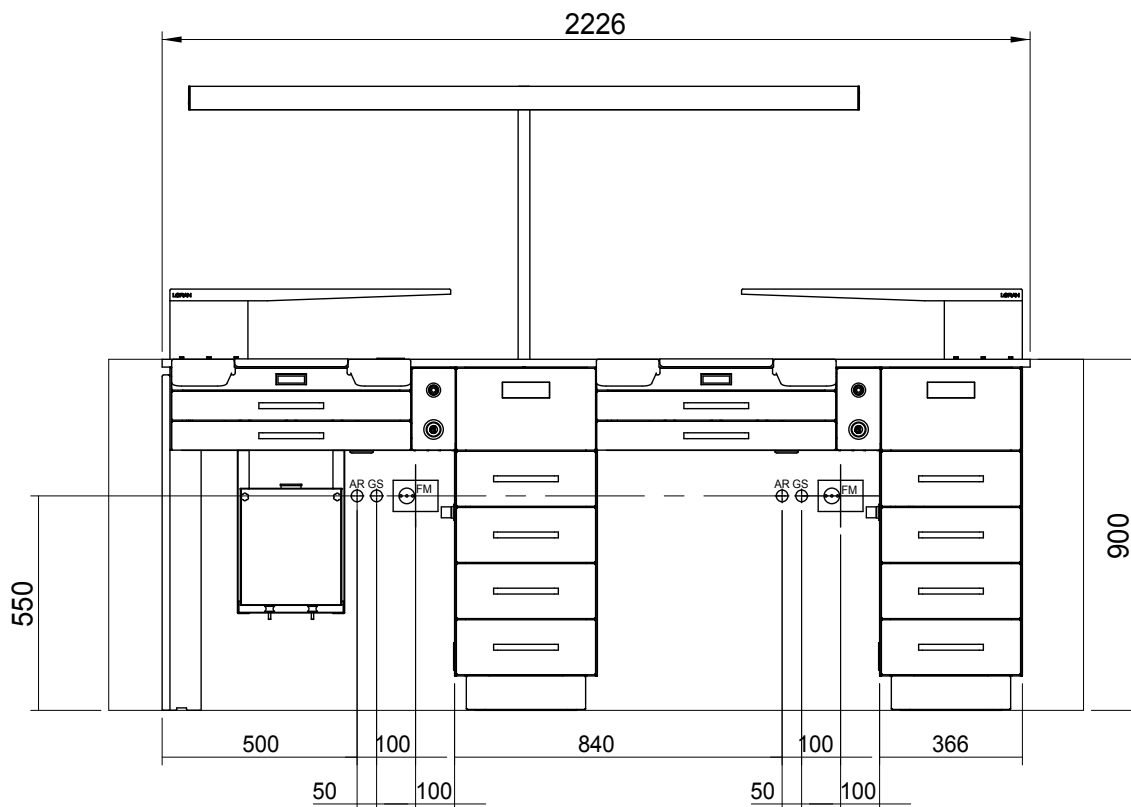

GS

Gas

Gas
Gaz
Gas
Gas

AR

Aria

Air
Air comprimé
Druckluft
Aire

FM

Forza elettromotrice

Electrical socket
Prise électrique
Elektrischer Anschluss
Toma eléctrica

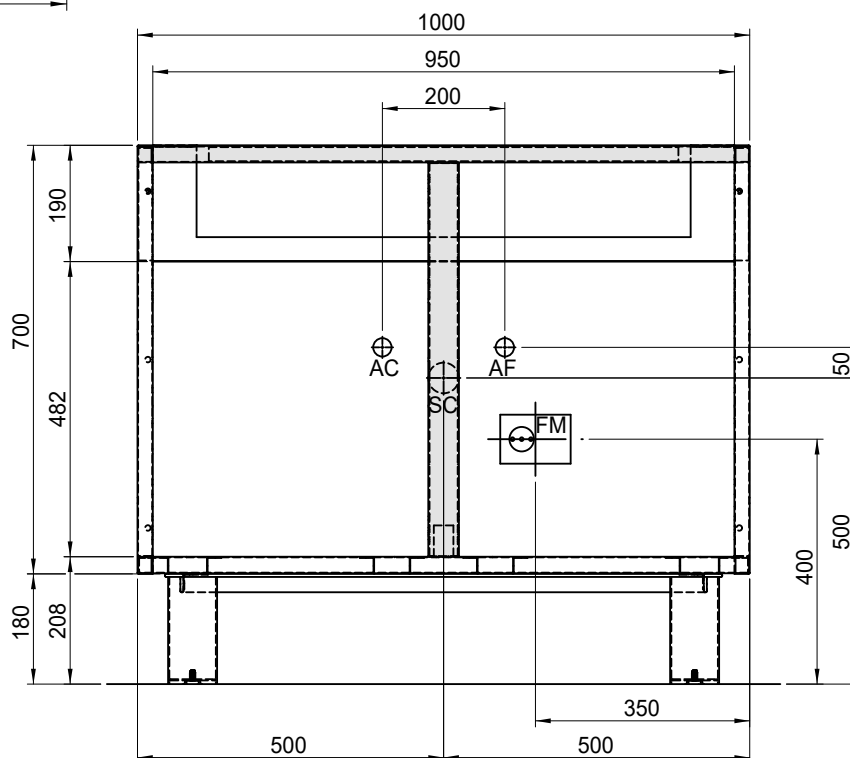
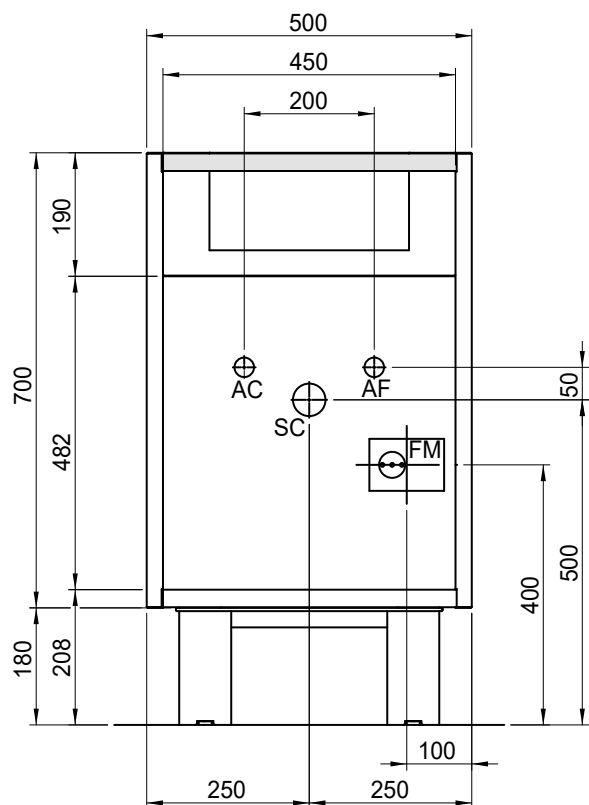

AF

Acqua fredda

Cold water
Eau froide
Kaltwasser
Agua fría

AC

Acqua Calda

Hot water
Eau chaude
Warmwasser
Agua caliente

SC

Scarico

Drainage
Vidange
Abfluss
Desague

FM

Forza elettromotrice

Electrical socket
Prise électrique
Elektrischer Anschluss
Toma eléctrica

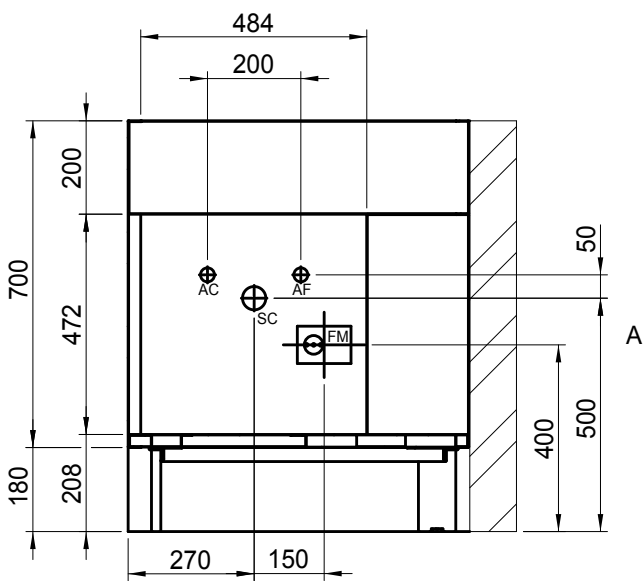

SEZIONE A-A

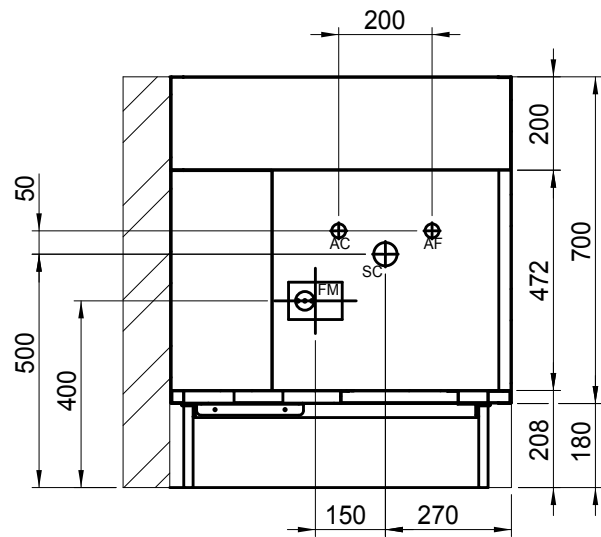

SEZIONE B-B

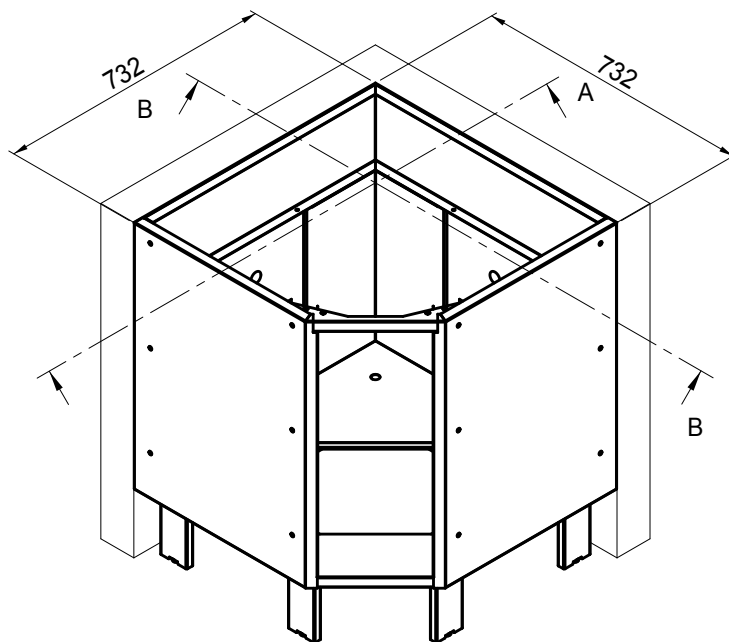

AF

Acqua fredda

Cold water
Eau froide
Kaltwasser
Agua fría

AC

Acqua Calda

Hot water
Eau chaude
Warmwasser
Agua caliente

SC

Scarico

Drainage
Vidange
Abfluss
Desague

FM

Forza elettromotrice

Electrical socket
Prise électrique
Elektrischer Anschluss
Toma eléctrica

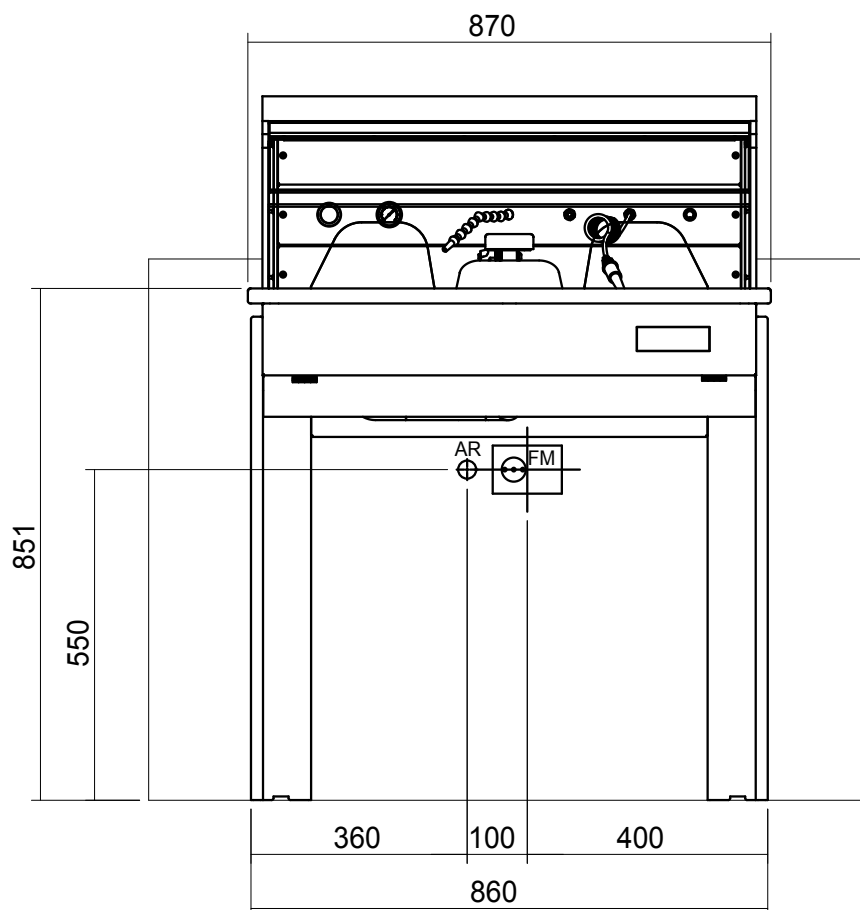
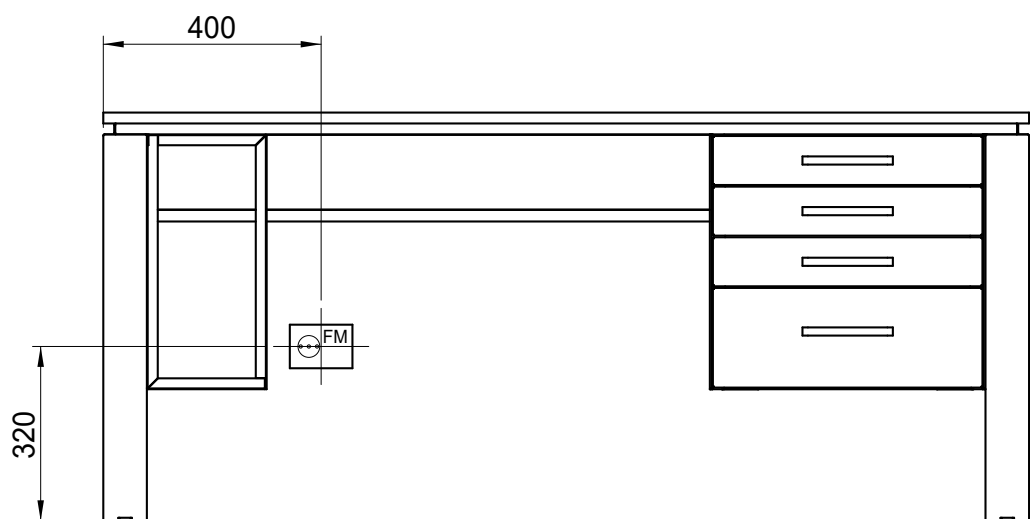

AR

Aria

Air
Air comprimé
Druckluft
Aire

FM

Forza elettromotrice

Electrical socket
Prise électrique
Elektrischer Anschluss
Toma eléctrica

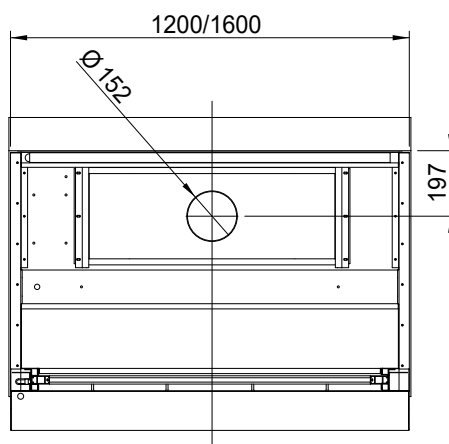
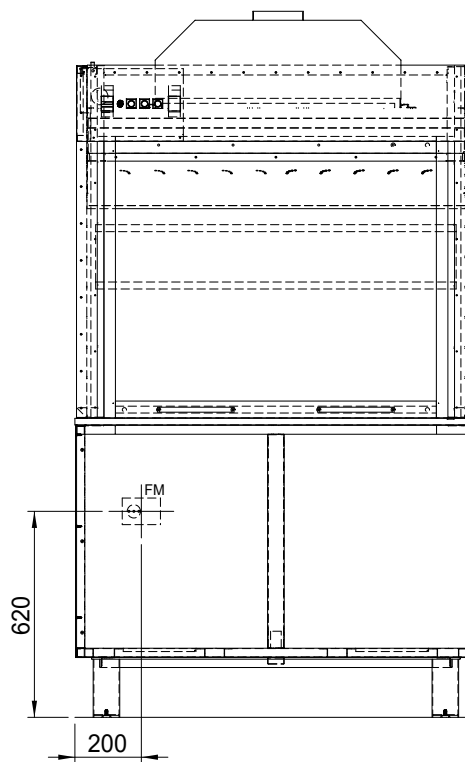
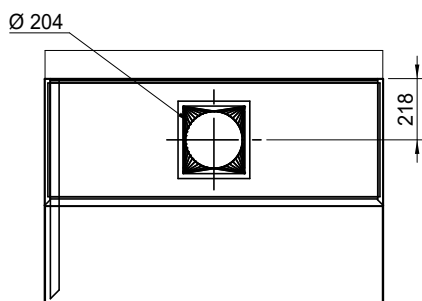
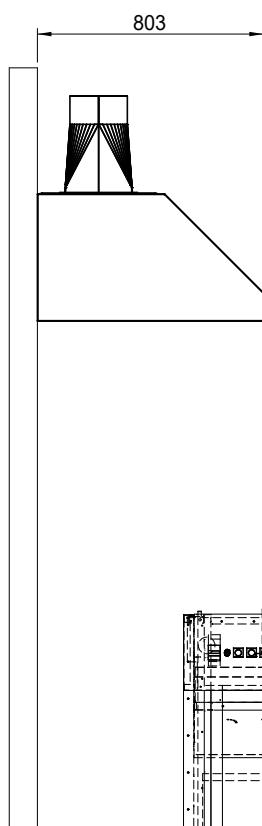
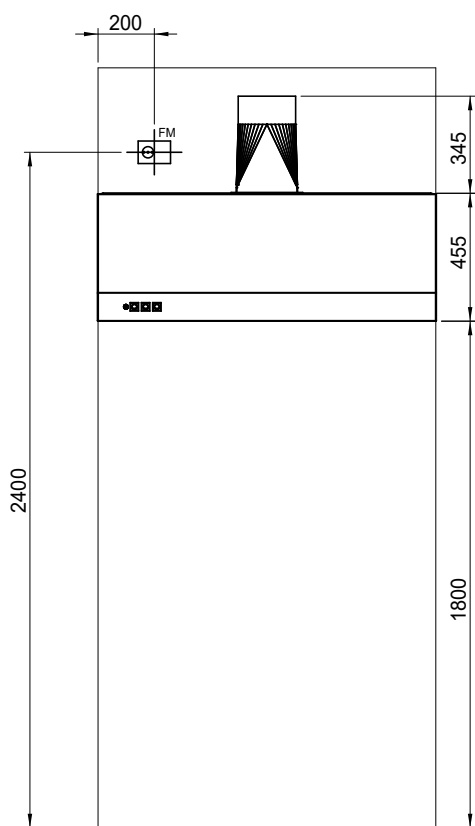

FM

Forza elettromotrice

Electrical socket

Prise électrique

Elektrischer Anschluss

Toma eléctrica

VELA

LOOK

LIKE

ALA / QUADRO
NOVO / UPRIGHT

MOVINGTRAY
MOVING ARM

PURRA
PURASTUDIO

STERIL K

CART

ARMADI

BACINELLE

PIANI
ALZATINE

LAVELLI
RUBINETTI

LAVORAZIONI
ACCESSORI

OPEN BOX
SEGGIOLINI

PROF

MAESTRO

IMPIANTISTICA

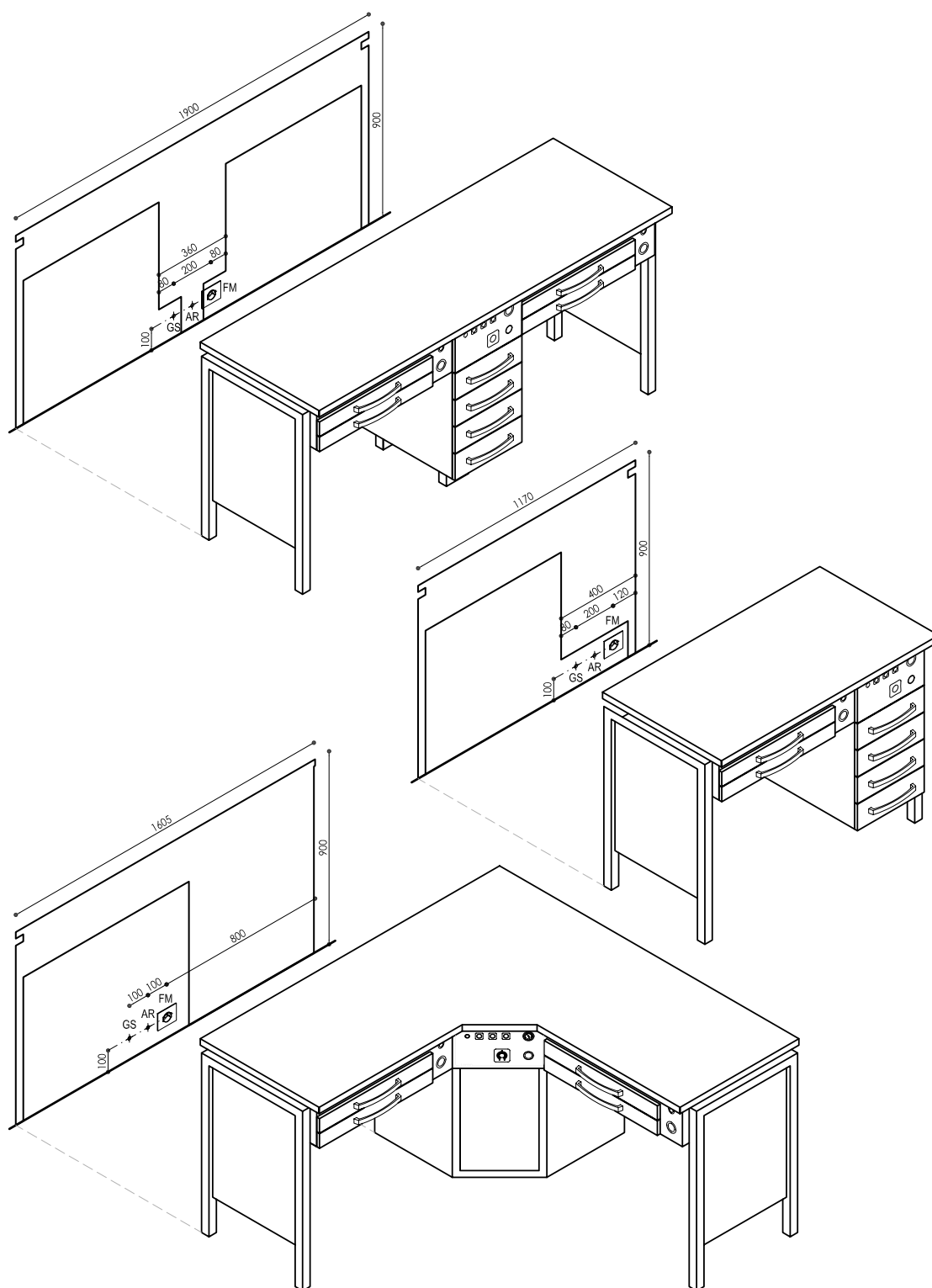

AF

Acqua fredda

Cold water
Eau froide
Kaltwasser
Agua fría

AC

Acqua Calda

Hot water
Eau chaude
Warmwasser
Agua caliente

SC

Scarico

Drainage
Vidange
Abfluss
Desague

GS

Gas

Gas
Gaz
Gas
Gas

AR

Aria

Air
Air comprimé
Druckluft
Aire

FM

Forza elettromotrice

Electrical socket
Prise électrique
Elektrischer Anschluss
Toma eléctrica

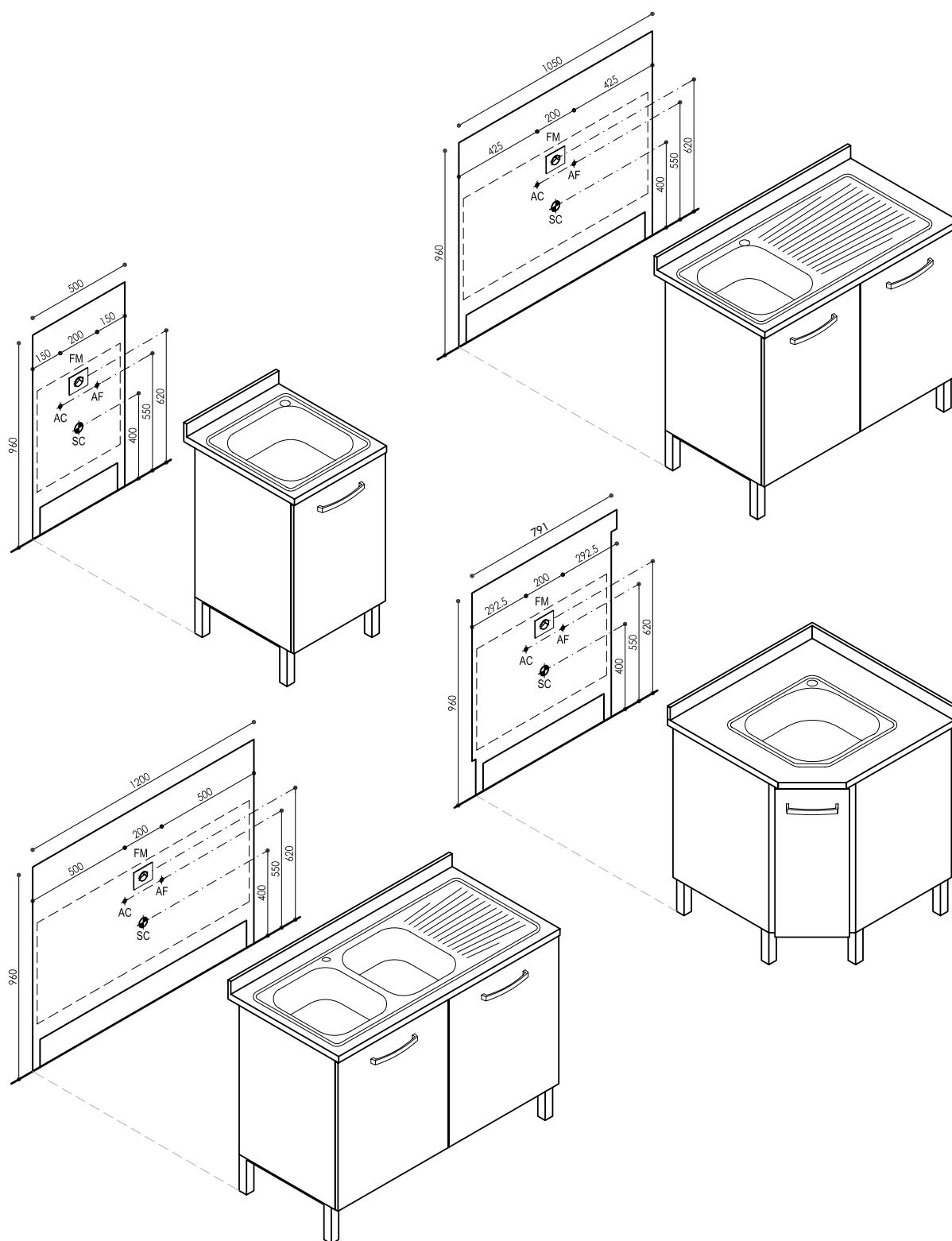

AF

Acqua fredda

Cold water
Eau froide
Kaltwasser
Agua fría

AC

Acqua Calda

Hot water
Eau chaude
Warmwasser
Agua caliente

SC

Scarico

Drainage
Vidange
Abfluss
Desague

FM

Forza elettromotrice

Electrical socket
Prise électrique
Elektrischer Anschluss
Toma eléctrica

VELA

LOOK

LIKE

ALA / QUADRO
NOVO / UPRIGHTMOVING TRAY
MOVING ARMPURA
PURASTUDIO

STERIL K

CART

ARMADI

BACINELLE

PIANI
ALZATINELAVELLI
RUBINETTILAVORAZIONI
ACCESSORIOPEN BOX
SEGGIOLINI

PROF

MAESTRO

IMPIANTISTICA

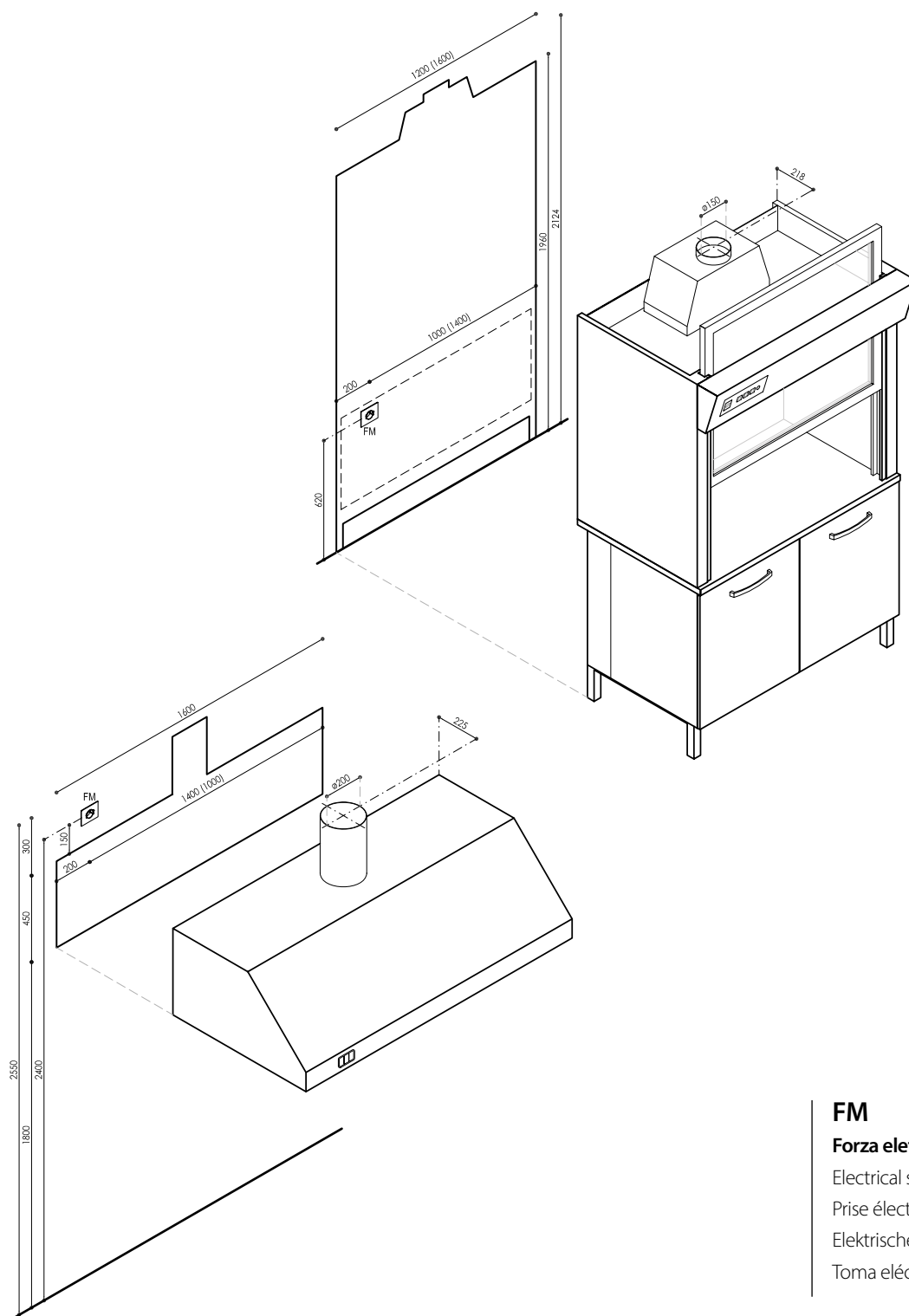

FM

Forza elettromotrice

Electrical socket

Prise électrique

Elektrischer Anschluss

Toma eléctrica



N.B. - Tutti i componenti elettrici dei mobili Loran sono certificati CE.

N.B. - All electrical components of Loran furniture are CE certified.

N.B. - Tous les composants électriques des meubles Loran sont certifiés CE.

Anm. - Alle elektrischen Bauteile der Loran-Möbel sind CE-zertifiziert.

NOTA: Todos los componentes eléctricos de los muebles de Loran están certificados por la CE.

CONDIZIONI GENERALI DI VENDITA

General terms of sale / Conditions generales de vente

Allgemeine Verkaufsbedingungen / Condiciones generales de venta

LORAN

Il presente listino sostituisce e annulla tutti i precedenti e può essere modificato in qualsiasi momento senza preavviso. I prezzi si intendono al netto di iva. **L'imballo non è compreso nel prezzo.** L'installazione è a carico del cliente.

L'ordine, e ogni modifica ad esso, dovrà essere inoltrato per iscritto e sarà da considerarsi accettato solo dopo l'invio di una conferma da parte di Loran srl. I termini fissati per la spedizione non sono tassativi e in nessun caso potranno costituire pretesto per ritardi di pagamento o richiesta di risarcimento.

La merce viaggia a rischio e pericolo del committente, franco stabilimento Loran srl a Pieve di Soligo. Se non indicato per iscritto, la merce sarà spedita col mezzo ritenuto più opportuno da Loran srl. **Eventuali reclami di trasporto devono essere fatti al momento della consegna direttamente al vettore.**

Eventuali difetti di fabbricazione devono essere comunicati a mezzo raccomandata o PEC alla sede Loran srl di Pieve di Soligo entro 8 giorni dalla data di ricevimento merce, anche se segnalati prima in altra forma. In ogni caso non danno diritto al cliente di sospendere i pagamenti.

Nessun materiale dovrà essere reso senza nostra autorizzazione scritta. I resi autorizzati ci dovranno pervenire in porto franco accompagnati da documento di trasporto che indichi il numero e la data della fattura relativa alla fornitura originaria e saranno gravati del 15% per spese generali.

Il materiale di produzione Loran srl ha garanzia di anni cinque, salvo eventuali danni o manomissioni causati dall'utilizzatore.

La merce venduta rimane di proprietà della venditrice fino al pagamento totale da parte dell'acquirente. In caso contrario la venditrice si riserva la facoltà di ritirarla in qualsiasi momento. Ogni controversia sarà competenza del foro di Treviso (Italia)

This price list can be modified at any time, without notice. The prices do not include vat. **Packing is not included in the price.** Installation shall be charged to the customer.

Order as well as any modifications of such orders shall be made in writing and shall be considered accepted upon our written confirmation. Delivery terms are not binding and under no circumstance may they be used as a pretext to justify delays in payment or claims for compensation.

The goods travel at the purchaser's risk on a ex-works basis from our factory in Pieve di Soligo (Italy): unless otherwise specified in writing, the goods will be shipped with the means of transport considered most suitable by our company. The goods shall be checked by the receiver as soon as they reach their destination and **any claim for damages shall be filed directly with the carrier.**

Any manufacturing fault shall be immediately communicated by registered letter or certified e-mail (PEC) to our offices in Pieve di Soligo with in 8 days after the goods have been received, and may also be communicated in other additional ways. By no means shall manufacturing defects entitle the purchaser to stop payments.

No goods shall be returned without our written authorization. Authorized returned goods shall be sent to us free port, together with a "returned goods" note showing the number and date of our original invoice related to such. 15% of total value shall be charged to our customer.

All Loran products are guaranteed for five years. The warranty shall no longer be valid if the product has been damaged or tampered with by the user.

Goods sold remain property of the seller until fully paid by the buyer. Should this not be the case, the seller shall be entitled to withdraw its goods at any time. In the event of any and all disputes, competent court shall exclusively be the court of Treviso (Italy).

VELA

LOOK

LIKE

ALA/QUADRO
NOVO/UPRIGHT

MOVINGTRAY
MOVING ARM

PURRA
PURASTUDIO

STERIL K

CART

ARMADI

BACINELLE

PIANI
ALZATINE

LAVELLI
RUBINETTI

LAVORAZIONI
ACCESSORI

OPEN BOX
SEGGIOLINI

PROF

MAESTRO

IMPIANTISTICA

CONDIZIONI GENERALI DI VENDITA

General terms of sale / Conditions generales de vente

Allgemeine Verkaufsbedingungen / Condiciones generales de venta

LORAN

Cette liste de prix est susceptible d'être modifiée à n'importe quel moment sans préavis. Les prix sont exprimés HT. **Les prix ne comprennent pas l'emballage.** L'installation est à la charge du client.

La commande, et toute modification éventuelle à celle-ci, devra être transmise par écrit et ne pourra être considérée acceptée qu'après l'envoi d'une confirmation écrite de notre part. Les délais fixés pour l'expédition ne constituent pas un terme de rigueur et ne pourront en aucun cas constituer prétexte pour retarder les paiements ou pour exiger un remboursement ou des dommages.

La marchandise voyage aux risques et périls du client, franco départ-usine Loran srl de Pieve di Soligo (Italie): en absence d'instructions écrites précises de la part du client, la marchandise sera envoyée par le moyen que nous jugerons le plus indiqué. **Les éventuelles réclamations concernant le transport devront être faites directement au transporteur au moment même de la livraison.**

Les éventuels défauts de fabrication devront être signalés, par lettre recommandée ou courrier électronique certifié (PEC) dans les 8 jours à compter de la date de réception de la marchandise, à Loran srl de Pieve di Soligo; et cela, même si déjà signalés au travers un autre moyen ou forme. De toute façon, il est entendu qu'une éventuelle réclamation ne donne en aucun cas le droit au client d'interrompre les paiements.

Aucun matériel ne pourra être rendu sans notre autorisation écrite. Les retours autorisés de marchandise devront nous parvenir franco de port et munis d'un bulletin de transport officiel indiquant entre autre le numéro et la date de la facture relative à la commande d'origine. Il est entendu que les marchandises rendues seront grevées de 15% pour cause de frais généraux.

Le matériel de Loran srl production bénéficie d'une garantie 5 ans, sujette à déchéance en cas de dégâts provoqués par l'utilisateur ou, de quelque manière, imputables à celui-ci.

Il est entendu que jusqu'au paiement complet par de l'acheteur de la marchandise vendue, celle-ci reste la propriété de l'entreprise vendeuse qui aura donc la faculté de retirer la marchandise à n'importe quel moment en cas de défaut, même partiel, de paiement. Il est entendu que tout différent ou litige entre les parties sera du ressort du tribunal de Treviso (Italie).

Diese Preisliste kann jederzeit und ohne Vorankündigung geändert werden. Die Preise verstehen sich zuzüglich Mehrwertsteuer. **Die Preise verstehen sich ausschließlich Verpackung.** Die Installation erfolgt auf Kosten des Kunden.

Der Auftrag und jede diesbezügliche Änderung hat schriftlich zu erfolgen und gilt erst nach unserer Auftragsbestätigung als angenommen. Die Lieferdaten sind nicht bindend und berechtigen keinesfalls zu Zahlungsverzögerungen oder Schadenersatzforderungen.

Die Ware reist auf alleinige Gefahr des Auftraggebers ab unserem Firmensitz in Pieve di Soligo (Italien): falls nicht anders schriftlich vereinbart, wird die Ware mit dem von uns als geeignet erachteten Transportmittel befördert. **Eventuelle Beanstandungen bezüglich des Transports sind bei der Anlieferung direkt dem Frachtführer zu melden.**

Fabrikationsfehler sind unserem Firmensitz in Pieve di Soligo innerhalb von 8 Tagen nach Erhalt der Ware per einschreiben zu melden E-Mail (PEC) an unseren Firmensitz in Pieve di Soligo zu melden, auch wenn Sie vorher bereits in anderer Form mitgeteilt wurden. In jedem Fall berechtigen Sie den Kunden nicht zur Einstellung der Zahlungen.

Materialrückerstattungen dürfen nur mit unserer schriftlichen Genehmigung erfolgen. Die genehmigten Rückerstattungen haben Frachtfrei mit einem Transportschein zu erfolgen, auf dem die Rechnungsnummer und das Rechnungsdatum bezüglich der ursprünglichen Lieferung vermerkt sind, wobei 15% für allgemeine Kosten berechnet werden.

Das Material von Loran srl hat eine fünf Jahre Garantie, außer bei Schäden oder unsachgemäßer Behandlung durch den Anwender.

Die verkaufte Ware bleibt Eigentum des Verkäufers bis zur vollständigen Zahlung seitens des Käufers. Andernfalls behält sich der Verkäufer das Recht vor, die Ware jederzeit abzuholen. Für jegliche Streitigkeiten ist das Gericht von Treviso (Italien) zuständig.

La presente lista de precios puede ser modificada en cualquier momento y sin previo aviso. Los precios se consideran sin IVA. **El embalaje no está incluido en el precio.** La instalación está a cargo del cliente.

El pedido, y toda modificación del mismo, se deberá enviar por escrito y se considerará aceptado sólo después del envío de una confirmación por parte de Loran srl. Los plazos fijados para la expedición no son taxativos y en ningún caso podrán constituirse en un pretexto para retrasar el pago o pedir resarcimiento.

La mercancía viaja por cuenta y riesgo del cliente, desde Loran srl en Pieve di Soligo (Italia). Si no estuviera especificado por escrito, la mercancía será enviada por el medio de transporte considerado más conveniente por Loran srl. **Eventuales reclamos por el transporte se deberán realizar en el momento de la entrega directamente al transportista.**

Los defectos de fabricación deberán comunicarse mediante carta certificada o correo electrónico certificado (PEC) a la sede de Loran srl de Pieve di Soligo, dentro de los 8 días a partir de la fecha de recepción de la mercancía, incluso si se comunicaron antes por otro medio. En cualquier caso esto no otorga derecho al cliente para suspender los pagos.

Ningún material podrá entregarse sin nuestra autorización escrita. Las entregas autorizadas deberán realizarse en puerto franco acompañadas por el documento de transporte que indique el número y la fecha de la factura correspondiente al suministro original y estarán gravados con 15% para gastos generales.

El material producido por Loran srl tiene una garantía de cinco años, excepto eventuales daños o alteraciones causados por el usuario.

La mercancía vendida continuará perteneciendo al vendedor hasta el pago total por parte del comprador. En caso contrario el vendedor se reserva la facultad de retirarla en cualquier momento. Toda controversia será competencia de los tribunales de Treviso (Italia).

